



SPECIFICATIONS

Single control  
Chrome  
360° swivel spout  
Anti limescale aerator M 22 x 1  
ø 3/8" stainless steel flexible pipe  
50% two step cartridge for water saving  
Packaging: 56,5 x 29 x 7,1 cm / 0,01163 m<sup>3</sup> / 2,98 kg

CERTIFICATIONS



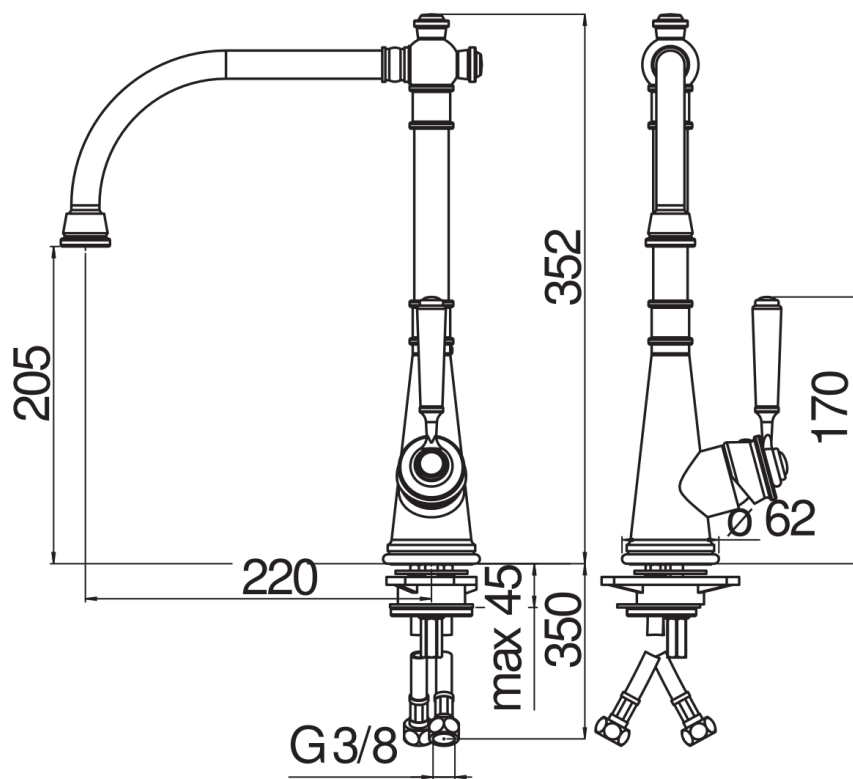

FLOW RATE DIAGRAM: HOT/COLD WATER

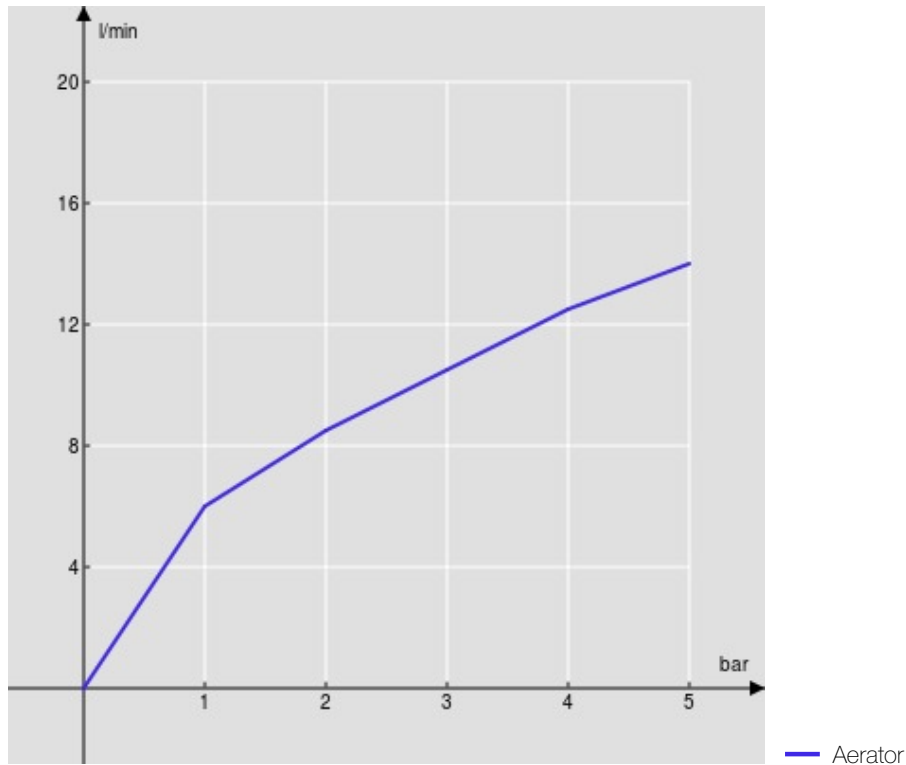

FLOW RATE DIAGRAM: MIXED WATER

