

CATALOGUE

PRO ²⁴/₂₅

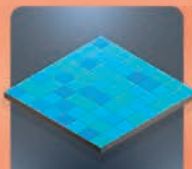

J+0 100% DISPO



RICHARDSON

Eric VACCARO
DIRECTION

Philippe TRAVERSAT
ADJOINT

AUBAGNE

CONTACTS PAR ACTIVITÉ

Chauffage Climatisation

04 42 18 15 00

Salle de Bains

04 42 18 15 04

L'Expo Salle de Bains

04 42 18 15 29

Plomberie - Canalisations

04 42 18 15 05

Tube Aciers - métaux

04 42 18 15 03

Outillage

04 42 18 15 10

Libre-service

04 42 18 15 10

Fax : 04 42 18 91 56

MARSEILLE - JOLIETTE

Plomberie - Sanitaire

Chauffage - Climatisation

04 91 15 48 34

L'Expo Salle de Bains

04 91 15 48 37

MARSEILLE - LA CAPELETTE

Plomberie - Sanitaire

Chauffage - Climatisation

04 91 80 88 70

MARSEILLE - LES AYGALADES

Plomberie - Sanitaire

Chauffage - Climatisation

04 91 43 43 85

LA CIOTAT

Plomberie - Sanitaire

Chauffage - Climatisation

04 42 08 09 41

AIRÉO CAPELETTE

Climatiser - Ventiler - Chauffer

04 65 57 72 26

100% DISPO, Votre agence dès 7h30



L'ATOUT PROXIMITÉ

- Une équipe commerciale expérimentée à votre service.
- Des réponses techniques à vos besoins.
- Notre service de livraison sur vos chantiers.



L'ATOUT EXPERTS

Votre Agence vous propose son expertise dans les domaines d'activités suivants :

Chauffage climatisation

Salle de bains

Plomberie

Énergies Renouvelables

Produits sidérurgiques

Outillage

Carrelage

Électroménager

AUBAGNE - JOLIETTE LA CAPELETTE - LES AYGALADES LA CIOTAT

VOTRE MEILLEUR ATOUT... À TOUT POINT DE VUE !



Les produits à J+0



L'ATOUT STOCK

- **9600 références** des plus grandes marques.
- **100% des produits disponibles** pour répondre efficacement à vos besoins.



L'ATOUT EXPO

Un espace dédié pour concrétiser les projets de vos clients :

- Salle de bains, carrelage, cuisine, chauffage
- Accompagnement sur mesure.
- Conseils, choix, tendances et innovations.



L'ATOUT LIBRE-SERVICE

- Un large choix de produits.
- Tous les produits de ce catalogue à votre disposition.
- Une équipe à votre service.

SOMMAIRE

38



122



140



150



162



198



274



280



290



326



334



362



394



Cahier technique 14

Plomberie : Tubes et Raccords

MULTICOUCHE	38
TUBES MULTICOUCHE ALU	38
RACCORDS MULTICOUCHE A SERTIR	38
RACCORDS MULTICOUCHE A SERTIR ET A VISSER	41

PER	45
TUBES PER	45
RACCORDS PER A SERTIR	45
RACCORDS PER A SERTIR ET A VISSER	46
RACCORDS PER A GLISSEMENT	46
RACCORDS PER A GLISSEMENT ET A VISSER	47

CUIVRE ET LAITON	49
TUBES CUIVRE	49
RACCORDS CUIVRE A SOUDER	49
RACCORDS CUIVRE A SERTIR	52
RACCORDS CUIVRE A SERTIR ET A VISSER	54
RACCORDS LAITON A SOUDER ET A VISSER	56
RACCORDS LAITON A VISSER	59
RACCORDS LAITON RAPIDE	64

COLLECTEUR ET ACCESSOIRES	65
COLLECTEUR SANITAIRE ET CHAUFFAGE	65
COLLECTEUR PLANCHER CHAUFFANT	66

PVC EVACUATION	67
TUBES ET RACCORDS PVC EVACUATION	67
TUBES ET RACCORDS PVC EVACUATION ACOUSTIQUE	77
RACCORDS PVC SANITAIRE	77
AERATION	79
REGARDS, SIPHONS ET CANIVEAUX	80
ASSAINISSEMENT	80

FONTAINE	81
COLONNES ET RACCORDS FONTAINE EVACUATION	81

PVC PRESSION	86
TUBES ET RACCORDS PVC PRESSION	86

PVC PRESSION TECHNIQUE	90
TUBES ET RACCORDS PVC PRESSION EAU CHAUDE	90
TUBES ET RACCORDS PVC PRESSION EAU GLACEE	92

POLYETHYLENE	93
TUBES POLYETHYLENE	93
RACCORDS LAITON POUR PE	93

ACIER	95
TUBES ACIER GALVA	95
RACCORDS ACIER GALVA A SOUDER	96
RACCORDS ACIER GALVA A VISSER	96
RACCORDS ACIER GALVA A SERTIR	97
RACCORDS FONTE MALLEABLE GALVA	97
TUBES ACIER NOIR	102
RACCORDS ACIER NOIR A SOUDER	102
RACCORDS ACIER NOIR A VISSER	104
RACCORDS FONTE MALLEABLE NOIR	105
RACCORDS PETROLE	108
TUBES ACIER ELECTROZINGUE	108
RACCORDS ACIER ELECTROZINGUE A SERTIR	109
RACCORDS ACIER ELECTROZINGUE A SERTIR ET A VISSER	110
RACCORDS DE REPARATION ACIER	111

INOX	112
TUBES INOX	112
RACCORDS INOX A SERTIR	112
RACCORDS INOX A SERTIR ET A VISSER	114
SIPHONS DE SOL/CANIVEAU INOX	115

ISOLATION	116
GAINA ISOLANTE	116
PROTECTION	117

Robinetterie batiment

ROBINETTERIE BATIMENT	122
VANNE A SPHERE LAITON	122
VANNE A SPHERE ACIER-INOX	125
VANNE A SPHERE PLASTIQUE	125
VANNE PAPILLON FONTE	126
AUTRE ROBINETTERIE	126
COMPTEGE ET DETENTE	126
FILTRE	130
CLAPET ET CREPINE	130
DISCONNECTEUR	131
ROBINETTERIE A CLAPET	132
ACCESSOIRES ET EQUIPEMENT SANITAIRE	133
FLEXIBLE DE RACCORDEMENT	135
RACCORD D'ARROSAGE	136
BOUCHE D'ARROSAGE	136
JOINT D'ETANCHEITE	137

Gaz

GAZ	140
TUBES GAZ POLYETHYLENE	140
SELECTION GAZ NATUREL	140
SELECTION GAZ PROPANE	142
SELECTION GAZ BUTANE	143
RACCORDS GAZ CUIVRE A SERTIR	144
RACCORDS TOUS GAZ	145
JOINT GAZ	146
ACCESSOIRES DE POSE POUR GAZ	147

Eau chaude sanitaire

PRODUCTION D'EAU CHAUDE SANITAIRE	150
CHOISISSEZ VOTRE CHAUFFE-EAU ELECTRIQUE	150
CHAUFFE-EAU THERMODYNAMIQUE	151
ACCESSOIRES CHAUFFE-EAU THERMODYNAMIQUE	151
CHAUFFE-EAU ELECTRIQUE	152
CHAUFFE-EAU - CHAUFFE BAIN GAZ	154
GROUPE DE SECURITE ET ACCESSOIRES	155

Chauffage

ECO ENERGIES	162
ACCESSOIRES SOLAIRE /nouveau/	162
CHAUDIERE	162
CHAUDIERE MURALE A CONDENSATION	162
CHAUDIERE MURALE	164
ACCESSOIRES DE CHAUDIERE	165
ACCESSOIRES DE CHAUFFAGE	167
EQUILIBRAGE	167
EXPANSION	167
SECURITE	168
MESURE	168
ACCESSOIRES DE CHAUFFERIE	169
ACCESSOIRES FIOUL	170
TRAITEMENT DES EAUX DE CHAUFFAGE	170

BRULEUR	172
BRULEUR FIOUL - PETITE PUISSANCE	172
ACCESSOIRES DE BRULEUR	172
CIRCULATEUR	172
CIRCULATEUR DOMESTIQUE	172
CIRCULATEUR PETIT COLLECTIF ET COLLECTIF	172
CIRCULATEUR BOUCLAGE ECS	172
ACCESSOIRES DE CIRCULATEUR	173

REGULATION	173
REGULATION ELECTRONIQUE ET MECANIQUE	173

CONDUIT DE FUMEE	176
CHEMINEE	176
VENTOUSE	178
VENTOUSE CONDENSATION	178
ACCESSOIRES DE FUMISTERIE	182

RADIATEUR	184
RADIATEUR ACIER	184
RADIATEUR ALU	184
RADIATEUR DECORATIF	185
RADIATEUR ELECTRIQUE	185
RADIATEUR SECHE-SERVIETTES	185

PLANCHER CHAUFFANT	187
DALLE	187
ACCESSOIRES DE PLANCHER CHAUFFANT	187

ROBINET ET ACCESSOIRES RADIATEUR	188
ROBINET DECOR	188
ROBINET THERMOSTATIQUE	188
ROBINET THERMOSTATISABLE	189
ROBINET MANUEL	190
COUDE, TE DE REGLAGE, RACCORD ET DIVERS	190
ACCESSOIRES RADIATEUR	191

POMPE A CHALEUR	192
POMPE A CHALEUR	192
ACCESSOIRES POMPE A CHALEUR	193

STOCKAGE FIOUL ET ACCESSOIRES	195
ACCESSOIRES FIOUL	195

PIECES DE RECHANGE CHAUFFE-EAU	195
CHAUFFE-EAU	195

Sanitaire - Cuisine

MEUBLE ET PLAN DE SALLE DE BAINS	198
MEUBLE DE SALLE DE BAINS	198
PLAN-VASQUE	199
MIROIR	200
ARMOIRE DE TOILETTE	201

LAVABO, LAVE-MAINS, VASQUE	201
LAVABO/COLONNE	201
VASQUE	202
LAVE-MAINS	202
ROBINETTERIE DE LAVABO/LAVE-MAINS	203
VIDAGE/SIPHON DE LAVABO/LAVE-MAINS	205

DOUCHE	209
RECEVEUR A ENCASTRER	209
RECEVEUR SURELEVE, A POSER	210
RECEVEUR A CARRELER	211
PAROI ET PORTE DE DOUCHE	215
ROBINETTERIE DE DOUCHE	216
ROBINETTERIE ENCASTREE DE DOUCHE	218
VIDAGE/SIPHON DE DOUCHE	219
ACCESSOIRES DE DOUCHE	221

HYDROTHERAPIE	222
COLONNE DE DOUCHE	222
BARRE DE DOUCHE	223
DOUCHETTE	225
FLEXIBLE DE DOUCHE	227
ACCESSOIRES ET SUPPORTS DE DOUCHE	228

BAIGNOIRE	228
BAIGNOIRE EN MATERIAU DE SYNTHESE	228
BAIGNOIRE ACRYLIQUE	229
BAIGNOIRE ACIER	229
TABLIER DE BAIGNOIRE	230
PARE BAIGNOIRE	230
ROBINETTERIE BAIN / DOUCHE	230
VIDAGE/SIPHON DE BAIGNOIRE	233
ACCESSOIRES DE BAIGNOIRE	234

Tout le CataloguePro en 1 coup d'œil !

Sanitaire - Cuisine

ACCESSOIRES DE SALLE DE BAINS	234
GAMME CONFORT	234
GAMME ECONOMIQUE	235
WC	236
BATI SUPPORT WC	236
PACK WC SUSPENDU	238
WC SUSPENDU	240
PACK WC SUR PIED	240
WC SUR PIED	241
RESERVOIR WC	242
MECANISME WC ET ROBINET DE CHASSE	243
ABATTANT WC	245
ACCESSOIRES WC	246
BROYEUR WC	246
ROBINETTERIE HYGIENIQUE	247
BIDET	248
BATI-SUPPORT BIDET	248
ROBINETTERIE DE BIDET	248
VIDAGE ET SIPHON DE BIDET	249
EVIER, MEUBLE CUISINE, KITCHENETTE	249
EVIER INOX	249
EVIER DE SYNTHESE	250
EVIER CERAMIQUE	250
MEUBLE SOUS EVIER	251
ROBINETTERIE CUISINE	252
VIDAGE ET SIPHON CUISINE	255
COLLECTIVITE POINT D'EAU	257
VASQUE, LAVABO ET LAVE-MAINS	257
VIDOIR ET DEVERSOIR	257
ROBINETTERIE COLLECTIVITE POINT D'EAU	258
ACCESSOIRES COLLECTIVITE POINT D'EAU	261
COLLECTIVITE DOUCHE	262
ROBINETTERIE COLLECTIVITE DOUCHE	262
ACCESSOIRES COLLECTIVITE DOUCHE	263
COLLECTIVITE BAIN	263
ROBINETTERIE COLLECTIVITE BAIN	263
COLLECTIVITE ESPACE TOILETTES	264
WC SUSPENDU COLLECTIVITE	264
WC AU SOL COLLECTIVITE	264
URINOIR, STALLE ET SIEGE A LA TURQUE	264
ROBINETTERIE COLLECTIVITE ESPACE TOILETTES	265
COLLECTIVITE CUISINE	266
EVIER, PLONGE ET TIMBRE OFFICE	266
ROBINETTERIE COLLECTIVITE CUISINE	266
ACCESSIBILITE POINT D'EAU	267
PLAN, LAVABO, LAVE-MAINS ACCESSIBILITE	267
ACCESSIBILITE DOUCHE	268
ACCESSOIRES ACCESSIBILITE DOUCHE	268
ACCESSIBILITE ESPACE TOILETTES	268
WC SUSPENDU ACCESSIBILITE	268
PACK WC SUR PIED ACCESSIBILITE	268
ACCESSOIRES ACCESSIBILITE ESPACE TOILETTES	268
PIECES DE RECHANGE SANITAIRE	269
BAIGNOIRE	269
ROBINETTERIE	269
TOILETTES / WC	271

Carrelage

PREPARATION DE SUPPORT	274
PRIMAIRE	274
COLLE ET JOINTS	274
COLLE EN POWDRE	274
COLLE EN PATE	274
JOINTS	275
JOINTS EPOXY	275
PROFILES ET PRODUITS DE FINITION	275
PROFILE	275
ENTRETIEN ET PROTECTION	276
ENTRETIEN	276

Eau - Piscine

POMPAGE	280
SURPRESSEUR DE SURFACE	280
POMPE DE RELEVAGE	280
RESERVOIR, BALLON ET CUVE	281
ACCESSOIRES POUR POMPE	281
TRAITEMENT DES EAUX	282
ADOUCCISSEUR	282
FILTRE	282
ANTITARTRE	282
STERILISATEUR UVC	283
ARROSAGE	283
ARROSAGE MANUEL ET DE SURFACE	283
ARROSAGE ENTERRE	283
PISCINE	284
FILTRATION DE PISCINE	284
PIECES A SCELLER POUR PISCINE	284
NETTOYAGE ET ENTRETIEN DE PISCINE	284
TRAITEMENT DE L'EAU POUR PISCINE	285
ACCESSOIRES POUR PISCINE	286

Climatisation et Ventilation

CLIMATISATION	290
CLIMATISEUR FIXE MONO-SPLIT	290
CLIMATISEUR MONOBLOC <i>[nouveau]</i>	293
CLIMATISEUR FIXE MULTI-SPLIT	293
CLIMATISEUR GAINABLE	295
CLIMATISEUR MOBILE	296
LIAISON FRIGORIFIQUE	296
RACCORDS FRIGORIFIQUE A BRASER	296
RACCORDS FRIGORIFIQUE A SERTIR	298
REGULATION	299
CONDENSATS	300
GOULOTTE	303
PLENUM CLIM	306
PLENUM REGULATION	306
HABILLAGE	307
SUPPORTS ET FIXATIONS	307
ENTRETIEN	308
VENTILATION	311
VMC INDIVIDUELLE AUTOREGLABLE	311
VMC INDIVIDUELLE HYGROREGLABLE	311
VMC COLLECTIVE	312
VMC TERTIAIRE	312
GAINES ET CONDUITS RESIDENTIEL	312
GAINES ET CONDUITS TERTIAIRE	313
GRILLE ET DIFFUSEUR	314
DISTRIBUTION D'AIR ET CONDUITS	316
BOUCHES ET ENTREE D'AIR	320
EXTRACTEUR INDEPENDANT	322

Couverture

COUVERTURE ET ZINGUERIE	326
SELECTION ZINC	326
SELECTION FONTE	327
SELECTION GALVA	327
SELECTION PVC A COLLER	328
SELECTION AUTRES	330

Droguerie Supportage

DROGUERIE	334
COLLE ET MASTIC	334
ETANCHEITE	337
DROGUERIE	340
QUINCAILLERIE	342
SUPPORTAGE ET FIXATION	344
SUPPORTAGE	344
FIXATION	349

Outils

OUTILLAGE PLOMBIER	362
OUTILS DE SERTISSAGE	362
OUTILS DE FAÇONNAGE DU TUBE	363
OUTILS DE SERRAGE	364
OUTILS DE COUPE ET SCIAGE	365
OUTILS DE CINTRAGE	366
OUTILS DE FILETAGE	366
OUTILS D'EBAVURAGE ET CALIBRAGE	366
OUTILS DE SOUDAGE, BRASAGE ET ETANCHEITE	367
OUTILS DE MAINTENANCE ET REPARATION	370
OUTILLAGE CARRELEUR	371
OUTILS DE MALAXAGE	371
OUTILS DE POSE	371
ACCESSOIRES DE POSE	371
ACCESSOIRES DE NETTOYAGE	372
OUTILLAGE FRIGORISTE	372
OUTILS DE RACCORDEMENT	372
CHARGE/DECHARGE DE GAZ	373
OUTILS DE MESURE ET CONTROLE	374
OUTILLAGE UNIVERSEL	375
OUTILS A MAIN	375
RANGEMENT POUR OUTILS	378
OUTILS POUR BATIMENT	379
EQUIPEMENT	379
OUTILLAGE ELECTROPORTATIF	381
OUTILS DE PERÇAGE ET BURINAGE	381
ACCESSOIRES PERÇAGE ET BURINAGE	381
OUTILS DE FORAGE ET CAROTTAGE	384
ACCESSOIRES FORAGE ET CAROTTAGE	384
OUTILS DE COUPE	385
ACCESSOIRES DE COUPE	385
ACCESSOIRES DE CLOUAGE	387
OUTILS SPECIFIQUES	387
MESURE ET CONTROLE	388
OUTILS DE MESURE	388
OUTILS DE CONTROLE	389
SECURITE ET PROTECTION	390
PROTECTION DE LA PERSONNE	390

Electricité et Photovoltaïque

APPAREILLAGE BATIMENT	394
APPAREILLAGE ET ENCASTREMENT	394
CABLES ET CONDUITS	395
CABLES, FIL ET CONDUITS	395
PROTECTION ET DISTRIBUTION	395
DISTRIBUTION ET GESTION DE L'ENERGIE	395
PHOTOVOLTAIQUE	396
FIXATIONS PHOTOVOLTAIQUES <i>[nouveau]</i>	396
ONDULEURS ET CONNECTIQUES <i>[nouveau]</i>	397
KIT PHOTOVOLTAIQUES <i>[nouveau]</i>	397

100% dédié aux pros Leader de la distribution

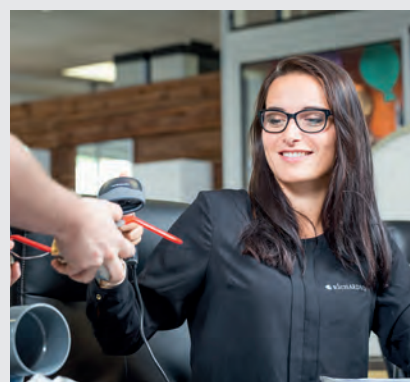

LA SOCIÉTÉ RICHARDSON

Société familiale fondée en 1855, RICHARDSON est un leader dans la distribution de matériel de chauffage, climatisation, salle de bains, plomberie et matières plastiques.

NOS VALEURS

En favorisant la prise d'initiative dans ses équipes et en donnant une forte valeur au capital humain, RICHARDSON a su développer une expertise produits et un conseil adaptés à ses clients.

EN CHIFFRES

170
Ans d'expérience à vos côtés

2000
Collaborateurs

124
Agences en France

72
Salles d'exposition



greensolutions

Votre partenaire énergie



SIMULEZ VOS AIDES EN QUELQUES CLICS



Une **seule démarche** pour bénéficier de l'ensemble des aides éligibles



Une **hotline dédiée** vous accompagne dans vos démarches



Chaque dossier est **contrôlé** pour garantir le paiement des primes



Une **facture allégée** en déduisant l'ensemble des aides éligibles



Toutes les aides éligibles grâce au **simulateur de primes**



Toutes les actualités de la **rénovation énergétique**

Retrouvez chez RICHARDSON les produits éligibles aux aides :



Pompe à chaleur
air/eau



Chauffe-eau
thermo-dynamique



Poêle à
granulés



Chaudière
à bois



VMC simple et
double flux

www.richardson.fr/services/green-solutions

Hotline

06 27 52 64 95

100% PHOTOVOLTAÏQUE À fond les énergies renouvelables !

RECOMMANDEZ LE PHOTOVOLTAÏQUE À VOS CLIENTS



Pour faire des économies d'énergie

Produire sa propre électricité permet de réduire ses factures d'électricité et de s'affranchir des fluctuations de prix.



Pour réduire son empreinte carbone

L'énergie produite par les panneaux photovoltaïques est renouvelable. Ils n'émettent pas de gaz à effet de serre en fonctionnement et permettent ainsi de réduire la pollution de l'air.



Pour investir durablement

Les panneaux photovoltaïques ont une durée de vie de plusieurs décennies et nécessitent peu d'entretien. De plus, la revente de l'électricité au réseau électrique permet de générer des revenus sur le long terme.



Pour améliorer la valeur immobilière de son bien

Investir dans le photovoltaïque permet d'améliorer le diagnostic de performance énergétique (DPE) de sa propriété et ainsi de participer à sa valorisation.

LES FORMATIONS RGE

Pour que vos clients soient éligibles à l'offre EDF OA (vente partielle ou totale), ainsi qu'aux diverses aides et crédits d'impôts, l'installation doit être réalisée par une entreprise RGE. Vous ne l'êtes pas encore ?

Voici les principaux organismes de formation qui délivrent ces certifications :

- ✓ Qualit'ENR
- ✓ QUALIBAT
- ✓ QUALIFELEC

Pas de chantier, sans assurance !



En France, l'assurance décennale est une obligation légale pour toute personne ou entreprise exerçant des activités liées à la construction ou à la rénovation de bâtiments. En cas de dommages elle permet de couvrir les coûts de réparation et de garantir la sécurité et la qualité des bâtiments pour une période de 10 ans. Il n'y a pas de DTU pour cette activité.

Calculer la production,
le coût et la rentabilité
d'une installation solaire
en quelques clics





L'AUTOCONSOMMATION, SIMPLE COMME BONJOUR !

1. L'énergie solaire en courant continu

Le soleil, source de quantité illimitée permet la production d'électricité.

2. Le rôle de l'onduleur

L'électricité continue est transformée en courant alternatif utilisable par tous les équipements domestiques.

3. Autoconsommation instantanée

L'électricité produite alimente les circuits électriques du logement immédiatement

4. Alimentation des pompes à chaleur et chauffe-eau thermodynamique

Pour la climatisation, le chauffage, l'eau chaude sanitaire...pour une maison autonome qui privilégie le confort.

5. Faites travailler le soleil

Selon le modèle économique, l'électricité peut être stockée dans des batteries pour les moments de faible production, ou encore injectée dans le réseau pour revente selon des tarifs encadrés par l'État ou sous forme de batterie virtuelle.

DÉCOUVREZ LE CATALOGUE PHOTOVOLTAÏQUE

**Faites vous guider
vers l'autonomie
énergétique !**



100% HAPPY

Des promos qui percutent !



Faites le plein de cadeaux !

Cumulez les jetons Happy en choisissant vos cadeaux sur www.happy-richardson.fr
100€ achetés dans votre libre service = 1 JETON HAPPY



La promo du mois

De mars à novembre, découvrez les Happy Promos tout au long de l'année.



En avant les promos !

Retrouvez une sélection de produits de vos marques préférées et profitez des promos multi-produits.



Les promos de la saison

Une sélection de tous les meilleurs produits de la saison

100% CONNECTÉ
à votre agence !

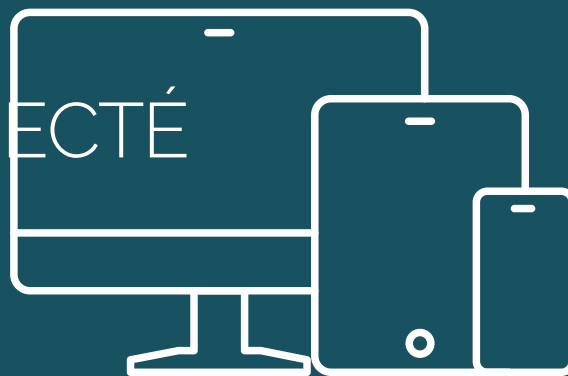

VOTRE ESPACE PRO, LA CLÉ DE TOUS VOS SUCCÈS !

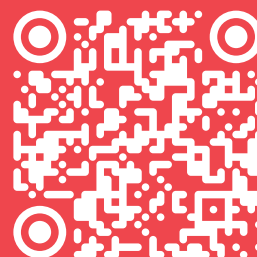

MON ESPACE PRO



Devis, factures
et suivi de commandes



Actus promos
et déstockages



Services dédiés
aux pros



Guides et conseils



Accès aux
Gammes Exclusives



Téléchargement
de nos catalogues

www.richardson.fr

100% EXCLUSIVITÉS Seulement pour vous !

TEKNIK

La marque du pro

Des produits indispensables à votre quotidien au meilleur prix, sans concurrence internet et toujours disponibles dans votre agence...

TEKNIK, la marque du pro

- Bâti-support
- Vidages et siphons
- Robinetterie de radiateur
- Vase d'expansion
- Platine de fixation de robinetterie sanitaire PER et multicouche.
- Pieds de receveur

Offres réservées aux professionnels, prix publics HT



TECE:

Intelligente Haustechnik



CGS groupe NOBILIT



RBM



GITRAL
SPECIALISTE FRANÇAIS DES VASES D'EXPANSION

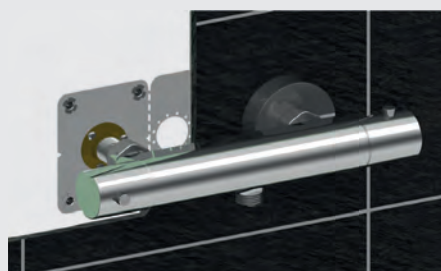

ANQUIER



LAZER
L'innovation en action

100% EXCLUSIVITÉS Seulement pour vous !

Des prix attractifs, des produits et pièces détachées disponibles rapidement, la qualité des grandes marques, pas de concurrence internet...

eaZY

Le meilleur atout des PROS...



LES EXCLU' DU PRO 2024

Nos exclusivités sanitaire, chauffage et plomberie dans un unique catalogue

TEKNIK eaZY Metropolitan



NOUVEAU

Offres réservées aux professionnels, prix publics HT

100% EXCLUSIVITÉS Pour vos clients !

Des collections pour prendre soin de vos clients

Des exclusivités, toujours issues d'une collaboration étroite avec nos fabricants !
Nous proposons des produits exclusifs pour toujours plus de choix, de liberté et de satisfaction.

Metropolitan Les gammes *essentiels*

Une ligne de produits incontournables et fonctionnels au meilleur rapport qualité/prix.



Retrouvez nos gammes dans
notre catalogue Collections
Exclusives 2024



100% EXCLUSIVITÉS Pour vos clients !

UPcity Les gammes *tendances*

Une ligne de produits tendances pour satisfaire vos envies avec un budget maîtrisé.

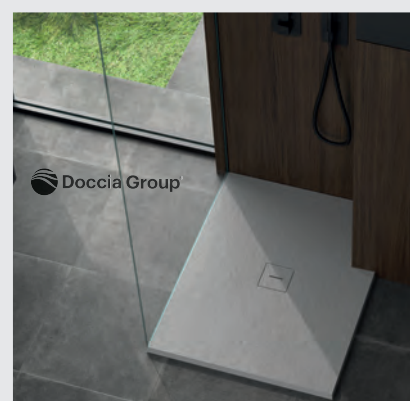
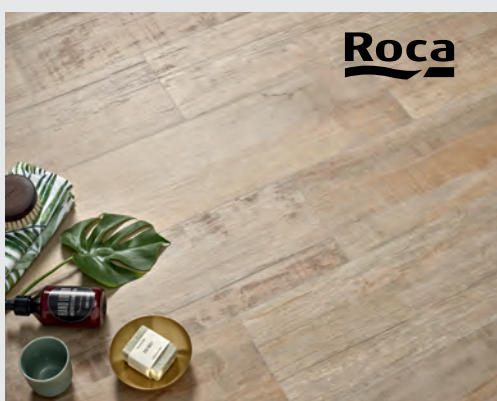
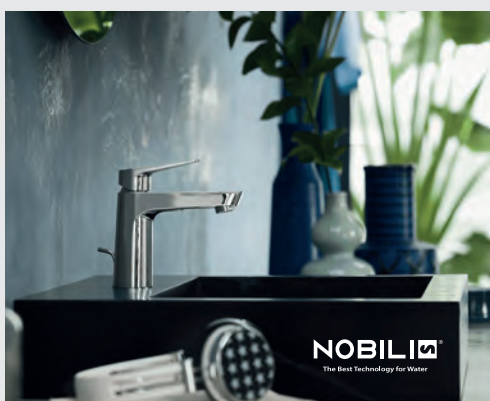

Sign Les gammes *design*

Une ligne de produits esthétiques au design de caractère.







RACCORDS ET TUBES

TABLEAU DIMENSIONNEL			TUBES, RACCORDS À SOUDER	
			Ø EXTÉRIEUR	PÉRIMÈTRE
DN	POUCE	mm	mm	
8	1/4"	8x13	13.5	42.4
10	3/8"	12x17	17.2	54
15	1/2"	15x21	21.3	66.9
20	3/4"	20x27	26.9	84.5
25	1"	26x34	33.7	105.9
32	1"1/4	33x42	42.4	133.2
40	1"1/2	40x49	48.3	151.7
50	2"	50x60	60.3	189.4
65	2"1/2	66x76	76.1	239
80	3"	80x90	88.9	279.2
100	4"	100x108	108	339.2
100	4"	102x114	114.3	359
125	5"	125x133	133	417.8
125	5"	125x140	139.7	438.8
150	6"	150x160	159	499.4
150	6"	150x170	168.3	528.7
250	8"	250x275	273	857.5
300	12"	300x324	323.9	1017.4
350	14"	350x356	355.6	1117
400	16"	400x406	406.4	1276.6

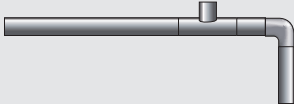
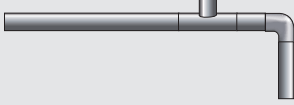
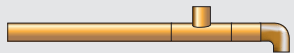
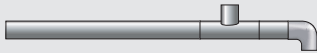
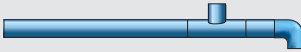
RACCORDS ET TUBES

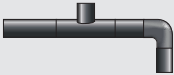
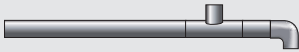
RÉCAPITULATIF DES NORMES (TUBES)

TYPE DE CANALISATION		NORME*
ACIER		NF EN-10255-W (tarif 1) NF EN-10255-S (tarif 3) NF EN-10216-1 (tarif 10)
ACIER GAZ		NF EN-10216-1 (nuance P195TR2 ou P235TR2) NF EN-10216-2 (nuance P195GH ou P235GH) NF EN-10217-1 (nuance P195TR2 ou P235TR2) NF EN-10217-2 (nuance P195GH ou P235GH) NF EN-ISO-3183 (nuance L245NE ou L290NE et L245ME ou L290ME)
CUIVRE		NF EN-1057
INOX		NF A 35.574
P.E.R.		NF EN-1264
MULTICOUCHE		EN ISO 21003 NF 545
POLYÉTHYLÈNE		NF T 54-065 (gaz) NF T 54-063 (eau)
P.V.C.		NF T 54-016 (pression) NF EN-1329-1 (évacuation)
FONTE		NF EN-877

* Sous réserve de modification de la part des organismes normatifs.

RACCORDS ET TUBES

ISOLATION DES CANALISATIONS

La RT2012 recommande des épaisseurs d'isolants en fonction du diamètre de la tuyauterie et de sa destination, chauffage ou eau glacée (Norme EN 12828)

Diamètre Canalisation (mm)	CHAUFFAGE Temps du fluide +60°C – Temps Ambiante +10°C		EAU GLACÉE Temps du fluide +7°C – Temps Ambiante +26°C	
	CLASSE 2	CLASSE 4	CLASSE 3	CLASSE 4
	Épaisseur de l'isolant (mm)	Épaisseur de l'isolant (mm)	Épaisseur de l'isolant (mm)	Épaisseur de l'isolant (mm)
Ø 06	9	9	13	13
Ø 08	9	9	13	13
Ø 10	9	13	13	13
Ø 12	9	13	13	13
Ø 15	9	19	13	19
Ø 18	13	19	13	19
Ø 20	13	25	19	19
Ø 22	13	25	19	25
Ø 25	19	32	19	25
Ø 28	19	32	19	32
Ø 32	19	32	25	32
Ø 35	19	40	25	32
Ø 42	25	40	32	40
Ø 48	25	50	32	40
Ø 54	25	50	32	50
Ø 60	32	50	32	50
Ø 64	32	50	40	50
Ø 70	32	50	40	50
Ø 76	32	60	40	50
Ø 80	32	60	40	50
Ø 89	32	60	40	60
Ø 102	32	60	40	60
Ø 108	32	60	40	60
Ø 114	32	60	50	60
Ø 125	40	32 + 32	50	60
Ø 133	40	32 + 32	50	60
Ø 140	40	32 + 32	50	60
Ø 160	40	32 + 32	50	60
Ø 168	40	40 + 25	50	32 + 32

CLASSE 2 : pour les bâtiments traditionnels en neuf et rénovation Chauffage

CLASSE 3 : pour les bâtiments traditionnels en neuf et rénovation Eau glacée

CLASSE 4 : pour les bâtiments Basse Consommation ou à Haute Performance Énergétique

EMPREINTES MÂCHOIRES À SERTIR



TABLEAU DE CORRESPONDANCE PAR MARQUE

SÉLECTION FABRICANT	ÉLECTROZINGUÉ	INOX	CUIVRE	MULTICOUCHE	P.E.R.
AIPS	Acier XPRESS M	Inox XPRESS M	SUDOPRESS V		
COMAP				SKINPRESS TH	PEXPRESS RFz
GEBERIT	Mapress Acier Carbone Mapress*	Mapress Acier Inoxydable Mapress*	Mapress Cuivre Mapress*	Mepla / Volex Mepla* / TH ou U	
GIACOMINI				Raccord RM H / TH / U	
IBP	>B< Press V	>B< Press V	>B< Press V		
MULTITUBO				Empreinte U	
NICOLL				Fluxo® TH	
PB TUB	SERTI-STEEL M			Pbtub Alpex-duo et Turatec F / TH	Sertipress RFz
RBM				RBM TITA FIX TH	
REHAU TUBE				RAUTHERM Multi Rautool*	RAUTHERM PE-Xa Rautool*
RIQUIER ADRIEN					RIQUIER À SERTIR H / RFz / TH
SANHA	SANHA-Therm SA / M / V	NiroSan / NiroTherm SA / M / V	SANHA-Press SA / M / V	3fit-Press TH	
TECE				TECElogo Système Pushfit*	
				TECEflex Système à glissement*	
THERMACOME				AQUACOME ACOPEX ALU TH / H / U	ACOME MT ACz
TIEMME				COBRA-PRESS TH / H / U	
UPONOR				Unipipe Unipipe*	
VALSIR				Plexalbrass / Bravopress H / TH / U / C	
VIEGA	Prestabo V	Sanpress Inox V	Profipress V	Smartpress VX	
WAVIN				TIGRIS M1 U	

* Empreinte propre à la marque fournisseur

ALIMENTATION SANITAIRE

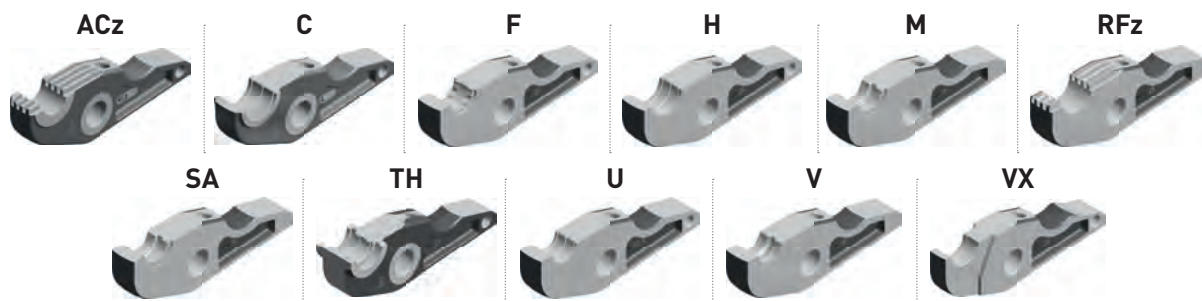
Le DTU 60.11 définit entre autre le diamètre des canalisations d'alimentation en eau à mettre en œuvre en fonction de l'appareil à raccorder à l'alimentation sanitaire.

Le tableau 1 ci-dessous indique les débits minimaux (en l/s) à prendre en considération pour le calcul des installations d'alimentation ainsi que les diamètres intérieurs mini des canalisations d'alimentation (en mm) des appareils pris individuellement.

DÉSIGNATION DE L'APPAREIL	Q _{min} DE CALCUL ⁽¹⁾		DIAMÈTRES INTÉRIEURS MINI DES CANALISATIONS D'ALIMENTATION ⁽²⁾ (mm)
	EAU FROIDE OU EAU MÉLANGÉE (l/s)	EAU CHAUDE (l/s)	
Lavabo	0,20	0,20	10
Lavabo collectif (par jet)	0,05	0,05	Suivant nombre de jets
Bidet	0,20	0,20	10
Baignoire	0,33	0,33	13
Douche	0,20	0,20	12
Poste d'eau robinet 1/2	0,33		12
Poste d'eau robinet 3/4	0,42		13
WC avec réservoir de chasse	0,12		10
WC avec robinet de chasse	1,50		Au moins le diamètre du robinet
Urinoir avec robinet individuel	0,15		10
Urinoir à action siphonique	0,50		Au moins le diamètre du robinet
Lave-mains	0,10		10
Évier – timbre d'office	0,20	0,20	12
Bac à laver	0,33		13
Machine à laver le linge	0,20		10
Machine à laver la vaisselle	0,10		10
Machine industrielle ou autre appareil	Se conformer à l'instruction du fabricant		

- Lorsque la production d'eau chaude est individuelle, ces débits servent de base au calcul des diamètres des canalisations d'eau froide à usage collectif et des canalisations intérieures jusqu'au piquage alimentant l'appareil de production d'eau chaude.
- Ces diamètres tiennent compte des conditions d'utilisation des divers appareils sanitaires.

INSTALLATIONS INDIVIDUELLES :

DIAMÈTRE INTÉRIEUR MINIMAL D'ALIMENTATION EN FONCTION DU NOMBRE D'APPAREILS

Chaque appareil individuel est affecté d'un coefficient suivant le tableau ci-dessous. La somme des coefficients permet avec le graphique de déterminer le diamètre minimal d'alimentation du groupe d'appareils, à partir de deux appareils.

Lorsque le total des coefficients est supérieur à 15, il y a lieu de calculer, comme pour les parties collectives, selon la formule de Flamant.





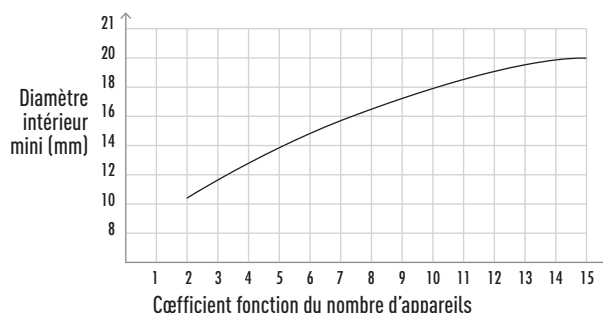

APPAREILS	COEFFICIENTS	
WC (avec réservoir de chasse), lave-mains, urinoirs, siphon de sol	0,5	
Bidet, WC à usage collectif, machines à laver (linge ou vaisselle)	1	
Lavabo	1,5	
Douche, poste d'eau	2	
Évier, timbre d'office	2,5	
Baignoire	≤ 150 l de capacité	3
	> 150 l	3 + 0,1 par tranche de 10 litres supplémentaires

DIAMÈTRE INTÉRIEUR MINIMAL D'ALIMENTATION EN FONCTION DU NOMBRE D'APPAREILS PARTIES INDIVIDUELLES



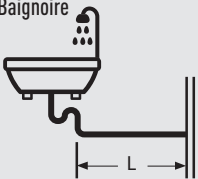
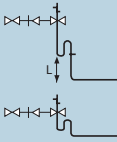

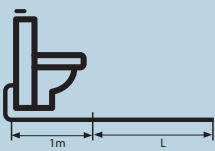

ÉCOULEMENT SANITAIRE

Évacuation individuelle d'appareils. La pente recommandée est de 1 cm/m.

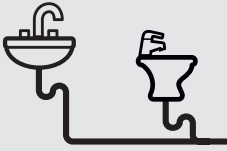
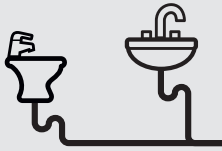
APPAREIL	Ø INTÉRIEUR MINIMAL (mm)	OBSERVATIONS
Lavabo, lave-mains, bidet 	30	
Évier, poste d'eau, douche, urinoir 	33	
Baignoire 	33	Si L < 1 m
	38	Si L > 1 m
Groupe de sécurité 	20	Si L ≥ 1 m
	25	Sans partie verticale ou L < 1 m
Machine à laver : linge, vaisselle 	33	
WC à action siphonique 	60	Sur longueur de 1 m
	77	Sur partie L supérieure à 1 m
WC à chasse directe 	80	

Les diamètres indiqués dans ce tableau sont prévus pour des pentes de canalisation comprises entre 1 et 3 cm/m.

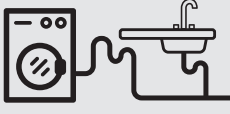
APPAREILS GROUPÉS DANS LE SENS DE L'ÉCOULEMENT	Ø INTÉRIEUR MINIMAL (mm)	OBSERVATIONS
Lavabo + bidet 	30	
Bidet + lavabo 		
Lavabo ou bidet ou machine à laver + baignoire 		2 vidanges séparées sont nécessaires (voir tableau ci-dessus)
Baignoire + lavabo ou bidet ou machine à laver 		Choisir le diamètre immédiatement supérieur au diamètre de l'appareil le plus important
Lavabo + bidet + baignoire (ordre indifférent) 		2 collecteurs sont nécessaires (voir cas précédents). Le diamètre minimal dépend du regroupement des appareils
Machine à laver (linge ou vaisselle) + évier 	33	

- Une douche peut être assimilée à une baignoire.
- Lorsque des appareils sanitaires sont en attente, on dimensionne les collecteurs en prenant les mêmes hypothèses que s'ils existaient.

Les diamètres indiqués dans ce tableau sont prévus pour des pentes de canalisations comprises entre 1 et 3 cm/m.

NORMES ÉLECTRIQUES NFC15-100 POUR LA SALLE DE BAINS

POUR BAIGNOIRE OU DOUCHE AVEC RECEVEUR

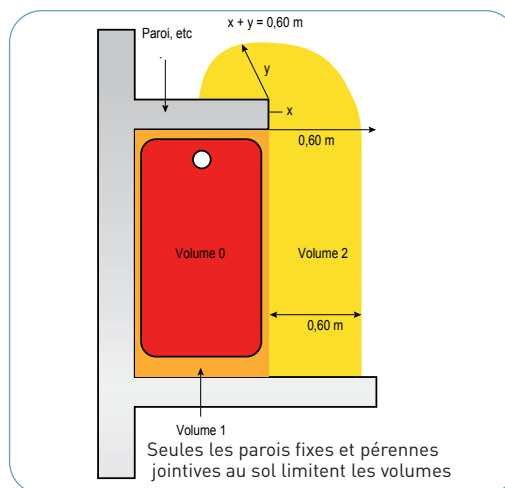
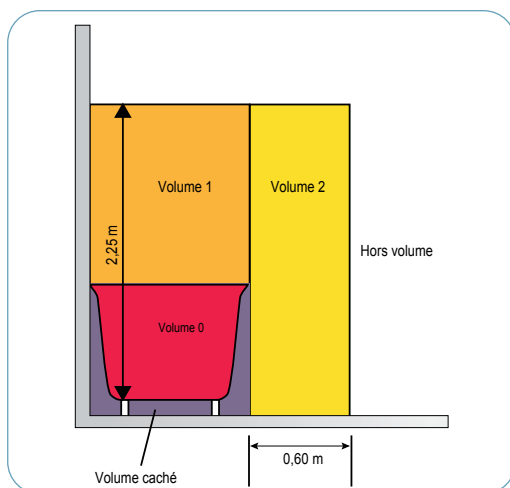

Volume Caché :
sous la baignoire
ou le receveur

Volume 0
volume de la baignoire
ou de la douche avec
receveur et 10 cm
de hauteur pour
les douches sans
receveur.

Volume 1
au-dessus du volume
0 et jusqu'à 2,25 m
à partir du fond de
la baignoire ou de la
douche avec ou sans
receveur.

Volume 2
0,6 m autour du
volume 1 et jusqu'à
2,25 m à partir du fond
de la baignoire ou
de la douche avec ou
sans receveur

DOUCHE AVEC RECEVEUR ENCASTRÉ

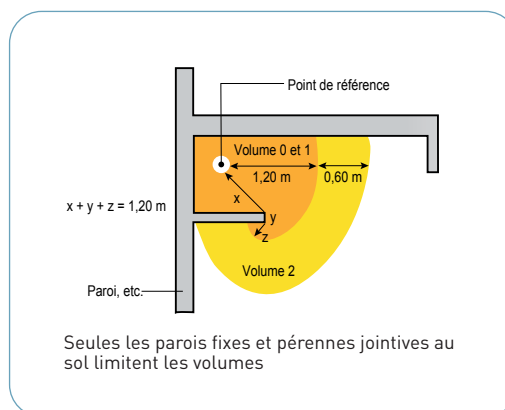
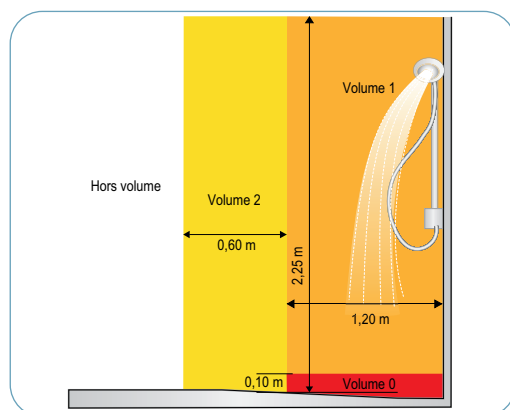

	Volume caché	Volume 0	Volume 1	Volume 2
DEGRÉ DE PROTECTION	IPX4	IPX7	IPX4	IPX4
Prise de courant (installation au sol interdite)	X	X	X	1 prise de courant alimenté par un transformateur de séparation pour rasoir (entre 20 et 50 VA) conforme NF EN 61558-2-5 autorisé
Appareils de chauffage	X	X	X	autorisé si classe 2 double isolation non relié à la terre
Luminaires	X	X*	X*	autorisé si classe 2 double isolation non relié à la terre
Interrupteurs (hauteur 0,90 ≤ 1,30m)	X	X	X*	X*
Chauffe-eau 230V - à accumulation (À condition que le circuit d'alimentation soit protégé par DDR 30 mA)	X	X	Si type horizontal l'installer le plus haut possible	Autorisé si impossible de le placer hors volume. Alimenté directement par un câble sans boîte de connexion
- instantané	X	X	Autorisé si impossible de le placer hors volume. Alimenté directement par un câble sans boîte de connexion	
Lave-linge Sèche-linge	X	X	X	X
Élément électrique chauffant (Noyé dans le sol)	X	X	X	Autorisé si recouvert d'un grillage métallique (ou comportant un revêtement métal) mis à la terre et relié à la liaison équipotentielle

X Interdit Autorisé sous conditions

* Interdit sauf TBTS 12V avec transformateur de séparation installé hors volume 1 ou 2

LIAISON ÉQUIPOTENTIELLE SUPPLÉMENTAIRE (LES)

La norme recommande 3 solutions pour la réalisation de la liaison équipotentielle supplémentaire :

- Raccordement direct au niveau d'un même tableau de distribution/répartition [solution limitée aux locaux d'habitation au sens de la norme, le tableau étant jugé dans ce cas suffisamment proche]
- Raccordement au niveau d'une boîte de connexion spécifique à l'ensemble des circuits concernés par le local, implantés à l'extérieur de celui-ci ou dans un local adjacent sur une paroi commune. Cette boîte contient un bornier de raccordement.
- Une solution mixte combinant les 2 solutions ci-dessus

NORMES ET DISTANCES DE SÉCURITÉ POUR PERSONNES À MOBILITÉ RÉDUITE

CONCEPTION D'UNE SALLE DE BAINS

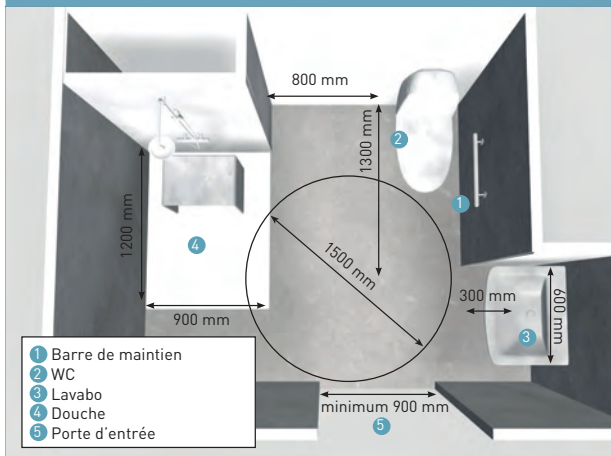

- 1 Barre de maintien
- 2 WC
- 3 Lavabo
- 4 Douche
- 5 Porte d'entrée

- Un espace de manœuvre d'un **diamètre de 1500 mm** est nécessaire pour la bonne circulation d'un fauteuil.
- Un espace d'usage permet le positionnement d'un fauteuil roulant, à l'aplomb de l'équipement à utiliser.
- Il doit correspondre à un **rectangle de 800 mm x 1300 mm** hors encombrement de tout obstacle.

POINT D'EAU

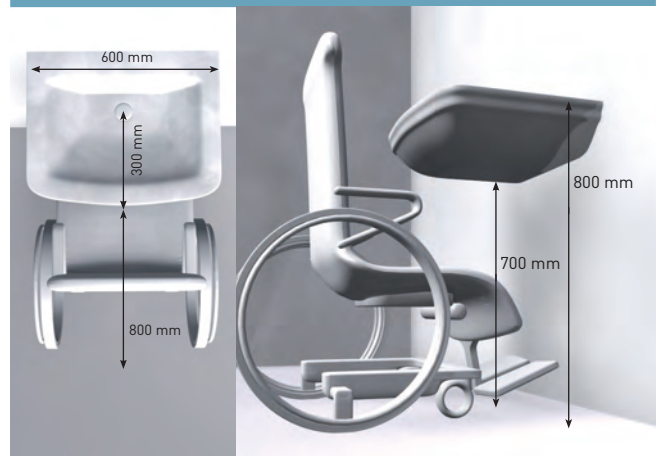

- L'espace libre sous le lavabo doit se situer à **700 mm du sol**.
- Le point supérieur de ce plan doit se situer à **800 mm du sol**.
- Les vasques ou lavabos choisis doivent présenter un espace vide en partie inférieure de **300 mm de profondeur et 600 mm de largeur**.
- L'espace de rapprochement frontal du fauteuil doit être de **800 mm minimum du bord antérieur du lavabo**.

DOUCHE

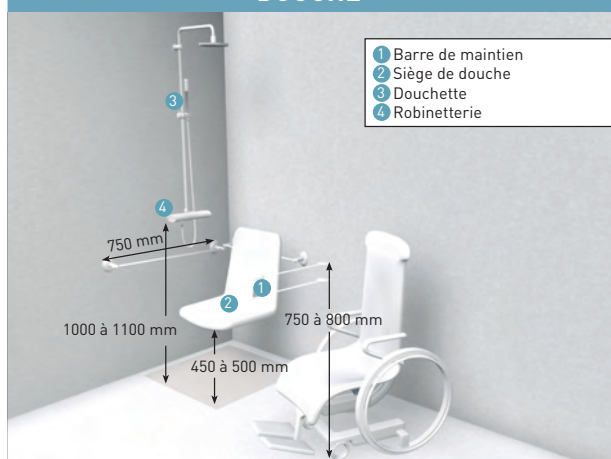

- 1 Barre de maintien
- 2 Siège de douche
- 3 Douchette
- 4 Robinetterie

- La douche doit comporter :
 - Un siège de douche relevable ou suspendu dont la surface d'assise est située entre **450 mm et 500 mm du sol**.
 - Une barre d'appui avec remontée verticale à **750 mm** de la robinetterie et entre **750 mm et 800 mm du sol**.
 - Un espace d'usage de **900 mm x 1200 mm** situé latéralement à ces équipements
 - Des accessoires accessibles en position assise
 - Un **mitigeur de douche fixé entre 1000 et 1100 mm du sol** équipé d'un système anti-brûlure.

ESPACE TOILETTES

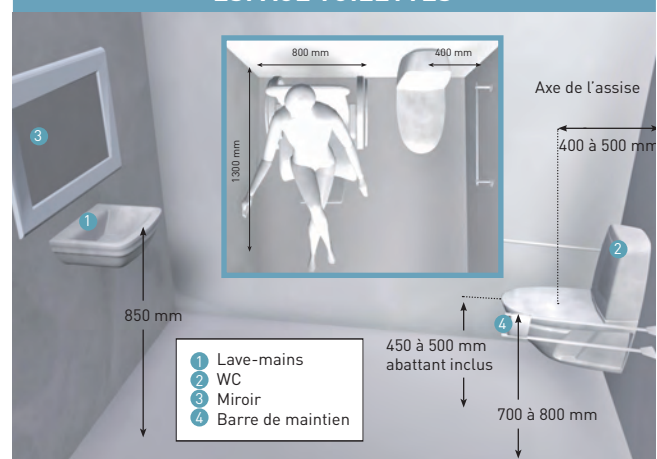

- 1 Lave-mains
- 2 WC
- 3 Miroir
- 4 Barre de maintien

- Le **cabinet d'aisances aménagé** est obligatoire en ERP. Il doit comporter :
 - Un espace de manœuvre de **1500 mm** de diamètre
 - Un lave-mains dont le plan supérieur est positionné à **850 mm de hauteur**
 - Une cuvette avec abattant dont l'assise est située entre **450 et 500 mm du sol**
 - Une barre d'appui positionnée entre **700 et 800 mm de hauteur**.
- Dans un **WC indépendant** du cabinet d'aisances, un espace d'usage de **800 mm x 1300 mm**, à côté des toilettes est obligatoire ainsi qu'une barre d'appui relevable fixée entre **700 et 800 mm de hauteur**.

PRODUITS ET ACCESSOIRES INDISPENSABLES POUR PERSONNES À MOBILITÉ RÉDUITE



POINT D'EAU

- Lavabo suspendu avec siphon déporté
- Lavabo ou meuble à hauteur variable

DOUCHE

Elle doit être facilement accessible

- **Le receveur :**
 - à l'italienne de plain-pied
 - extra plat
 - à encastrer à fleur de solLe receveur doit être antidérapant et respecter à minima la **Norme PN18**
- **La paroi de douche** devra permettre une accessibilité totale
 - soit simple paroi à grande ouverture
 - soit double parois battantes et idéalement une ouverture à mi-hauteur pour faciliter l'intervention d'une tierce personne

BAIN

Il existe des produits 2 en 1 : **la baignoire à porte**. La marche à franchir doit être inférieure à 18 cm.

ROBINETTERIE

- Électronique
- À commande déportée (fémorale)
- Équipée d'une manette rallongée
- Équipée d'une sécurité anti-brûlure Douche

ACCESSOIRES

- Barre relevable pour douche et WC
- Barre de redressement pour douche
- Siège pour douche
- Siège pour baignoire
- Barre de redressement pour lavabo
- Miroir inclinable
- Ainsi que tous les accessoires de salle de bains facilement accessibles

WC

- Pack WC équipé d'une cuvette surélevée
- Bâti-support équipé d'une cuvette rallongée idéalement réglable en hauteur.

NORMES EUROPÉENNES DE CARRELAGE

NORMES DE RÉSISTANCE

LE CLASSEMENT PEI

mesure la résistance à l'abrasion des carreaux émaillés et se compose de 5 groupes

- I** : Passage très faible
- II** : Passage faible
- III** : Passage fréquent
- IV** : Passage important
- V** : Passage intensif

LE CLASSEMENT UPEC

est un réel classement de durabilité et se compose de plusieurs niveaux auxquels sont attribués des indices de résistance :

- U** : Usure à la marche > coefficient de 1 à 4
- P** : Poinçonnement (usure due au mobilier) > coefficient de 1 à 4
- E** : Tenue à l'eau et à l'humidité > coefficient de 0 à 3
- C** : Tenue aux agents chimiques et produits tachants > coefficient de 0 à 3

RECOMMANDATIONS

LIEUX	PEI	UPEC
Pièce à vivre (salon, hall...)	PEI III	U2S P2 E1 C0
Chambre	PEI II	U2 P2 E1 C0
Cuisine	PEI IV	U3 P2 E2 C2
Salle de Bains*	PEI II	U2 P2 E3 C1
Balcon / terrasse	PEI IV	U3 P3 E3 C2
Entrée d'immeuble	PEI V	U4 P2 E2 C0

*pour la faïence (pose sur mur) on peut choisir un classement en PEI I

NORMES DE RÉSISTANCE AU GLISSEMENT

LE CLASSEMENT A/B/C est utilisé dans le cadre d'une utilisation en zone humide pieds nus

CLASSE	ANGLE D'INCLINAISON	PROJECTION	EXEMPLE D'APPLICATION
A	>12° adhérence moyenne		Salle de bains, toilettes
B	>18° adhérence élevée		Bacs à douche
C	>24° adhérence forte		Bord de bassin incliné, pédiluves

LE CLASSEMENT R9 à R13 correspond à une utilisation pieds chaussés

CLASSE	ANGLE D'INCLINAISON	PROJECTION	EXEMPLE D'APPLICATION
R9	3° - 12° adhérence normale		Bureaux, couloirs, escaliers
R10	10°-19° adhérence moyenne		Buanderies, garages, parkings, sanitaires, toilettes
R11	19°-27° adhérence élevée		Blanchisseries, chambres froides
R12	27°-35° adhérence forte		Réception et stockage industriel
R13	>35° adhérence forte		Conserveries, cuisines industrielles

CAPACITÉ CHAUFFE-EAU

NOMBRE D'HABITANTS	CAPACITÉ CEE TRADITIONNEL	CAPACITÉ CEE GAIN DE PLACE
1 adulte	50 L	40 L
1 adulte + 1 enfant	75 L	65 L
2 adultes	100 L	65 L
2 adultes + 1 enfant	150 L	80 L
2 adultes + 2 enfants	200 L	100 L
2 adultes + 3 enfants	250 L	120 L

EAU FROIDE

DÉTERMINATION D'UNE POMPE

EN PREMIER LIEU, DÉTERMINER LA CONSOMMATION JOURNALIÈRE POUR DÉFINIR LE **DÉBIT** :

- Nombre de personnes × 200 litres
 - 8 litres par mètre carré de gazon
 - 6 litres par mètre carré de jardin
- Additionner le tout (le total donnera la consommation/jour).

$$\text{DÉBIT} = \frac{\text{consommation/jour exprimé en m}^3/\text{h}}{3}$$

Rajouter 15 % pour plus de sécurité

DÉTERMINER ENSUITE LA **PRESSION** :

POMPE DE SURFACE Additionner :	POMPE IMMERGÉE Additionner :
Hauteur d'aspiration (en mètres) ▲ Maximum 8 mètres, au-delà, passer en pompe immergée.	Hauteur de refoulement jusqu'au point le plus haut (en mètres)
+ Hauteur de refoulement jusqu'au point le plus haut (en mètres)	+ Pression voulue pour l'utilisation (généralement 2,5 bars minimum, soit 25 mètres)
+ Pression voulue pour l'utilisation (généralement 2,5 bars minimum, soit 25 mètres)	
+ 15 % pour les pertes de charges (frottements, coudes...)	+ 15 % pour les pertes de charges (frottements, coudes...)
Donnent la pression que doit produire la pompe	Donnent la pression que doit produire la pompe

MAINTENANT QUE VOUS AVEZ CHOISI LE BON TYPE DE POMPE :

Pompe de surface ou pompe immergée, il va falloir déterminer quel modèle choisir en regardant les courbes de fonctionnement des pompes.

- L'axe horizontal représente le débit (exprimé en m³/h ou en l/h)
- L'axe vertical représente la hauteur manométrique (exprimé en mètre)

Le meilleur rendement d'une pompe se situe en milieu de courbe.

DÉTERMINATION D'UN ADOUCISSEUR

CHOISIR L'ADOUCCISSEUR ADAPTÉ À VOS BESOINS

NB DE PERSONNES PAR HABITATION	DURETÉ DE L'EAU °TH									
	15-20	20-25	25-30	30-35	35-40	40-45	45-50	50-55	55-60	
1										
2										
3										
4										
5										
6										
7										
8										
9										
10										

Quantité de résines nécessaires



SCHEMA D'INSTALLATION D'UN ADOUCISSEUR

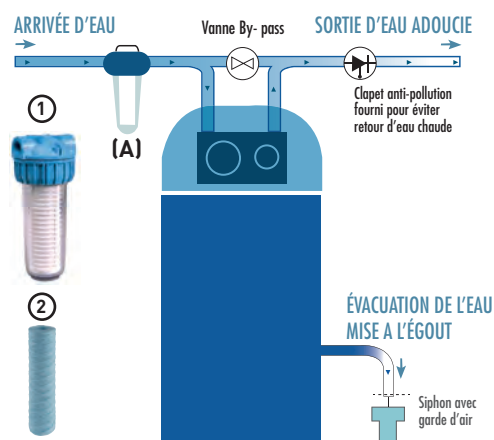

Prévoir OBLIGATOIREMENT en amont de l'adoucisseur (A) :

- Un filtre à eau ①
- Une cartouche de filtration 20 microns ②

Vérifiez que l'installation est munie d'un réducteur de pression et d'un clapet type EA.

CHAUFFAGE

CONCEPTION D'UNE INSTALLATION DE CHAUFFAGE AVEC CHAUDIÈRE DÉTAIL DES ÉQUIPEMENT PRINCIPAUX*

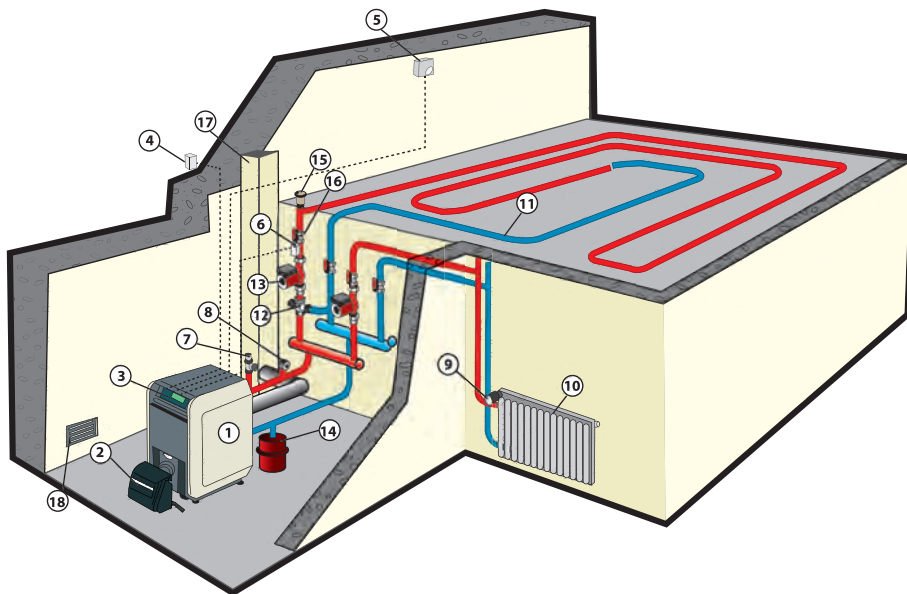

- ① Chaudière
- ② Brûleur
- ③ Régulateur
- ④ Sonde extérieure
- ⑤ Commande à distance
- ⑥ Sonde de départ après vanne
- ⑦ Soupape de sécurité
- ⑧ Manomètre
- ⑨ Robinet thermostatique
- ⑩ Radiateur
- ⑪ Plancher chauffant
- ⑫ Vanne mélangeuse
- ⑬ Circulateur
- ⑭ Vase d'expansion
- ⑮ Purgeur automatique
- ⑯ Vanne d'isolement
- ⑰ Cheminée
- ⑱ Aération de la chaufferie

* il existe aussi en solution PAC

DÉTERMINATION D'UN CIRCULATEUR

LE DÉBIT DÉPEND :

- de la puissance de la chaudière, (P en kiloWatts)
- de la différence (ΔT) entre la température de « départ » de la chaudière et la température de « retour » à la chaudière. Cet écart est spécifique au type de corps de chauffe concerné. Pour le connaître, il faut consulter les tables de valeurs proposées par les fabricants de corps de chauffe. On peut retenir les valeurs moyennes suivantes :
- radiateurs : 15/20°C, planchers chauffants : 10 °C.

$$Q \text{ (m}^3\text{/h)} = \frac{P \text{ (kW)}}{\Delta T \text{ (}^\circ\text{C)} \times 1,163}$$

ATTENTION : il faut prendre en compte la puissance de la chaudière consacrée au chauffage (et pas la puissance totale s'il y a aussi production d'ECS) !

LA PRESSION :

Dans un circuit fermé, la Hauteur Manométrique Totale est égale aux pertes de charge.

On considère (loi de Flamand), que la **HMT** moyenne d'un circuit réalisé dans les règles de l'art est d'environ 20 mm/mètre linéaire de tuyauterie.

Comme pour l'eau froide, maintenant que vous avez choisi le bon type de circulateur, il va falloir déterminer quel modèle choisir en regardant les courbes de fonctionnement des circulateurs.

- L'axe horizontal représente le débit (exprimé en m³/h ou en l/h)
- L'axe vertical représente la hauteur manométrique (exprimé en mètre)

Le meilleur rendement d'une pompe se situe en milieu de courbe.

CONCEPTION D'UNE INSTALLATION DE POMPE À CHALEUR EN RELÈVE DE CHAUDIÈRE POUR L'INSTALLATION D'UNE POMPE À CHALEUR EN RELÈVE DE CHAUDIÈRE LES DIFFÉRENTS ÉQUIPEMENTS ET LEUR EMPLACEMENT SONT INSTALLÉS SELON LE SCHEMA PRÉSENTÉ :

- ① Chaudière
- ② Ballon tampon
- ③ Dégazeur
- ④ Soupape différentielle
- ⑤ Échangeur et PAC
- ⑥ Filtration et décantation
- ⑦ Contrôle du débit
- ⑧ Résistance électrique d'appoint
- ⑨ Vanne mélangeuse
- ⑩ Circulateur
- ⑪ Aquastat de sécurité
- ⑫ Pot de décantation
- ⑬ Sécurité pression
- ⑭ Variante de filtre + décantation

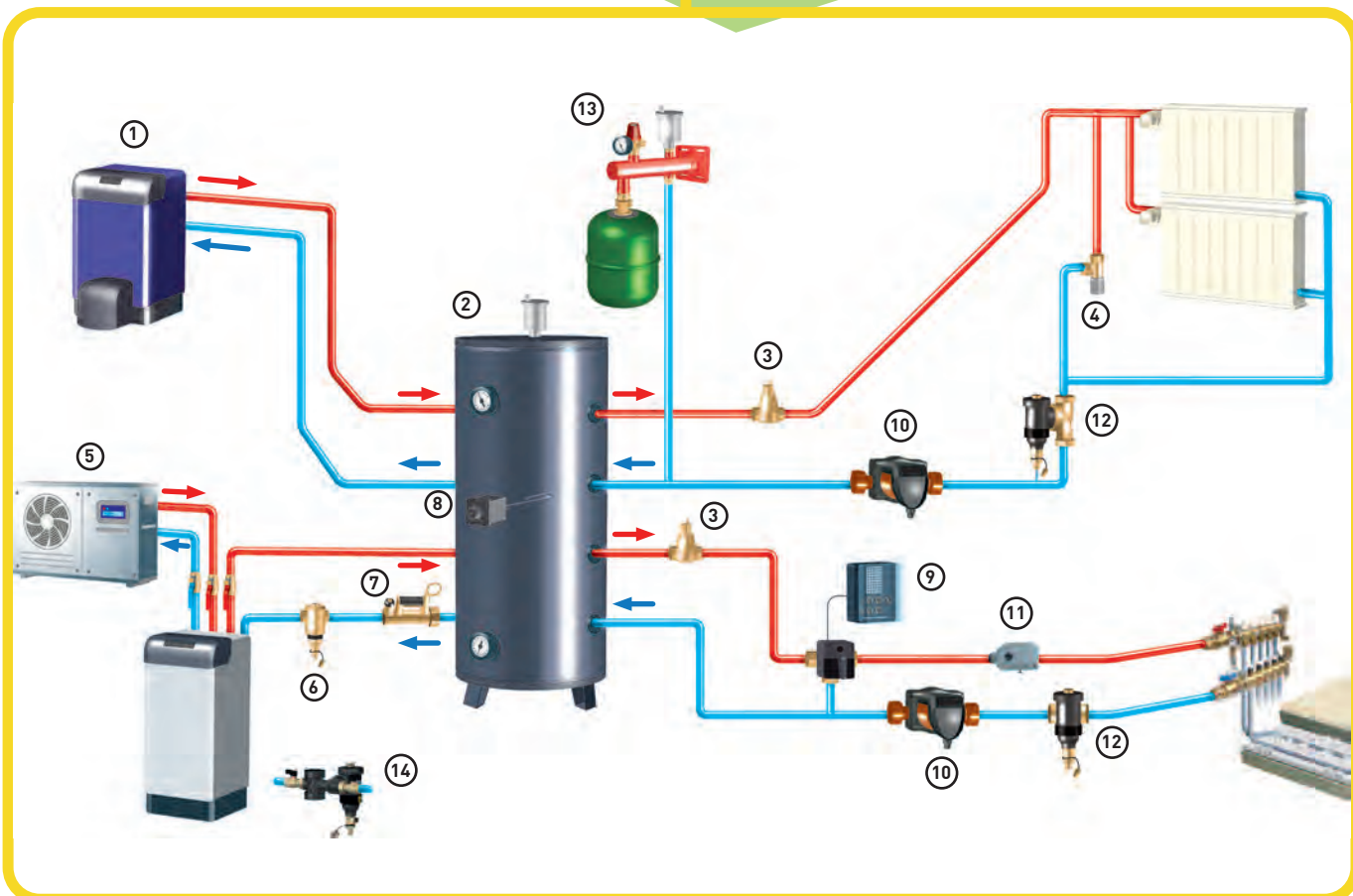
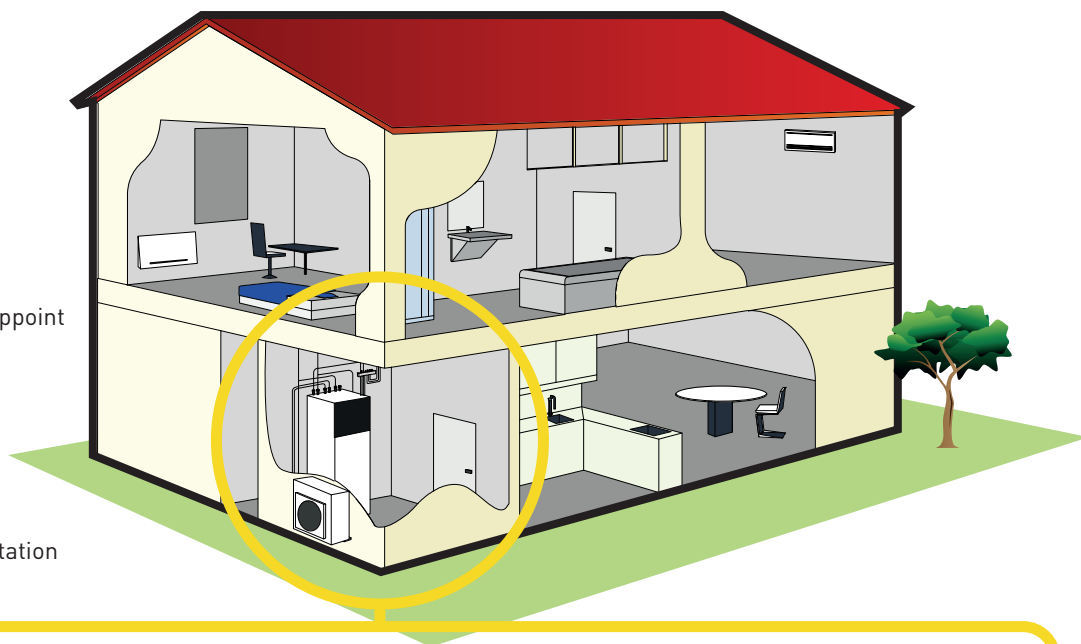

Les informations techniques de ce document ne sont que des montages types et donc non exhaustifs. Chaque installation demande une étude personnalisée.

VENTOUSE

DÉTERMINATION D'UNE VENTOUSE GAZ

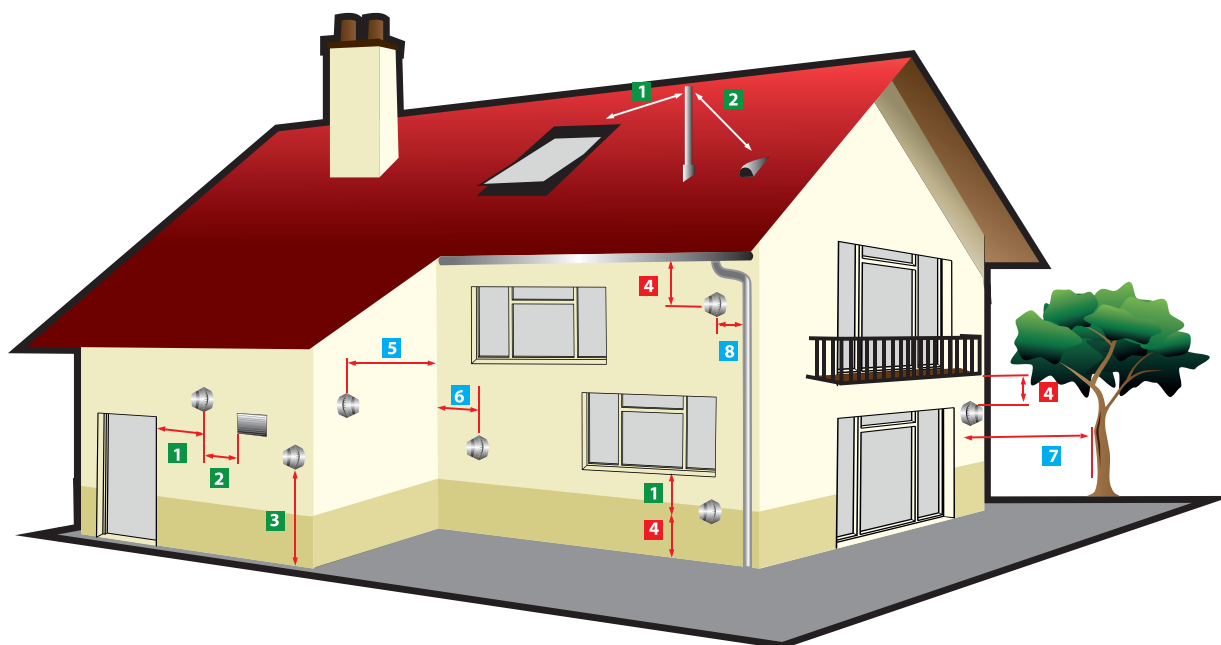

À RESPECTER IMPÉRATIVEMENT

Pour les appareils étanches (ventouse), il convient de respecter les prescriptions de l'arrêté du 27 avril 2009, modifiant l'arrêté du 2 août 1977, du DTU 61.1 P4 (P 45-204-4) d'août 2006 et, pour les mini-chaufferies, le cahier des charges ATG C.321.4. Ces textes précisent notamment les conditions d'implantation du débouché de la ventouse. Celui-ci doit être situé à 0,40 m au moins de toute ouverture et à 0,60 m de tout orifice d'entrée d'air de ventilation. Ces deux distances s'entendent de l'axe de l'orifice d'évacuation des gaz brûlés au point le plus proche de l'ouverture ou de l'orifice de ventilation.

- 1** 0,40 m - Distance minimale entre l'axe du conduit d'évacuation des fumées et une ouverture.
- 2** 0,60 m - Distance minimale entre l'axe du conduit d'évacuation des fumées et un orifice de ventilation.
- 3** 1,80m - Les ventouses débouchant à moins de 1,80 m du sol doivent être équipées d'une protection mécanique. Les ventouses débouchant directement sur une voie publique ou privée et situées à moins de 1,80 m du sol (**à l'exception des chaudières à condensation**) doivent comporter un déflecteur orientant les gaz des fumées dans une direction sensiblement parallèle au mur.
- 4** Débouché sous une surface horizontale ou sous débords de toiture. Le débouché du terminal horizontal doit s'effectuer au nez extérieur de ce surplomb dans l'un des cas suivants :
 - La distance d'un terminal horizontal par rapport à la surface horizontale située au-dessus est inférieure à 0,30 m.
 - La largeur de la surface horizontale surplombant le débouché est supérieure à 2 m.
 - Présence d'une retombée en sous-face de la surface horizontale de plus de 0,2 m

Le débouché peut ne pas s'effectuer au nez extérieur et dans le cas des surplombs supérieurs à 2 m, si la distance verticale entre le débouché du terminal et le surplomb est supérieure à la largeur du surplomb.

- 4** Débouché en toiture ou au-dessus d'une surface horizontale : Le débouché en toiture d'un terminal horizontal par rapport à une toiture ou une surface horizontale située en dessous est au moins égal à 30 cm. Cette distance est mesurée en projection verticale entre le centre du terminal et le point le plus près de la toiture ou du sol.
- 5** 1,50 m - Distance minimale entre l'axe du conduit d'évacuation des fumées et un mur à 90° comportant une fenêtre ou un orifice de ventilation
- 6** 0,15 m - Distance minimale entre l'axe du conduit d'évacuation des fumées et un mur à 90° sans ouverture
- 7** 2,00 m - Distance minimale entre l'axe du conduit d'évacuation des fumées et une plantation
- 8** 0,10 m - Distance minimale entre l'axe du conduit d'évacuation des fumées et une tuyauterie verticale

Lors de la traversée de paroi, il faut prévoir la mise en place d'un fourreau lorsqu'il existe un risque de corrosion du conduit, l'espace annulaire entre le fourreau et le conduit devant être obturé par une matière inerte.

Les conduits éventuellement placés en dehors du local où est installé l'appareil doivent respecter les prescriptions suivantes :

- À l'intérieur des logements ou de ses dépendances, les conduits doivent être protégés contre les chocs mécaniques
- Dans la traversée des autres logements ou des parties communes, les conduits doivent être d'allure verticale et placés à l'intérieur d'une gaine de degré coupe-feu conforme à la réglementation contre l'incendie et de degré.

CONDUIT DE FUMÉE

SCHÉMAS DE PRINCIPE

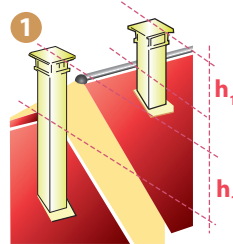
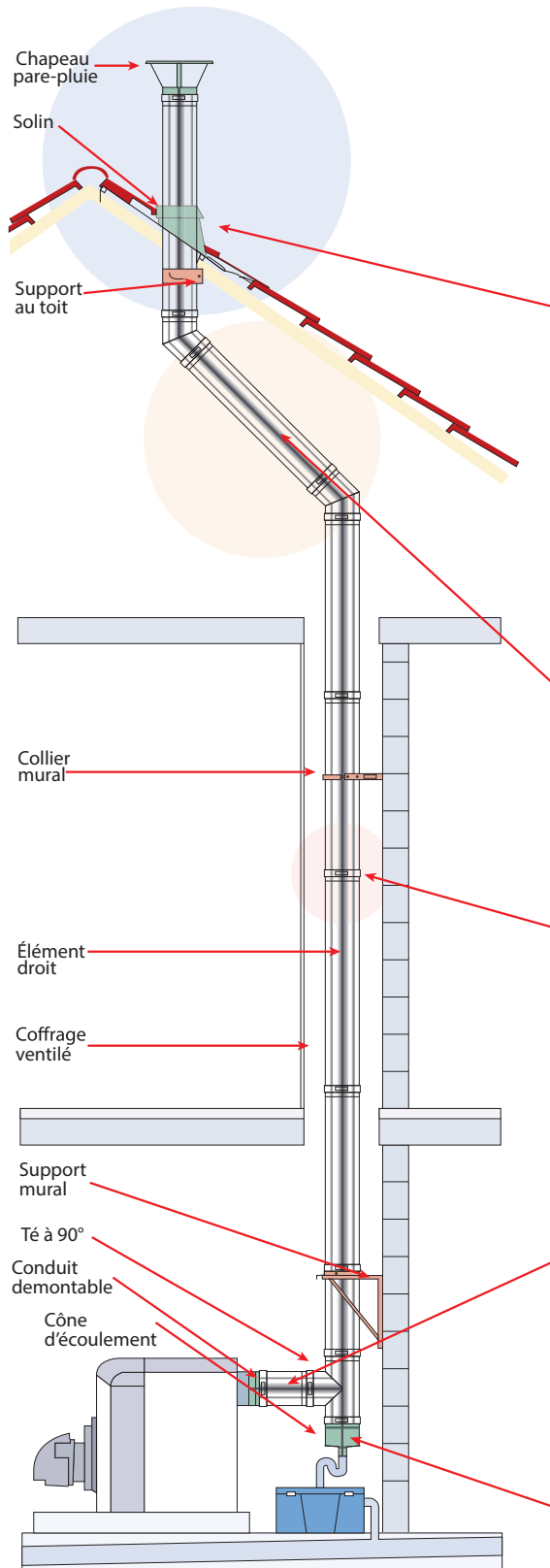

Les règles en toiture

Texte de référence: DTU 24.1 (5.4.7 et 5.4.8.) et NF EN 15287 (ANNEXE M)

$$h_1 = 40 \text{ cm}$$

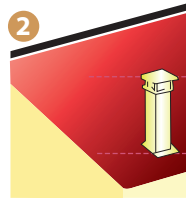

2

$$h_2 = 120 \text{ cm}$$

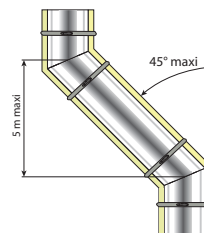

Le tracé du conduit de fumée

Texte de référence: DTU 24.1 (5.4)

2 changements de direction sont autorisés.

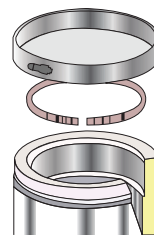

L'assemblage du conduit

Texte de référence: DTU 24.1 (13)

Respecter le sens des fumées.

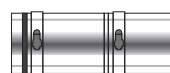

Le conduit de raccordement

Texte de référence: DTU 24.1 (13)

Le plus court possible (< à 3 ml).

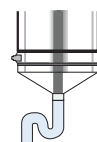

Le bas du conduit

CONDUIT DE FUMÉE

ABAQUES DE DIMENSIONNEMENT

CONDUIT MAÇONNÉ TUBÉ

CHAUDIÈRE FIOUL BASSE TEMPÉRATURE
AVEC TFUMÉE $\geq 120^{\circ}\text{C}$
DIAMÈTRE NOMINAL INFÉRIEUR OU ÉGAL À 139

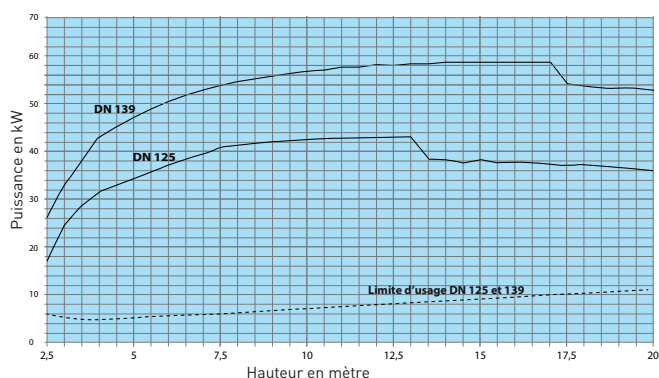

CHAUDIÈRE FIOUL À CONDENSATION
AVEC TFUMÉE $\geq 80^{\circ}\text{C}$

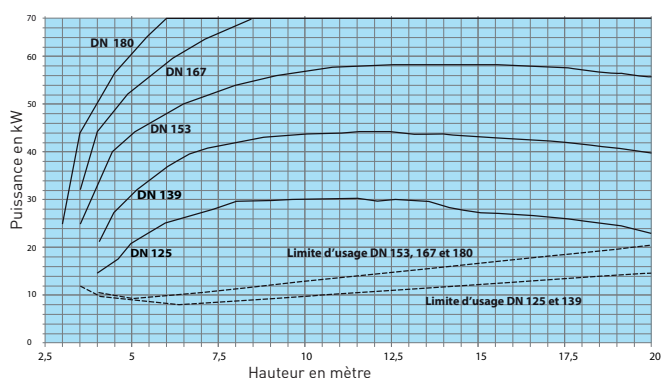

Tablage selon les règles en vigueur : ventilation basse 20 cm² et ventilation haute 5 cm².

CONDUIT MÉTALLIQUE ISOLÉ R $\geq 0,4 \text{ M}^2 \cdot \text{K/W}$

CHAUDIÈRE FIOUL BASSE TEMPÉRATURE
AVEC TFUMÉE $\geq 120^{\circ}\text{C}$

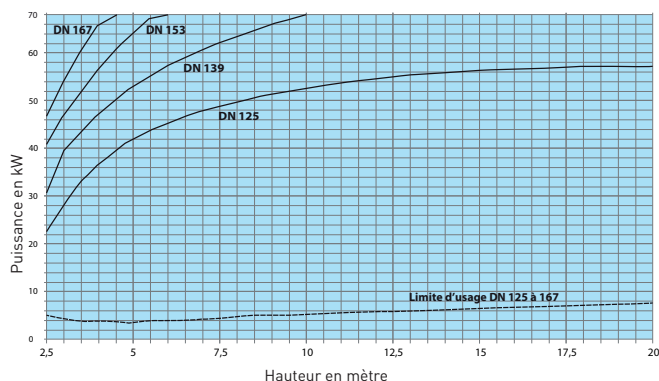

CHAUDIÈRE FIOUL À CONDENSATION
AVEC TFUMÉE $\geq 80^{\circ}\text{C}$

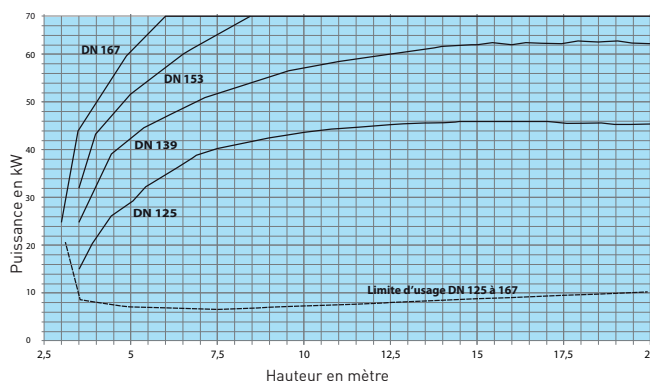

GAZ NATUREL

MONTAGE TYPE D'INSTALLATIONS AU GAZ NATUREL BRANCHEMENT D'HABITATION INDIVIDUELLE

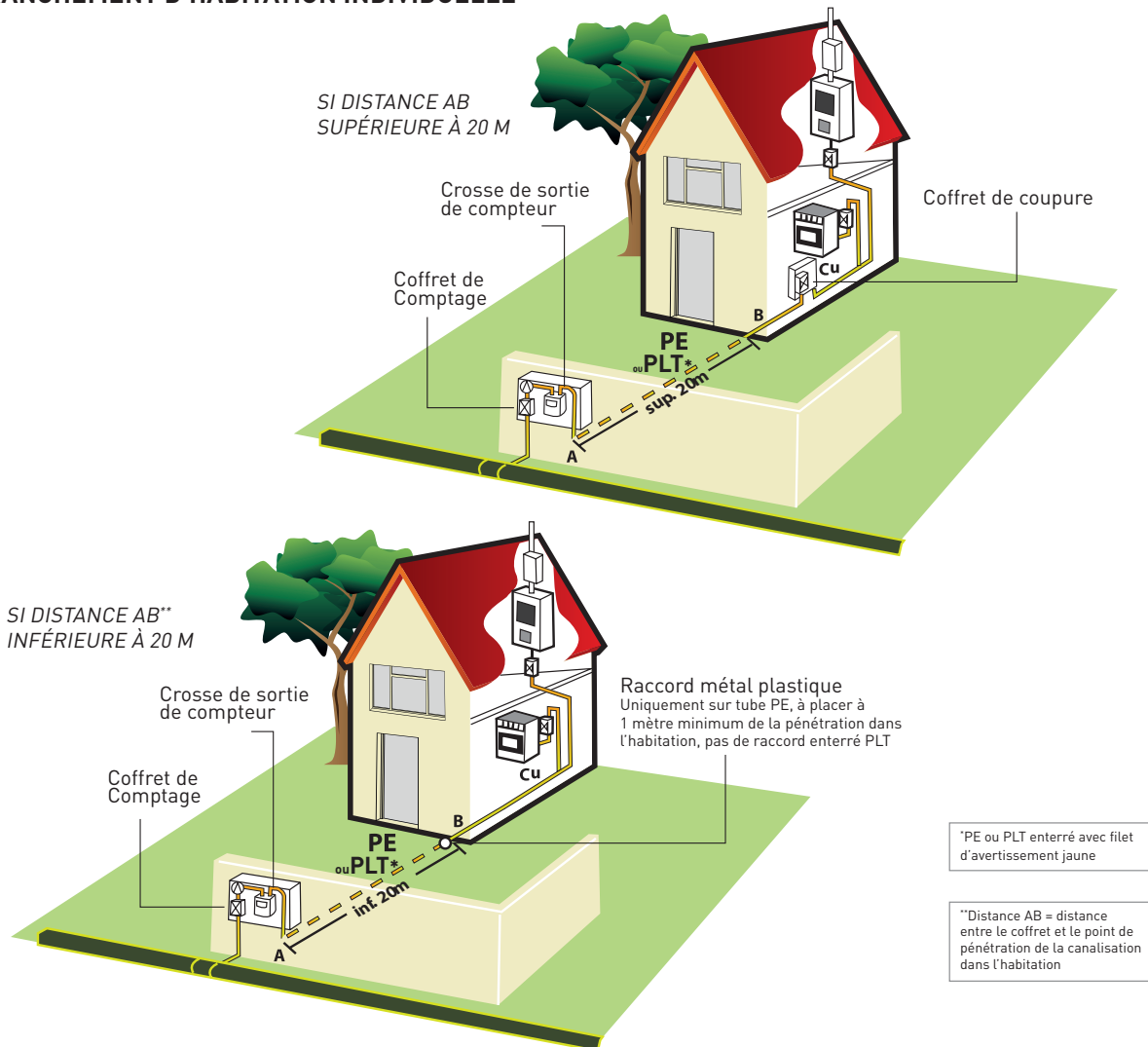

RACCORDEMENT D'APPAREIL DE CUISSON

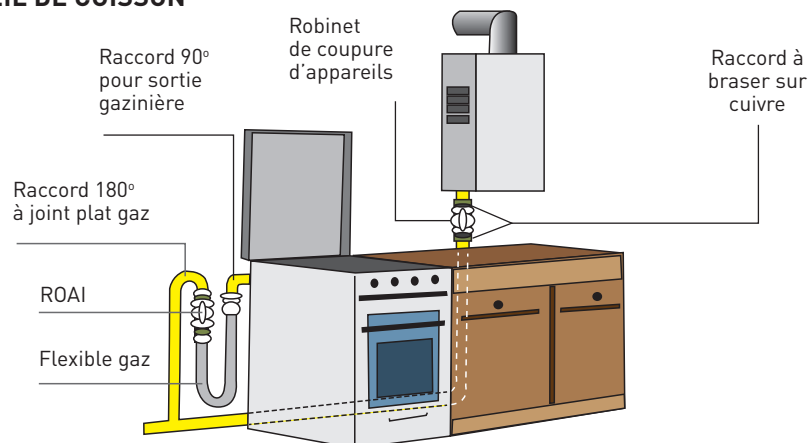

Les informations techniques de ce document ne sont que des montages types et donc non exhaustifs. Chaque installation demande une étude personnalisée.

GAZ BUTANE OU PROPANE

MONTAGE TYPE D'INSTALLATIONS AU GAZ BUTANE HABITATION ALIMENTÉE PAR BOUTEILLE

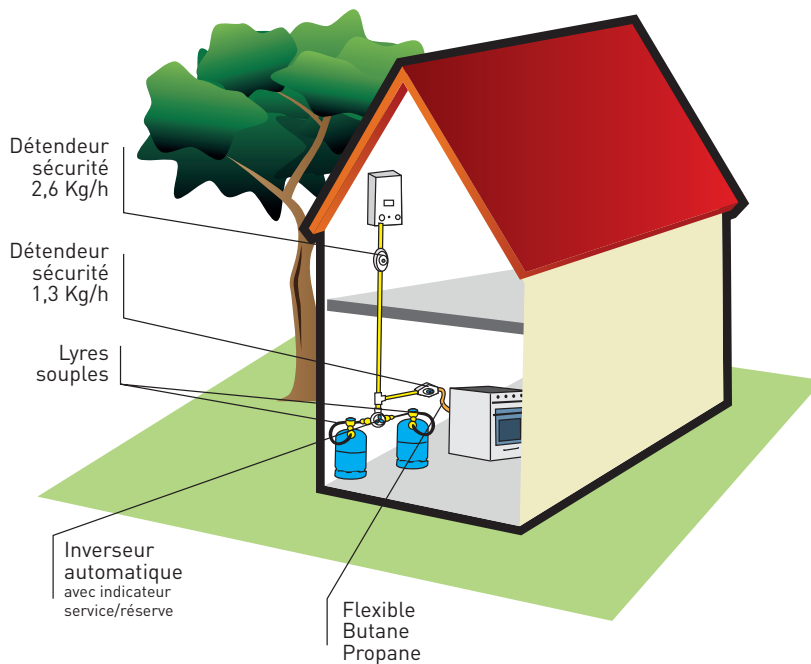

CUISINIÈRE AVEC BOUTEILLE ET INVERSEUR MANUEL

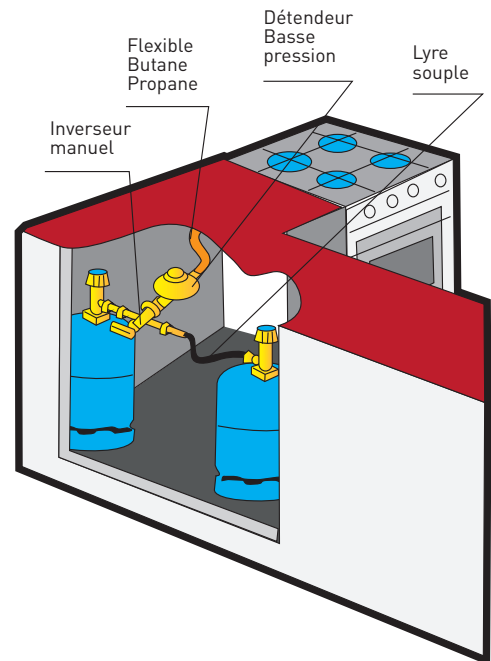

MONTAGE TYPE D'INSTALLATIONS AU GAZ PROPANE HABITATION ALIMENTÉE PAR CITERNE INDIVIDUELLE

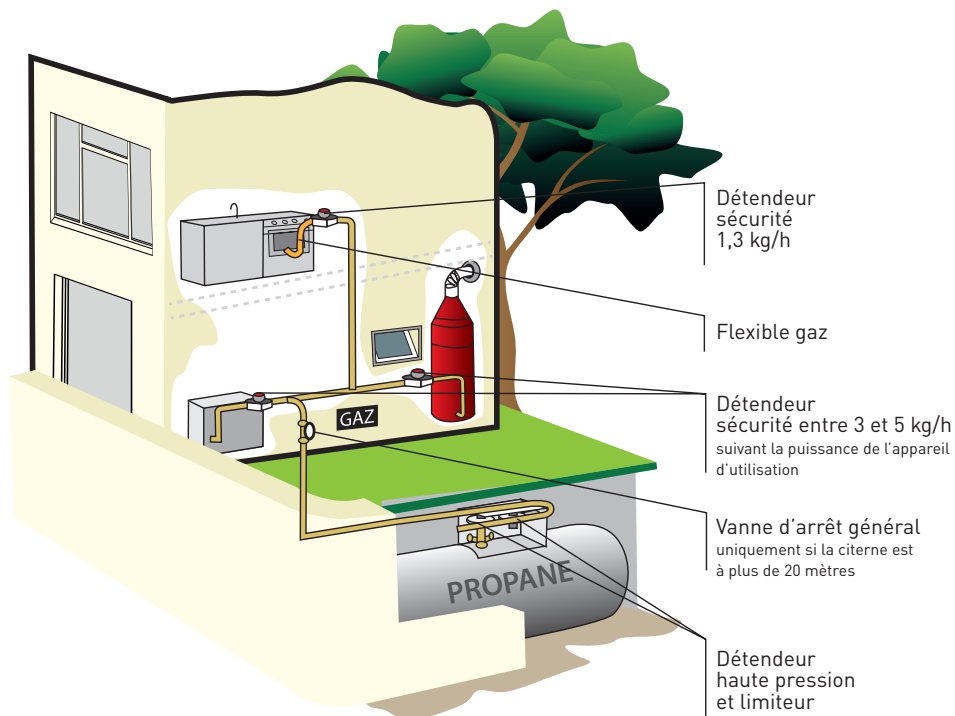

Les informations techniques de ce document ne sont que des montages types et donc non exhaustifs. Chaque installation demande une étude personnalisée.

NORME F-GAS



Le règlement européen F-Gas N° 517/2014 vise à améliorer la traçabilité des fluides frigorigènes. Il est entré en vigueur depuis le 1^{er} janvier 2015 et a été complété par l'arrêté du 29 février 2016.

POURQUOI UNE TELLE RÉGLEMENTATION ?

Les fluides frigorigènes utilisés dans les équipements de climatisation/ réfrigération ou pompes à chaleur sont de puissants gaz qui ont des effets sur la couche d'ozone.

Le nouveau règlement prévoit **la réduction par 5 des HFC** (Hydrofluorocarbures).

Cela se traduit par :

- Des quotas fixant le **rythme de décroissance de ces gaz** jusqu'à l'horizon 2030
- L'arrivée sur le marché de **nouveaux fluides moins polluants**.

QUELLES OBLIGATIONS POUR LES FABRICANTS ET LES DISTRIBUTEURS ?

Les fabricants mettant sur le marché des appareils contenant des gaz HFC doivent être déclarés auprès des autorités européennes afin de permettre une **traçabilité des quotas** en tonnes équivalent CO₂.

En tant que distributeur nous sommes dans l'obligation de nous assurer que l'acheteur de fluides ou d'appareil contenant des fluides frigorigènes est en **possession d'une attestation de capacité (AdC)** ou a souscrit un **contrat d'assemblage** et de mise en service (type **CERFA 15498*02**) auprès d'un opérateur certifié par son AdC. Toujours dans un souci de traçabilité des fluides, nous sommes dans l'obligation de tenir un registre des ventes à jour avec les AdC et contrats d'assemblage y afférant pour une transmission à l'ADEME.



QUELLES SANCTIONS ?

En cas de vente de fluides en emballages jetables, de non reprise de fluides usagés pour retraitement, de non contrôle de fuite (détendeur d'équipement), de non respect des règles de confinement ou encore toute opération de dégazage pourra entraîner pour chaque infraction une amende de classe 5 (1 500 € doublée en cas de récidive). La cession de fluide à un opérateur n'ayant pas d'AdC ou la non transmission des déclarations annuelles à l'ADEME entraîne une contravention de 3^{ème} classe (450 €) par infraction.

NORME F-GAS

QUI PEUT MANIPULER LES FLUIDES FRIGORIGÈNES ?

En tant qu'installateur vous devez impérativement :

- être en possession d'une attestation de capacité (AdC) en cours de validité
- ou apporter la preuve que vous avez contractualisé un contrat d'assemblage avec un opérateur détenant l'AdC pour le raccordement et la mise en service de l'appareil. Le contrat devra contenir les coordonnées de l'acquéreur, de l'installateur agréé, du type d'équipement et de la famille de fluide contenu dans les appareils ainsi que la signature des deux parties.

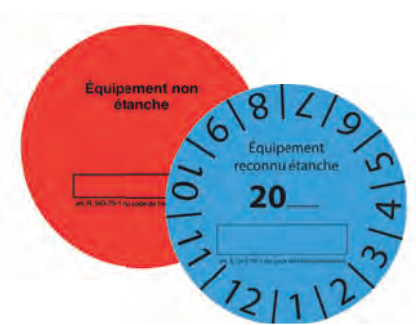

Société :	Tél :
Adresse :	Fax :
Date de mise en service :	
Type d'installation :	Identification :
Régime de fonctionnement :	
T Evap : (°C)	P Evap : (bar)
T Cond : (°C)	P Cond : (bar)
Fluide : l'équipement contient des gaz à effet de serre fluorés (voir réglementation) Nom chimique (ISO117)	
<input type="checkbox"/> HFC	<input type="checkbox"/> Fluides Naturels
<input type="checkbox"/> AAutres	
Charge (kg)	Tonnes équivalent CO ₂ (TeqCO ₂)
Huile :	Quantité (l)
<input type="checkbox"/> Minéral	<input type="checkbox"/> Alkylbenzène
<input type="checkbox"/> POE	<input type="checkbox"/> PVE
Nom :	

QUELLES SONT MES OBLIGATIONS LORS DE L'ENTRETIEN ET DE LA MISE EN SERVICE ?

- Lors de chaque intervention sur le circuit frigorifique ou lors de la manipulation de fluide **une fiche d'intervention de type Cerfa 15497*02** doit être dûment remplie et fournie entre autre au détenteur de l'équipement et au centre de retraitement des déchets.
- Après chaque contrôle d'étanchéité, si l'installation ne présente **aucune fuite, une vignette bleue** doit être apposée de façon visible avec un poinçon indiquant la date limite de validité du contrôle. Si **une fuite a été constatée, une étiquette rouge** viendra recouvrir l'ancienne pastille bleue jusqu'à remise en conformité. Chaque intervention doit être consignée dans le Cerfa 15497*02.
- Lors de la mise en service, une plaque de type identification devra également être apposée sur le matériel. Elle mentionnera qu'il contient des « gaz à effet de serre fluorés relevant du protocole de Kyoto », le nom chimique et sa quantité en kg CO₂.

COMMENT OBTENIR L'ATTESTATION DE CAPACITÉ ?

Vous pouvez faire former votre personnel afin d'obtenir l'attestation de capacité (AdC) à l'issue d'une formation à la manipulation des fluides frigorigènes délivrée par un organisme certificateur.

Nos partenaires proposent ces certifications dans différents centres de formations : contactez votre agence afin d'être mis en relation.



CE QU'IL FAUT SAVOIR SUR TRACKDÉCHETS

L'OUTIL TRACKDÉCHETS ? EST-IL OBLIGATOIRE ?



Trackdéchets est un outils numérique gratuit, développé par le Ministère de la Transition Écologique, sous un format innovant d'amélioration continue par la donnée et les usages.

Le décret 2021-321, issu de la loi Économie Circulaire, impose la dématérialisation de la traçabilité des déchets dangereux et/ou contenant des POP.

Les arrêtés ministériels du 21 décembre 2021 relatif à la traçabilité des déchets dangereux et des déchets d'amiante fixent les dispositions réglementaires pour l'usage de la plateforme et rendent obligatoire la traçabilité dématérialisée pour les déchets concernés (dangereux et amiante) depuis le 1^{er} janvier 2022.

EST-CE QUE JE PEUX L'UTILISER MÊME SI J'AI DÉJÀ UN OUTIL DE GESTION DES DÉCHETS ?

Oui, Trackdéchets est un outil de traçabilité et non un outil de gestion des déchets (pas de facturation, bon de commande, etc...) : ce sont des outils complémentaires.

Si vous avez un outil, vous pourrez le connecter à la plateforme grâce à l'API Trackdéchets. Pour en savoir plus consultez la documentation Développeur.

QUI EST CONCERNÉ PAR TRACKDÉCHETS ?

Tous les acteurs présents sur une chaîne de traçabilité sont concernés par Trackdéchets, car la mission de cette plateforme est notamment de garantir la circulation de l'information de traçabilité d'un bout à l'autre de la chaîne.

LES DIFFÉRENTS ACTEURS DE LA FILIÈRE



Les **Détenteurs** de déchets sont tous les intermédiaires de la chaîne d'élimination des déchets. Le détenteur de déchets peut tout aussi bien être le Producteur de déchets ou toute autre personne qui se trouve en possession des déchets (ex. : l'exploitant de l'installation de stockage intermédiaire, le transporteur de déchets).

Article L 541-1-1 du Code de l'environnement.



Le **Frigoriste** (attestation de capacité) qui collecte les déchets. Le Frigoriste qui transporte les bouteilles de récupération chez un distributeur doit également ajouter le profil transporteur afin de pouvoir être visé, et cochez la case « *Le transporteur déclare être exempté de récépissé conformément aux dispositions de l'article R.541-50 du code de l'environnement* ». Le Frigoriste peut transporter jusqu'à 100 Kg de déchets (fluide).



Le **Transporteur** est celui qui effectue la prise en charge et le transport effectif du déchet. Un Transporteur professionnel dispose d'un récépissé de transport de matière dangereuse. Il y a des exemptions et notamment lorsque la quantité de déchets est inférieure à 100 Kg (ici le fluide), ainsi l'opérateur peut transporter les déchets. Le bordereau est complété et signé dans ce sens. Lorsque l'Opérateur est l'Émetteur et le Transporteur, il va effectuer les 2 signatures du bordereau.



Le **Destinataire** est l'installation qui doit accueillir le déchet. Pour pouvoir accueillir le déchet, même de façon transitoire, le destinataire doit être déclaré dans TRACKDÉCHETS comme « *installation de Transit, regroupement ou tri de déchets* ».

CE QU'IL FAUT SAVOIR SUR TRACKDÉCHETS

GÉRER LA TRAÇABILITÉ DES DÉCHETS EN TOUTE SÉCURITÉ

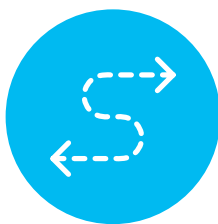
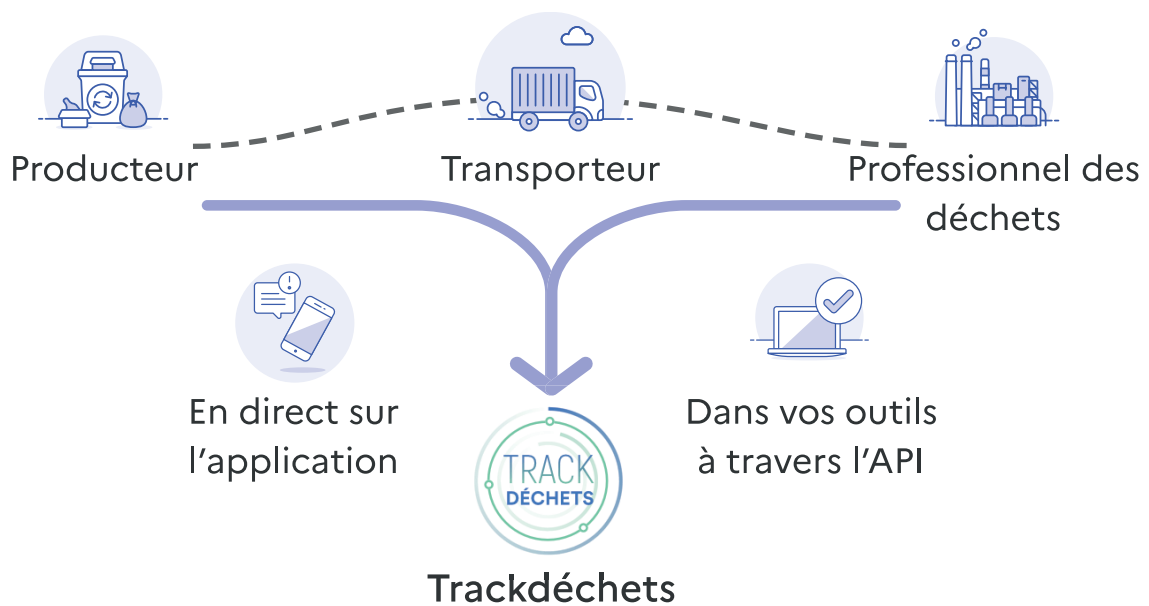

**SIMPLIFIER LA TRAÇABILITÉ DES
DÉCHETS EN TEMPS RÉEL**



**APPORTER DE LA TRANSPARENCE ET DE
LA FIABILITÉ DANS LA FILIÈRE DÉCHETS**

SYSTEMES MULTICOUCHE

PEXAL - MIXAL - BRAVOPRESS
PEXAL EASY - PEXAL BRASS - PEXAL XL



Les solutions les plus performantes pour l'alimentation

Une gamme complète de tubes et raccords pour la réalisation d'installations sanitaires, de chauffage haute et basse température, pour air comprimé et réseaux industriels. Flexibilité, extrême rapidité et facilité de mise en oeuvre. Largeur et profondeur de gamme (du diamètre 16 au 110). Gamme multi empreinte.

Suivez-nous sur:



www.valsir.fr

MADE IN ITALY



france
valsir[®]
QUALITY FOR PLUMBING

SOMMAIRE

MULTICOUCHE

TUBES MULTICOUCHE ALU	38
RACCORDS MULTICOUCHE A SERTIR	38
RACCORDS MULTICOUCHE A SERTIR ET A VISSER	41

PER

TUBES PER	45
RACCORDS PER A SERTIR	45
RACCORDS PER A SERTIR ET A VISSER	46
RACCORDS PER A GLISSEMENT	46
RACCORDS PER A GLISSEMENT ET A VISSER	47

CUIVRE ET LAITON

TUBES CUIVRE	49
RACCORDS CUIVRE A SOUDER	49
RACCORDS CUIVRE A SERTIR	52
RACCORDS CUIVRE A SERTIR ET A VISSER	54
RACCORDS LAITON A SOUDER ET A VISSER	56
RACCORDS LAITON A VISSER	59
RACCORDS LAITON RAPIDE	64

COLLECTEUR ET ACCESSOIRES

COLLECTEUR SANITAIRE ET CHAUFFAGE	65
COLLECTEUR PANCHER CHAUFFANT	66

PVC EVACUATION

TUBES ET RACCORDS PVC EVACUATION	67
TUBES ET RACCORDS PVC EVACUATION ACOUSTIQUE	77
RACCORDS PVC SANITAIRE	77
AERATION	79
REGARDS, SIPHONS ET CANIVEAUX	80
ASSAINISSEMENT	80

FONTE

COLONNES ET RACCORDS FONTE EVACUATION	81
---	----

PVC PRESSION

TUBES ET RACCORDS PVC PRESSION	86
--------------------------------------	----

PVC PRESSION TECHNIQUE

TUBES ET RACCORDS PVC PRESSION EAU CHAUDE	90
TUBES ET RACCORDS PVC PRESSION EAU GLACEE	92

POLYETHYLENE

TUBES POLYETHYLENE	93
RACCORDS LAITON POUR PE	93

ACIER

TUBES ACIER GALVA	95
RACCORDS ACIER GALVA A SOUDER	96
RACCORDS ACIER GALVA A VISSER	96
RACCORDS ACIER GALVA A SERTIR	97
RACCORDS FONTE MALLEABLE GALVA	97
TUBES ACIER NOIR	102
RACCORDS ACIER NOIR A SOUDER	102
RACCORDS ACIER NOIR A VISSER	104
RACCORDS FONTE MALLEABLE NOIR	105
RACCORDS PETROLE	108
TUBES ACIER ELECTROZINGUE	108
RACCORDS ACIER ELECTROZINGUE A SERTIR	109
RACCORDS ACIER ELECTROZINGUE A SERTIR ET A VISSER	110
RACCORDS DE REPARATION ACIER	111

INOX

TUBES INOX	112
RACCORDS INOX A SERTIR	112
RACCORDS INOX A SERTIR ET A VISSER	114
SIPHONS DE SOL/CANIVEAU INOX	115

ISOLATION

GAINES ISOLANTES	116
PROTECTION	117

MULTICOUCHE

TUBES MULTICOUCHE ALU

■ GEBERIT
TUBE MULTICOUCHE MEPLA

Barre



	DÉSIGNATION	UT	CODE	PPHT (€)	ECOPART (€)
265.0003.16	TUBE MEPLA 16 -BARRE 5M- GEBERIT 601100001	M	93436.4	4,53	0,01
265.0004.49	TUBE MEPLA 20 -BARRE 5M- GEBERIT 602100001	M	93438.0	6,43	0,01
265.0007.53	TUBE MEPLA 26 -BARRE 5M- GEBERIT 603100001	M	93439.8	10,77	0,01
265.0010.16	TUBE MEPLA 32 -BARRE 5M- GEBERIT 604100001	M	93441.4	14,53	0,02
265.0018.40	TUBE MEPLA 40 -BARRE 5M- GEBERIT 605100001	M	93442.2	26,32	0,03
265.0022.41	TUBE MEPLA 50 -BARRE 5M- GEBERIT 606100001	M	0218H.1	32,05	0,04
265.0035.44	TUBE MEPLA 63 -BARRE 5M- GEBERIT 607100001	M	1013H.6	50,68	0,05
265.0056.31	TUBE MEPLA 75 -BARRE 5M- GEBERIT 608100001	M	3674G.4	80,50	0,06

■ GEBERIT
TUBE MULTICOUCHE MEPLA

Couronne



	DÉSIGNATION	UT	CODE	PPHT (€)	ECOPART (€)
265.0002.72	TUBE MEPLA 16 NU -C. 50M- GEBERIT 601130001	M	6939B.9	3,90	0,01
265.0003.75	TUBE MEPLA 20 NU -C. 50M- GEBERIT 602130001	M	6942B.4	5,36	0,01
265.0003.75	TUBE MEPLA 20 NU -C. 100M- GEBERIT 602130002	M	2384I.3	5,36	0,01
265.0006.41	TUBE MEPLA 26 NU -C. 50M- GEBERIT 603110001	M	6941B.5	9,17	0,01

valsir
 QUALITY FOR PLUMBING
TUBE MULTICOUCHE MIXAL

Couronne



	DÉSIGNATION	UT	CODE	PPHT (€)
145.0001.24	TUBE MULTICOUCHE MIXAL 16X2-C.100M- VS0100137	M	6623K.2	2,26
145.0002.10	TUBE MULTICOUCHE MIXAL 20X2-C.100M- VS0100139	M	6624A.5	3,82
145.0003.77	TUBE MULTICOUCHE MIXAL 26X3-C. 50M- VS0100143	M	6624A.1	6,85
145.0005.24	TUBE MULTICOUCHE MIXAL 32X3-C. 50M- VS0100145	M	2351X.4	9,52

valsir
 QUALITY FOR PLUMBING
TUBE MULTICOUCHE MIXAL

Isolé avec gaine auto extinguable - Revêtement 6 mm



	DÉSIGNATION	UT	CODE	PPHT (€)
145.0002.16	TUBE MIXAL ISO.16X2 GRIS EP6MM C50M VS0100237	M	7045T.4	3,93
145.0002.69	TUBE MIXAL ISO.20X2 GRIS EP6MM C50M VS0100239	M	7045V.9	4,89
145.0005.81	TUBE MIXAL ISO.26X3 GRIS EP6MM C50M VS0100243	M	7045W.7	10,57
145.0010.56	TUBE MIXAL ISO.32X3 GRIS 10MM C25M VS0100245	M	8869U.2	17,60

MULTICOUCHE

TUBES MULTICOUCHE ALU

valsir
 QUALITY FOR PLUMBING
TUBE MULTICOUCHE MIXAL

Revêtu avec gaine annelée



	DÉSIGNATION	UT	CODE	PPHT (€)
145.0002.06	TUBE MIXAL D.16X2 GAINÉ BLEU -M.50- VS0125135	M	6939I.1	3,75
145.0002.06	TUBE MIXAL D.16X2 GAINÉ RGE -M.50- VS0125137	M	6939F.0	3,75
145.0003.32	TUBE MIXAL D.20X2 GAINÉ BLEU -M.50- VS0125139	M	6940C.4	6,03
145.0003.32	TUBE MIXAL D.20X2 GAINÉ RGE -M.50- VS0125141	M	6940G.5	6,03

valsir
 QUALITY FOR PLUMBING
TUBE MULTICOUCHE PEXAL

Barre



	DÉSIGNATION	UT	CODE	PPHT (€)
145.0001.80	TUBE MULTICOUCHE PEXAL 16X2-BAR.5M-VS0100007F	M	0189K.1	3,28
145.0002.96	TUBE MULTICOUCHE PEXAL 20X2-BAR.5M-VS0100015F	M	0189L.9	5,38
145.0004.58	TUBE MULTICOUCHE PEXAL 26X3-BAR.5M-VS0100017F	M	01900.0	8,32
145.0006.99	TUBE MULTICOUCHE PEXAL 32X3-BAR.5M-VS0100021F	M	01901.8	12,71
145.0010.36	TUBE MULTICOUCHE PEXAL 40X3-5-B.5M-VS0100025F	M	01904.2	18,83
145.0014.67	TUBE MULTICOUCHE PEXAL 50X4-BAR.5M-VS0100029F	M	01908.3	26,68
145.0026.11	TUBE MULTICOUCHE PEXAL 63X4-5-B.5M-VS0100033F	M	01908.6	47,48
145.0046.06	TUBE MULTICOUCHE PEXAL 75X5-BAR.5M VS0100034F	M	29451.5	83,75

RACCORDS MULTICOUCHE A SERTIR

■ GEBERIT
BOUCHON MULTICOUCHE MEPLA

Mâle - Avec joint torique EPDM



	DÉSIGNATION	UT	CODE	PPHT (€)	ECOPART (€)
265.0003.47	BOUCHON A SERT.MEPLA 16 GEBERIT 621000005	U	1014E.1	4,95	
265.0004.19	BOUCHON A SERT.MEPLA 20 GEBERIT 622000005	U	1608C.8	5,99	0,01
265.0004.30	BOUCHON A SERT.MEPLA 26 GEBERIT 623000005	U	1196I.3	6,15	0,01

■ GEBERIT
COUDE MULTICOUCHE MEPLA

MM - 45°



	DÉSIGNATION	UT	CODE	PPHT (€)	ECOPART (€)
265.0007.76	COUDE 45 A SERT.MEPLA 26 GEBERIT 623245005	U	6439A.0	11,09	0,01
265.0010.15	COUDE 45 A SERT.MEPLA 32 GEBERIT 624245005	U	0218E.7	14,51	0,01
265.0014.44	COUDE 45 A SERT.MEPLA 40 GEBERIT 625245005	U	9127C.3	20,64	0,01
265.0022.78	COUDE 45 A SERT.MEPLA 50 GEBERIT 626245005	U	25237.9	32,55	0,01
265.0037.34	COUDE 45 A SERT.MEPLA 63 GEBERIT 627245005	U	3674H.2	53,36	0,02
265.0080.36	COUDE 45 A SERT.MEPLA 75 GEBERIT 628245005	U	3674I.0	114,83	0,03

Le PPHT comprend l'ecopart (€)

MULTICOUCHE

RACCORDS MULTICOUCHE A SERTIR

■ GEBERIT COUDE MULTICOUCHE MEPLA MM - 90°



	DÉSIGNATION	UT	CODE	PPHT (€)	ECOPART (€)
265.0004.73	COUDE 90 A SERT.MEPLA 16 GEBERIT 621271005	U	6882B.6	6,77	0,01
265.0005.43	COUDE 90 A SERT.MEPLA 20 GEBERIT 622271005	U	6885B.3	7,75	
265.0007.76	COUDE 90 A SERT.MEPLA 26 GEBERIT 623271005	U	6932B.6	11,09	0,01
265.0010.15	COUDE 90 A SERT.MEPLA 32 GEBERIT 624271005	U	6888B.0	14,51	0,01
265.0014.44	COUDE 90 A SERT.MEPLA 40 GEBERIT 625271005	U	9130C.8	20,64	0,01
265.0022.78	COUDE 90 A SERT.MEPLA 50 GEBERIT 626271005	U	2523B.7	32,55	0,01
265.0037.23	COUDE 90 A SERT.MEPLA 63 GEBERIT 627271005	U	2972I.1	53,21	0,02
265.0081.75	COUDE 90 A SERT.MEPLA 75 GEBERIT 628271005	U	3674J.9	116,82	0,04

■ GEBERIT MANCHON MULTICOUCHE MEPLA MM



	DÉSIGNATION	UT	CODE	PPHT (€)	ECOPART (€)
265.0003.61	MANCHON MEPLA 16 GEBERIT 621505005	U	6892B.4	5,16	0,01
265.0004.19	MANCHON MEPLA 20 GEBERIT 622505005	U	6893B.3	5,99	0,01
265.0005.01	MANCHON MEPLA 26 GEBERIT 623505005	U	6931B.7	7,16	0,01
265.0007.06	MANCHON MEPLA 32 GEBERIT 624505005	U	60037.9	10,10	0,01
265.0011.51	MANCHON MEPLA 40 GEBERIT 625505005	U	005LE.6	16,46	0,01
265.0015.69	MANCHON MEPLA 50 GEBERIT 626505005	U	1014J.2	22,43	0,01
265.0031.23	MANCHON MEPLA 63 GEBERIT 627505005	U	1014K.0	44,63	0,01
265.0068.42	MANCHON MEPLA 75 GEBERIT 628505005	U	3675L.4	97,77	0,03

■ GEBERIT TE MULTICOUCHE MEPLA MMM - égal



	DÉSIGNATION	UT	CODE	PPHT (€)	ECOPART (€)
265.0008.47	TE EGAL A SERT.MEPLA 16 GEBERIT 621310005	U	6884B.4	12,11	0,01
265.0008.86	TE EGAL A SERT.MEPLA 20 GEBERIT 622310005	U	6883B.5	12,67	0,01
265.0010.15	TE EGAL A SERT.MEPLA 26 GEBERIT 623310005	U	60014.8	14,51	0,01
265.0012.65	TE EGAL A SERT.MEPLA 32 GEBERIT 624310005	U	6886B.2	18,08	0,01
265.0017.76	TE EGAL A SERT.MEPLA 40 GEBERIT 625310005	U	9133C.5	25,38	0,01
265.0026.49	TE EGAL A SERT.MEPLA 50 GEBERIT 626310005	U	1648E.5	37,85	0,01
265.0059.29	TE EGAL A SERT.MEPLA 63 GEBERIT 627310005	U	1015A.9	84,73	0,03
265.0130.19	TE EGAL A SERT.MEPLA 75 GEBERIT 628310005	U	3674K.7	186,05	0,06

■ GEBERIT TE MULTICOUCHE MEPLA MMM - Réduit



	DÉSIGNATION	UT	CODE	PPHT (€)	ECOPART (€)
265.0009.30	TE RED.SERT.MEPLA 20X16X16 GEBERIT 622314005	U	6891B.5	13,30	0,01
265.0008.61	TE RED.SERT.MEPLA 20X16X20 GEBERIT 622311005	U	6887B.1	12,31	0,01
265.0008.61	TE RED.SERT.MEPLA 20X20X16 GEBERIT 622312005	U	6889B.9	12,31	0,01
265.0008.76	TE RED.SERT.MEPLA 20X26X20 GEBERIT 623318005	U	3675I.6	12,52	0,01

Le PPHT comprend l'ecopart (€)

MULTICOUCHE

RACCORDS MULTICOUCHE A SERTIR

■ GEBERIT TE MULTICOUCHE MEPLA MMM - Réduit - suite



	DÉSIGNATION	UT	CODE	PPHT (€)	ECOPART (€)
265.0010.94	TE RED.SERT.MEPLA 26X16X26 GEBERIT 623311005	U	6937B.1	15,64	0,01
265.0010.94	TE RED.SERT.MEPLA 26X20X20 GEBERIT 623317005	U	36750.8	15,64	0,01
265.0010.94	TE RED.SERT.MEPLA 26X20X26 GEBERIT 623315005	U	6943B.3	15,64	0,01
265.0010.94	TE RED.SERT.MEPLA 26X26X20 GEBERIT 623316005	U	3674L.5	15,64	0,01
265.0012.35	TE RED.SERT.MEPLA 32X16X32 GEBERIT 624311005	U	0217F.6	17,65	0,01
265.0012.35	TE RED.SERT.MEPLA 32X20X32 GEBERIT 624317005	U	005LC.1	17,65	0,01
265.0012.35	TE RED.SERT.MEPLA 32X20X26 GEBERIT 624314005	U	36752.4	17,65	0,01
265.0012.35	TE RED.SERT.MEPLA 32X26X26 GEBERIT 624316005	U	36753.2	17,65	0,01
265.0012.35	TE RED.SERT.MEPLA 32X26X32 GEBERIT 624319005	U	60019.7	17,65	0,01
265.0017.22	TE RED.SERT.MEPLA 40X20X40 GEBERIT 625317005	U	0217I.0	24,61	0,01
265.0017.22	TE RED.SERT.MEPLA 40X26X40 GEBERIT 625319005	U	0217J.9	24,61	0,01
265.0017.22	TE RED.SERT.MEPLA 40X32X40 GEBERIT 625311005	U	0217K.7	24,61	0,01
265.0027.08	TE RED.SERT.MEPLA 50X26X50 GEBERIT 626317005	U	3057F.3	38,69	0,01
265.0027.08	TE RED.SERT.MEPLA 50X32X50 GEBERIT 626319005	U	3057G.1	38,69	0,01
265.0027.08	TE RED.SERT.MEPLA 50X40X40 GEBERIT 626320005	U	3057H.9	38,69	0,01
265.0027.08	TE RED.SERT.MEPLA 50X40X50 GEBERIT 626321005	U	3057I.7	38,69	0,01
265.0058.27	TE RED.SERT.MEPLA 63X26X63 GEBERIT 627316005	U	1015D.3	83,27	0,02
265.0058.27	TE RED.SERT.MEPLA 63X32X63 GEBERIT 627320005	U	3057J.6	83,27	0,02
265.0058.27	TE RED.SERT.MEPLA 63X40X63 GEBERIT 627321005	U	3057K.4	83,27	0,02
265.0058.27	TE RED.SERT.MEPLA 63X50X63 GEBERIT 627322005	U	3057L.2	83,27	0,02

■ GEBERIT REDUCTION MULTICOUCHE MEPLA MM



	DÉSIGNATION	UT	CODE	PPHT (€)	ECOPART (€)
265.0004.19	REDUCTION SERT.MEPLA 20X16 GEBERIT 622650005	U	6895B.1	5,99	0,01
265.0004.85	REDUCTION SERT.MEPLA 26X16 GEBERIT 623650005	U	64453.4	6,94	0,01
265.0004.85	REDUCTION SERT.MEPLA 26X20 GEBERIT 623651005	U	6933B.5	6,94	0,01
265.0007.06	REDUCTION SERT.MEPLA 32X20 GEBERIT 624651005	U	10155.0	10,10	0,01
265.0007.06	REDUCTION SERT.MEPLA 32X26 GEBERIT 624652005	U	60098.1	10,10	0,01
265.0012.65	REDUCTION SERT.MEPLA 40X20 GEBERIT 625651005	U	30588.8	18,08	0,01
265.0012.49	REDUCTION SERT.MEPLA 40X26 GEBERIT 625652005	U	1607L.1	17,86	0,01
265.0012.65	REDUCTION SERT.MEPLA 40X32 GEBERIT 625653005	U	005LD.9	18,08	0,01
265.0015.37	REDUCTION SERT.MEPLA 50X32 GEBERIT 626652005	U	3058D.7	21,97	0,01
265.0015.37	REDUCTION SERT.MEPLA 50X40 GEBERIT 626653005	U	3058E.4	21,97	0,01
265.0031.37	REDUCTION SERT.MEPLA 63X40 GEBERIT 627653005	U	3058F.2	44,83	0,01
265.0031.37	REDUCTION SERT.MEPLA 63X50 GEBERIT 627654005	U	3058G.0	44,83	0,01
265.0068.01	REDUCTION SERT.MEPLA 75X50 GEBERIT 628654005	U	36763.1	97,17	0,02
265.0068.42	REDUCTION SERT.MEPLA 75X63 GEBERIT 628655005	U	36768.0	97,76	0,02

valsir QUALITY FOR PLUMBING RACCORD MULTICOUCHE PEXAL FF - Passerelle - Pexal vers cuivre



	DÉSIGNATION	UT	CODE	PPHT (€)
376.0007.82	RACCORD PASSER.PEXAL 16 CUIVRE 14 VS0171303	U	6343H.6	13,03
376.0007.82	RACCORD PASSER.PEXAL 16X2 CUIVRE 16 VS0171305	U	6343C.7	13,03

MULTICOUCHE

RACCORDS MULTICOUCHE A SERTIR

valsir
QUALITY FOR PLUMBING

RACCORD MULTICOUCHE PEXAL
FF - Passerelle - Pexal vers cuivre
- suite



	DÉSIGNATION	UT	CODE	PPHT (€)
376.0009.28	RACCORD PASSER.PEXAL 20 CUIVRE 22 VS0171312	U	237NF.1	15,47

valsir
QUALITY FOR PLUMBING

RACCORD MULTICOUCHE PEXAL
FF - Passerelle - Pexal vers PER



	DÉSIGNATION	UT	CODE	PPHT (€)
376.0006.16	RACCORD PASSER.PEXAL 16X2 PER16X1.5 VS0171351	U	6330U.7	10,26
376.0006.65	RACCORD PASSER.PEXAL 20X2 PER20X1.9 VS0171353	U	6343E.2	11,09
376.0010.10	RACCORD PASSER.PEXAL 20X2 PER 16 VS0171355	U	185Q2.4	10,10

valsir
QUALITY FOR PLUMBING

TE MULTICOUCHE PEXAL
MMM - Egal



	DÉSIGNATION	UT	CODE	PPHT (€)
376.0006.51	TE DE RACCORD. PEXAL 16 VS0170703	U	6333W.0	10,85
376.0008.24	TE DE RACCORD. PEXAL 20 VS0170709	U	6343P.3	13,74
376.0013.27	TE DE RACCORD. PEXAL 26 VS0170713	U	6343M.7	22,11
376.0021.32	TE DE RACCORD. PEXAL 32 VS0170715	U	6342N.6	35,53
377.0044.81	TE DE RACCORD. PEXAL 40 VS0131125	U	75215.4	74,69
377.0064.46	TE DE RACCORD. PEXAL 50 VS0131135	U	9462B.8	107,43
377.0114.74	TE DE RACCORD. PEXAL 63 VS0131141	U	90136.3	191,24
377.0212.64	TE DE RACCORD. PEXAL 75 VS0131143	U	2946F.0	354,40

valsir
QUALITY FOR PLUMBING

TE MULTICOUCHE PEXAL
FFF - Réduit



	DÉSIGNATION	UT	CODE	PPHT (€)
376.0009.38	TE DE RACCORD.RED. PEXAL 16X20X16 VS0170807	U	6346R.6	15,64
376.0008.24	TE DE RACCORD.RED. PEXAL 20X16X20 VS0170819	U	6343L.9	13,74
376.0008.24	TE DE RACCORD.RED. PEXAL 20X16X16 VS0170815	U	6341S.9	13,74
376.0010.66	TE DE RACCORD.RED. PEXAL 20X20X16 VS0170825	U	6341V.2	17,76
376.0018.82	TE DE RACCORD.RED. PEXAL 20X26X20 VS0170829	U	6346W.5	31,36
376.0016.82	TE DE RACCORD.RED. PEXAL 26X16X26 VS0170833	U	6334C.8	28,03
376.0017.53	TE DE RACCORD.RED. PEXAL 26X20X20 VS0170839	U	6346P.0	29,21
376.0017.77	TE DE RACCORD.RED. PEXAL 26X20X26 VS0170843	U	6342P.4	29,61
376.0019.04	TE DE RACCORD.RED. PEXAL 26X26X20 VS0170847	U	6346T.2	31,73
376.0020.72	TE DE RACCORD.RED. PEXAL 32X16X32 VS0170851	U	6332W.1	34,54
376.0020.14	TE DE RACCORD.RED. PEXAL 32X20X32 VS0170853	U	63337.0	33,56
376.0021.65	TE DE RACCORD.RED. PEXAL 32X26X26 VS0170857	U	6344K.0	36,08
376.0022.00	TE DE RACCORD.RED. PEXAL 32X26X32 VS0170859	U	6346S.4	36,67
377.0042.59	TE DE RACCORD.RED. PEXAL 40X20X40 VS0170861	U	6330X.1	70,98

MULTICOUCHE

RACCORDS MULTICOUCHE A SERTIR

valsir
QUALITY FOR PLUMBING

TE MULTICOUCHE PEXAL
FFF - Réduit
- suite



	DÉSIGNATION	UT	CODE	PPHT (€)
377.0042.59	TE DE RACCORD.RED. PEXAL 40X26X40 VS0170863	U	6332V.3	70,98
377.0043.28	TE DE RACCORD.RED. PEXAL 40X32X32 VS0170864	U	6341Y.6	72,13
377.0043.28	TE DE RACCORD.RED. PEXAL 40X32X40 VS0170865	U	6332B.2	72,13
377.0043.28	TE DE RACCORD.RED. PEXAL 40X40X32 VS0170866	U	6346U.9	72,13
377.0051.86	TE DE RACCORD.RED. PEXAL 50X26X50 VS0170867	U	6346D.2	86,44
377.0051.86	TE DE RACCORD.RED. PEXAL 50X32X50 VS0170869	U	6332Q.4	86,44
377.0061.11	TE DE RACCORD.RED. PEXAL 50X40X50 VS0131755	U	90438.3	101,85
377.0113.87	TE DE RACCORD.RED. PEXAL 63X32X63 VS0170871	U	6333J.5	189,79
377.0124.91	TE DE RACCORD.RED. PEXAL 63X40X63 VS0131759	U	90476.3	208,19
377.0124.91	TE DE RACCORD.RED. PEXAL 63X50X63 VS0131761	U	90485.4	208,19

valsir
QUALITY FOR PLUMBING

MANCHON MULTICOUCHE PEXAL
FF - Egal



	DÉSIGNATION	UT	CODE	PPHT (€)
376.0004.00	MANCHON DE RACCORD. PEXAL 16X16 VS0170003	U	6341W.0	6,67
376.0004.95	MANCHON DE RACCORD. PEXAL 20X20 VS0170009	U	6332S.0	8,25
376.0008.53	MANCHON DE RACCORD. PEXAL 26X26 VS0170013	U	6332Y.7	14,21
376.0013.03	MANCHON DE RACCORD. PEXAL 32X32 VS0170015	U	6332M.0	21,71
377.0028.92	MANCHON DE RACCORD. PEXAL 40X40 VS0130525	U	75292.3	48,20
377.0040.68	MANCHON DE RACCORD. PEXAL 50X50 VS0130529	U	82301.3	67,80
377.0065.72	MANCHON DE RACCORD. PEXAL 63X63 VS0130533	U	89844.5	109,54
377.0133.22	MANCHON DE RACCORD. PEXAL 75X75 VS0130535	U	2945J.4	222,03

valsir
QUALITY FOR PLUMBING

MANCHON MULTICOUCHE PEXAL
FF - Réduit



	DÉSIGNATION	UT	CODE	PPHT (€)
376.0005.71	MANCHON DE RACCORD.RED. PEXAL 20X16 VS0170119	U	6331N.9	9,51
376.0007.96	MANCHON DE RACCORD.RED. PEXAL 26X16 VS0170127	U	6332P.6	13,26
376.0009.38	MANCHON DE RACCORD.RED. PEXAL 26X20 VS0170131	U	6332N.8	15,63
376.0013.17	MANCHON DE RACCORD.RED. PEXAL 32X16 VS0170143	U	6346N.2	21,95
376.0013.43	MANCHON DE RACCORD.RED. PEXAL 32X20 VS0170145	U	6331P.7	22,38
376.0013.43	MANCHON DE RACCORD.RED. PEXAL 32X26 VS0170149	U	6331S.1	22,38
377.0026.19	MANCHON DE RACCORD.RED. PEXAL 40X26 VS0170159	U	6332X.9	43,65
377.0027.97	MANCHON DE RACCORD.RED. PEXAL 40X32 VS0170161	U	6332A.4	46,61
377.0032.54	MANCHON DE RACCORD.RED. PEXAL 50X32 VS0170171	U	6331M.1	54,24
377.0036.26	MANCHON DE RACCORD.RED. PEXAL 50X40 VS0130577	U	89898.1	60,44
377.0064.52	MANCHON DE RACCORD.RED. PEXAL 63X40 VS0130579	U	89903.9	107,54
377.0063.27	MANCHON DE RACCORD.RED. PEXAL 63X50 VS0130581	U	89910.4	105,45
377.0102.71	MANCHON DE RACCORD.RED. PEXAL 75X50 VS0130583	U	2945K.2	171,18
377.0111.64	MANCHON DE RACCORD.RED. PEXAL 75X63 VS0130585	U	2945L.0	186,07

MULTICOUCHE

RACCORDS MULTICOUCHE A SERTIR



COUDE MULTICOUCHE PEXAL
FF - 45° - Egal



	DÉSIGNATION	UT	CODE	PPHT (€)
377.0041.63	COUDE 45°DE RACCORD. PEXAL 40X40 VS0130849	U	48286.7	69,39
377.0056.89	COUDE 45°DE RACCORD. PEXAL 50X50 VS0130850	U	4828H.5	94,82
377.0106.16	COUDE 45°DE RACCORD. PEXAL 63X63 VS0130851	U	2947B.8	176,93
377.0160.19	COUDE 45°DE RACCORD. PEXAL 75X75 VS0130853	U	2946E.2	266,99



COUDE MULTICOUCHE PEXAL
FF - 90° - Egal



	DÉSIGNATION	UT	CODE	PPHT (€)
376.0004.71	COUDE 90°DE RACCORD. PEXAL 16X16 VS0170403	U	6344C.6	7,85
376.0006.06	COUDE 90°DE RACCORD. PEXAL 20X20 VS0170409	U	6341X.8	10,10
376.0009.95	COUDE 90°DE RACCORD. PEXAL 26X26 VS0170413	U	6342F.1	16,58
376.0015.16	COUDE 90°DE RACCORD. PEXAL 32X32 VS0170415	U	63445.1	25,27
377.0030.64	COUDE 90°DE RACCORD. PEXAL 40X40 VS0130827	U	75320.2	51,06
377.0048.82	COUDE 90°DE RACCORD. PEXAL 50X50 VS0130833	U	9460B.0	81,37
377.0088.04	COUDE 90°DE RACCORD. PEXAL 63X63 VS0130841	U	9461B.9	146,74
377.0162.42	COUDE 90°DE RACCORD. PEXAL 75X75 VS0130843	U	2946D.5	270,70

RACCORDS MULTICOUCHE A SERTIR ET A VISSER

■ GEBERIT
COUDE MULTICOUCHE MEPLA
MF - 90° - Bronze



	DÉSIGNATION	UT	CODE	PPHT (€)	ECOPART (€)
265.0008.12	COUDE 90 TAR.MEPLA L.16X1/2 GEBERIT 611256005	U	59986.0	11,61	0,01
265.0013.13	COUDE 90 TAR.MEPLA L.20X1/2 GEBERIT 612256005	U	59996.9	18,76	0,01
265.0017.71	COUDE 90 TAR.MEPLA L.32X1 GEBERIT 614258005	U	60009.8	25,31	0,01

■ GEBERIT
COUDE MULTICOUCHE MEPLA
MM - 90° - Bronze



	DÉSIGNATION	UT	CODE	PPHT (€)	ECOPART (€)
265.0051.95	COUDE 90 FIL.MEPLA 50-11/2 GEBERIT 606255005	U	07486.4	74,25	0,03

Le PPHT comprend l'ecopart (€)

MULTICOUCHE

RACCORDS MULTICOUCHE A SERTIR ET A VISSER

■ GEBERIT
COUDE MULTICOUCHE MEPLA
MM - 90° - Laiton



	DÉSIGNATION	UT	CODE	PPHT (€)	ECOPART (€)
265.0007.67	COUDE 90 FIL.MEPLA L.16X1/2 GEBERIT 611252005	U	6928B.2	10,96	0,01
265.0008.86	COUDE 90 FIL.MEPLA L.20X1/2 LAITON 612252005	U	1015E.0	12,67	0,01
265.0018.46	COUDE 90 FIL.MEPLA L.32X1 GEBERIT 614254005	U	7622I.4	26,38	0,01
265.0021.83	COUDE 90 FIL.MEPLA L40X11/4 GEBERIT 615255005	U	0272D.3	31,21	0,02

■ GEBERIT
APPLIQUE MULTICOUCHE MEPLA
MF - 90° - Laiton



	DÉSIGNATION	UT	CODE	PPHT (€)	ECOPART (€)
265.0011.96	APPLIQUE 90 MEPLA L. 16X1/2 GEBERIT 611293005	U	01715.2	17,10	0,01
265.0012.99	APPLIQUE 90 MEPLA L. 20X1/2 GEBERIT 612293005	U	6862B.0	18,57	0,01

■ GEBERIT
APPLIQUE MULTICOUCHE MEPLA
Kit applique 90°



	DÉSIGNATION	UT	CODE	PPHT (€)	ECOPART (€)
265.0076.11	APPLIQUE 90° MEPLA DBLE D16 5.8CM 611777005	U	8390F.8	76,13	0,02
265.0092.00	APPLIQUE 90° MEPLA DBLE D20 6.1CM 612777005	U	8390M.5	92,02	0,02

■ GEBERIT
TE MULTICOUCHE MEPLA
MFM - mixte - Bronze



	DÉSIGNATION	UT	CODE	PPHT (€)	ECOPART (€)
265.0032.33	TE TAR.MEPLA B.40X1/2X40 GEBERIT 605360005	U	36781.3	46,20	0,02
265.0032.33	TE TAR.MEPLA B.40X1/4X40 GEBERIT 605363005	U	1014L.8	46,20	0,02
265.0033.03	TE TAR.MEPLA B.40X11/4X40 GEBERIT 605364005	U	7862E.1	47,21	0,02
265.0053.73	TE TAR.MEPLA B.50X1X50 GEBERIT 606363005	U	10150.1	76,78	0,03
265.0053.99	TE TAR.MEPLA B.50X11/2X50 GEBERIT 606360005	U	9561L.8	77,17	0,04
265.0152.88	TE TAR.MEPLA B.63X1/2X63 GEBERIT 607360005	U	6394H.4	218,47	0,07
265.0152.88	TE TAR.MEPLA B.63X1X63 GEBERIT 607363005	U	6394G.6	218,47	0,07
265.0233.16	TE TAR.MEPLA B.75X1X75 GEBERIT 608363005	U	3675K.6	333,22	0,14

■ GEBERIT
TE MULTICOUCHE MEPLA
MFM - mixte - Laiton



	DÉSIGNATION	UT	CODE	PPHT (€)	ECOPART (€)
265.0011.22	TE TAR.MEPLA L.16X1/2X16 GEBERIT 611362005	U	60025.4	16,04	0,01
265.0013.57	TE TAR.MEPLA L.20X1/2X20 GEBERIT 612360005	U	6894B.2	19,39	0,01
265.0015.36	TE TAR.MEPLA L.26X1/2X26 GEBERIT 613360005	U	60030.4	21,95	0,01
265.0015.51	TE TAR.MEPLA L.26X3/4X26 GEBERIT 613362005	U	98526.7	22,17	0,01
265.0018.88	TE TAR.MEPLA L.32X1/2X32 GEBERIT 614360005	U	60034.6	26,98	0,01

MULTICOUCHE

RACCORDS MULTICOUCHE A SERTIR ET A VISSER

■ GEBERIT
TE MULTICOUCHE MEPLA
MFM - mixte - Laiton
- suite



	DÉSIGNATION	UT	CODE	PPHT (€)	ECOPART (€)
265.0018.88	TE TAR.MEPLA L.32X3/4X32 GEBERIT 614362005	U	0218D.0	26,98	0,01

■ GEBERIT
JONCTION MULTICOUCHE MEPLA
MF - Bronze



	DÉSIGNATION	UT	CODE	PPHT (€)	ECOPART (€)
265.0016.82	JONCTION F.MEPLA B.40X1 GEBERIT 605557005	U	8519C.1	24,04	0,01
265.0016.82	JONCTION F.MEPLA B.40X11/4 GEBERIT 605558005	U	9121C.9	24,05	0,02
265.0040.00	JONCTION F.MEPLA B.50X11/2 GEBERIT 606559005	U	2523E.3	57,16	0,02
265.0040.00	JONCTION F.MEPLA B.50X2 GEBERIT 606560005	U	2523G.9	57,17	0,03
265.0062.00	JONCTION F.MEPLA B.63X2 GEBERIT 607560005	U	2972J.0	88,62	0,05
265.0119.39	JONCTION F.MEPLA B.75X21/2 GEBERIT 608561005	U	5554G.4	170,64	0,09

■ GEBERIT
JONCTION MULTICOUCHE MEPLA
MF - Laiton



	DÉSIGNATION	UT	CODE	PPHT (€)	ECOPART (€)
265.0006.28	JONCTION F.MEPLA L.16X3/8 GEBERIT 611554005	U	4945K.8	8,98	0,01
265.0004.73	JONCTION F.MEPLA L.16X1/2 GEBERIT 611555005	U	6896B.0	6,77	0,01
265.0005.30	JONCTION F.MEPLA L.20X1/2 GEBERIT 612555005	U	60073.4	7,58	0,01
265.0005.30	JONCTION F.MEPLA L.20X3/4 GEBERIT 612556005	U	6897B.9	7,58	0,01
265.0007.83	JONCTION F.MEPLA L.26X3/4 GEBERIT 613556005	U	60080.9	11,19	0,01
265.0007.83	JONCTION F.MEPLA L.26X1 GEBERIT 613557005	U	3676F.4	11,19	0,01
265.0015.51	JONCTION F.MEPLA L.32X1 GEBERIT 614557005	U	6898B.8	22,17	0,01

■ GEBERIT
JONCTION MULTICOUCHE MEPLA
MF - Avec écrou - Bronze



	DÉSIGNATION	UT	CODE	PPHT (€)	ECOPART (€)
265.0023.34	JONCTION F.ECR.MEPLA 26X3/4 GEBERIT 603595005	U	64509.3	33,35	0,01
265.0032.91	JONCTION F.ECR.MEPLA 32X1 GEBERIT 604595005	U	36774.8	47,02	0,01
265.0045.02	JONCTION F.ECR.MEPLA 40X11/2 GEBERIT 605596005	U	36779.7	64,35	0,03

■ GEBERIT
JONCTION MULTICOUCHE MEPLA
MF - Avec écrou - Avec joint torique
EPDM et joint d'étanchéité plat



	DÉSIGNATION	UT	CODE	PPHT (€)	ECOPART (€)
265.0013.43	JONCTION+ECR.JP BRZ 16X1/2 GEBERIT 601582005	U	2187C.5	19,19	0,01
265.0012.10	JONCTION+ECR.JP BRZ 16X3/4 GEBERIT 601583005	U	2190C.0	17,30	0,01

MULTICOUCHE

RACCORDS MULTICOUCHE A SERTIR ET A VISSER

■ GEBERIT
JONCTION MULTICOUCHE MEPLA
MF - Avec écrou - Avec joint torique
EPDM et joint d'étanchéité plat
- suite



	DÉSIGNATION	UT	CODE	PPHT (€)	ECOPART (€)
265.0012.10	JONCTION+ECR.JP BRZ 20X1/2 GEBERIT 602582005	U	2193C.7	17,30	0,01
265.0012.10	JONCTION+ECR.JP BRZ 20X3/4 GEBERIT 602583005	U	6899B.7	17,30	0,01
265.0015.65	JONCTION+ECR.JP BRZ 26X3/4 GEBERIT 603583005	U	6936B.2	22,36	0,01
265.0023.05	JONCTION+ECR.JP BRZ 32X3/4 GEBERIT 604583005	U	0217L.5	32,94	0,01
265.0012.23	JONCTION+ECR.JP BRZ 20X1 GEBERIT 602584005	U	2196C.4	17,48	0,01
265.0015.79	JONCTION+ECR.JP BRZ 26X1 GEBERIT 603584005	U	6935B.3	22,56	0,01
265.0023.05	JONCTION+ECR.JP BRZ 32X1 GEBERIT 604584005	U	6900B.4	32,94	0,01
265.0015.65	JONCTION+ECR.JP BRZ 26X1/2 GEBERIT 603582005	U	32994.6	22,36	0,01
265.0028.34	JONCTION+ECR.JP BRZ40X1.1/2 GEBERIT 605585005	U	3677L.2	40,50	0,02
265.0041.16	JONCTION+ECR.JP BRZ50X11/2 GEBERIT 606585005	U	2523J.4	58,82	0,02
265.0015.65	JONCTION+ECR.JP BRZ26X11/4 GEBERIT 603586005	U	3677G.1	22,36	0,01
265.0022.87	JONCTION+ECR.JP BRZ32X11/4 GEBERIT 604586005	U	33752.7	32,68	0,01
265.0029.51	JONCTION+ECR.JP BRZ40X11/4 GEBERIT 605589005	U	9124C.6	42,17	0,01
265.0041.35	JONCTION+ECR.JP BRZ 50X2 GEBERIT 606581005	U	2523I.5	59,09	0,02
265.0074.25	JONCTION+ECR.JP BRZ 63X2 GEBERIT 607581005	U	2972K.8	106,11	0,04
265.0074.37	JONCTION+ECR.JP BRZ63X21/2 GEBERIT 607587005	U	1057T.2	106,29	0,05

■ GEBERIT
JONCTION MULTICOUCHE MEPLA
MM - Bronze



	DÉSIGNATION	UT	CODE	PPHT (€)	ECOPART (€)
265.0007.54	JONCTION M.MEPLA B.16X3/4 GEBERIT 601536005	U	23942.6	10,78	0,01
265.0016.09	JONCTION M.MEPLA B.32X11/4 GEBERIT 604538005	U	3703K.2	22,99	0,01
265.0016.68	JONCTION M.MEPLA B.40X1 GEBERIT 605537005	U	02188.1	23,84	0,01
265.0016.68	JONCTION M.MEPLA B.40X11/4 GEBERIT 605538005	U	9118C.4	23,84	0,01
265.0016.53	JONCTION M.MEPLA B.40X11/2 GEBERIT 605539005	U	0218A.6	23,63	0,01
265.0039.26	JONCTION M.MEPLA B.50X11/2 GEBERIT 606537005	U	2523B.0	56,11	0,02
265.0039.11	JONCTION M.MEPLA B.50X2 GEBERIT 606540005	U	10146.7	55,90	0,03
265.0060.21	JONCTION M.MEPLA B.63X2 GEBERIT 607539005	U	1014H.5	86,06	0,04
265.0115.11	JONCTION M.MEPLA B.75X21/2 GEBERIT 608541005	U	3676A.5	164,53	0,09

■ GEBERIT
JONCTION MULTICOUCHE MEPLA
MM - Laiton



	DÉSIGNATION	UT	CODE	PPHT (€)	ECOPART (€)
265.0005.45	JONCTION M.MEPLA B.16X3/8 GEBERIT 611534005	U	49465.8	7,80	0,01
265.0004.56	JONCTION M.MEPLA B.16X1/2 GEBERIT 611535005	U	6929B.1	6,52	0,01
265.0005.92	JONCTION M.MEPLA B.20X3/8 GEBERIT 612534005	U	49466.6	8,47	0,01
265.0005.17	JONCTION M.MEPLA B.20X1/2 GEBERIT 612535005	U	60043.7	7,40	0,01
265.0005.17	JONCTION M.MEPLA B.20X3/4 GEBERIT 612536005	U	6930B.8	7,40	0,01
265.0007.83	JONCTION M.MEPLA B.26X1/2 GEBERIT 613535005	U	3676C.1	11,19	0,01
265.0007.83	JONCTION M.MEPLA B.26X3/4 GEBERIT 613536005	U	60055.1	11,19	0,01
265.0007.83	JONCTION M.MEPLA B.26X1 GEBERIT 613537005	U	64526.7	11,19	0,01
265.0010.48	JONCTION M.MEPLA B.32X1 GEBERIT 614537005	U	60065.0	14,98	0,01

Le PPHT comprend l'ecopart (€)

MULTICOUCHE

RACCORDS MULTICOUCHE A SERTIR ET A VISSER

GEBERIT
JONCTION MULTICOUCHE MEPLA
MM - Avec écrou - Bronze



	DÉSIGNATION	UT	CODE	PPHT (€)	ECOPART (€)
265.0019.18	JONCTION M.ECR.MEPLA 20X1/2 GEBERIT 602590005	U	3717E.7	27,41	0,01
265.0018.61	JONCTION M.ECR.MEPLA 20X3/4 GEBERIT 602591005	U	5895K.5	26,60	0,01
265.0023.76	JONCTION M.ECR.MEPLA 26X3/4 GEBERIT 603590005	U	3717F.5	33,95	0,01
265.0033.22	JONCTION M.ECR.MEPLA 32X1 GEBERIT 604590005	U	3676G.2	47,48	0,02
265.0046.17	JONCTION M.ECR.MEPLA 40X1/4 GEBERIT 605590005	U	3676I.8	65,98	0,03
265.0081.17	JONCTION M.ECR.MEPLA 50X1/2 GEBERIT 606590005	U	3676K.5	115,99	0,04
265.0081.92	JONCTION M.ECR.MEPLA 50X2 GEBERIT 606591005	U	3676L.3	117,08	0,05
265.0117.17	JONCTION M.ECR.MEPLA 63X2 GEBERIT 607590005	U	3677J.2	167,47	0,09

valsir
QUALITY FOR PLUMBING

COUDE MULTICOUCHE PEXAL
FF - 90°



	DÉSIGNATION	UT	CODE	PPHT (€)
376.0004.97	COUDE 90° FEM. PEXAL 16X1/2 VS0170605	U	6342U.3	8,29
376.0006.44	COUDE 90° FEM. PEXAL 20X1/2 VS0170621	U	6343B.0	10,73
376.0008.30	COUDE 90° FEM. PEXAL 20X3/4 VS0170625	U	6343Y.4	13,83
376.0010.57	COUDE 90° FEM. PEXAL 26X3/4 VS0170635	U	6343V.0	17,61
376.0012.89	COUDE 90° FEM. PEXAL 26X1" VS0170631	U	6347L.5	21,49
376.0017.29	COUDE 90° FEM. PEXAL 32X1" VS0170639	U	6342S.8	28,82
377.0040.12	COUDE 90° FEM. PEXAL 40X1"1/4 VS0130927	U	90012.6	66,87

valsir
QUALITY FOR PLUMBING

COUDE MULTICOUCHE PEXAL
MF - 90°



	DÉSIGNATION	UT	CODE	PPHT (€)
376.0004.97	COUDE 90° MALE PEXAL 16X3/8 VS0170513	U	6344P.2	8,29
376.0005.02	COUDE 90° MALE PEXAL 16X1/2 VS0170505	U	6342X.7	8,37
376.0006.77	COUDE 90° MALE PEXAL 20X1/2 VS0170521	U	6344Z.8	11,29
376.0007.77	COUDE 90° MALE PEXAL 20X3/4 VS0170525	U	6344M.6	12,95
376.0012.70	COUDE 90° MALE PEXAL 26X1" VS0170531	U	6346Q.8	21,17
376.0010.97	COUDE 90° MALE PEXAL 26X3/4 VS0170535	U	6342M.8	18,29
376.0018.20	COUDE 90° MALE PEXAL 32X1" VS0170539	U	6342C.8	30,34
377.0045.56	COUDE 90° MALE PEXAL 40X1"1/4 VS0131027	U	90028.2	75,94

valsir
QUALITY FOR PLUMBING

TE MULTICOUCHE PEXAL
FFF



	DÉSIGNATION	UT	CODE	PPHT (€)
376.0007.96	TE FEMELLE PEXAL 16X1/2"X16 VS0170905	U	6344B.8	13,26
376.0009.89	TE FEMELLE PEXAL 20X1/2"X20 VS0170921	U	6343X.6	16,49
376.0012.14	TE FEMELLE PEXAL 20X3/4"X20 VS0170925	U	6346V.7	20,24
376.0018.24	TE FEMELLE PEXAL 26X3/4"X26 VS0170935	U	6334B.0	30,40

Le PPHT comprend l'ecopart (€)

MULTICOUCHE

RACCORDS MULTICOUCHE A SERTIR ET A VISSER

valsir
QUALITY FOR PLUMBING
TE MULTICOUCHE PEXAL
FFF

- suite



	DÉSIGNATION	UT	CODE	PPHT (€)
376.0023.19	TE FEMELLE PEXAL 32X3/4"X32 VS0170937	U	63311.5	38,65
376.0026.27	TE FEMELLE PEXAL 32X1"X32 VS0170939	U	6343J.3	43,78
377.0035.28	TE FEMELLE PEXAL 40X3/4"X40 VS0131325	U	6812A.3	58,80
377.0045.13	TE FEMELLE PEXAL 40X1"1/4X40 VS0131327	U	9466B.4	75,22
377.0055.43	TE FEMELLE PEXAL 50X3/4"X50 VS0131330	U	6905L.9	92,39
377.0088.36	TE FEMELLE PEXAL 50X1"1/4X50 VS0131331	U	1652C.3	147,27
377.0085.82	TE FEMELLE PEXAL 50X1"1/2X50 VS0131333	U	90224.7	143,03
377.0125.23	TE FEMELLE PEXAL 63X1"X63 VS0131337	U	9321F.0	208,72
377.0157.66	TE FEMELLE PEXAL 63X2"X63 VS0131339	U	90240.3	262,76
377.0176.52	TE FEMELLE PEXAL 75X1"X75 VS0131343	U	29466.8	294,20

valsir
QUALITY FOR PLUMBING

RACCORD MULTICOUCHE PEXAL
FF - Applique murale



	DÉSIGNATION	UT	CODE	PPHT (€)
376.0007.08	APPLIQUE FEM. PEXAL 16X1/2 VS0171005	U	6342Q.2	11,80
376.0007.58	APPLIQUE FEM. PEXAL 20X1/2 VS0171021	U	6343U.2	12,63

valsir
QUALITY FOR PLUMBING

RACCORD MULTICOUCHE PEXAL
FF - Coudé écrou tournant - Portée plate + joint



	DÉSIGNATION	UT	CODE	PPHT (€)
376.0006.61	COUDE ECR.TOURN.PEXAL 16X1/2" VS0171157	U	63439.4	11,01
376.0007.07	COUDE ECR.TOURN.PEXAL 20X1/2" VS0171167	U	6359U.3	11,78
376.0007.69	COUDE ECR.TOURN.PEXAL 20X3/4" VS0171169	U	6344N.4	12,82
376.0010.09	COUDE ECR.TOURN.PEXAL 26X3/4" VS0171173	U	6344Q.0	16,81
376.0007.43	COUDE ECR.TOURN.PEXAL 16X3/4 VS0171159	U	185QT.0	12,38
376.0005.45	COUDE ECR.TOURN.PEXAL 16X3/8 VS0171155	U	185QV.5	9,08

valsir
QUALITY FOR PLUMBING

RACCORD MULTICOUCHE PEXAL
FF - Droit écrou tournant - Portée plate + joint



	DÉSIGNATION	UT	CODE	PPHT (€)
376.0003.83	RACCORD DRT ECR.TOURN.PEXAL 16X3/8" VS0171113	U	6330E.7	6,39
376.0003.53	RACCORD DRT ECR.TOURN.PEXAL 16X1/2" VS0171107	U	6330R.4	5,88
376.0004.55	RACCORD DRT ECR.TOURN.PEXAL 16X3/4" VS0171111	U	6330W.3	7,58
376.0004.73	RACCORD DRT ECR.TOURN.PEXAL 20X1/2" VS0171117	U	6331H.0	7,89
376.0005.30	RACCORD DRT ECR.TOURN.PEXAL 20X3/4" VS0171119	U	63312.3	8,84
376.0007.96	RACCORD DRT ECR.TOURN.PEXAL 26X3/4" VS0171123	U	6330V.5	13,26
376.0011.94	RACCORD DRT ECR.TOURN.PEXAL 26X1" VS0171125	U	6330M.2	19,90

MULTICOUCHE

RACCORDS MULTICOUCHE A SERTIR ET A VISSER

valsir
QUALITY FOR PLUMBING

RACCORD MULTICOUCHE PEXAL
FF - Droit écrou tournant - Portée
plate + joint
- suite



	DÉSIGNATION	UT	CODE	PPHT (€)
376.0015.92	RACCORD DRT ECR.TOURN.PEXAL 32X1" VS0171131	U	6330P.8	26,53
377.0035.92	RACCORD DRT ECR.TOURN.PEXAL40X1"1/4 VS0131627	U	75836.7	59,86
377.0044.81	RACCORD DRT ECR.TOURN.PEXAL50X1"1/2 VS0131631	U	75875.5	74,69
377.0073.42	RACCORD DRT ECR.TOURN.PEXAL 63X2" VS0131633	U	6905J.3	122,37
377.0130.04	RACCORD DRT ECR.T.PEXAL 75X2"1/2 VS0131635	U	99190.9	216,74
376.0018.56	RACCORD ECROU TOURNANT 32X3 1"1/4 VS0171133	U	1850S.2	30,94

valsir
QUALITY FOR PLUMBING

RACCORD MULTICOUCHE PEXAL
FF - Droit



	DÉSIGNATION	UT	CODE	PPHT (€)
376.0003.30	RACCORD DRT FEM. PEXAL 16X1/2 VS0170305	U	6333Q.3	5,50
376.0005.00	RACCORD DRT FEM. PEXAL 16X3/4 VS0170309	U	6330T.0	8,33
376.0004.71	RACCORD DRT FEM. PEXAL 20X1/2 VS0170321	U	6333P.5	7,85
376.0006.28	RACCORD DRT FEM. PEXAL 20X3/4 VS0170325	U	6334V.1	10,46
376.0009.55	RACCORD DRT FEM. PEXAL 26X1" VS0170331	U	6333T.7	15,91
376.0007.39	RACCORD DRT FEM. PEXAL 26X3/4 VS0170335	U	6333R.1	12,31
376.0011.39	RACCORD DRT FEM. PEXAL 32X1 VS0170339	U	6333S.9	18,99
377.0030.64	RACCORD DRT FEM. PEXAL 40X1"1/2 VS0130729	U	75313.7	51,06
377.0027.20	RACCORD DRT FEM. PEXAL 40X1"1/4 VS0130727	U	75308.7	45,34
377.0034.64	RACCORD DRT FEM. PEXAL 50X1"1/2 VS0130733	U	67955.5	57,74
377.0057.21	RACCORD DRT FEM. PEXAL 63X2" VS0130739	U	89995.5	95,35

valsir
QUALITY FOR PLUMBING

RACCORD MULTICOUCHE PEXAL
MF - Droit



	DÉSIGNATION	UT	CODE	PPHT (€)
376.0002.84	RACCORD DRT MALE PEXAL 16X1/2 VS0170205	U	63339.6	4,73
376.0004.50	RACCORD DRT MALE PEXAL 16X3/4 VS0170209	U	6331Q.5	7,50
376.0003.29	RACCORD DRT MALE PEXAL 16X3/8 VS0170213	U	6329X.4	5,48
376.0003.58	RACCORD DRT MALE PEXAL 20X1/2 VS0170221	U	6343R.9	5,96
376.0004.37	RACCORD DRT MALE PEXAL 20X3/4 VS0170225	U	6332T.8	7,28
376.0008.76	RACCORD DRT MALE PEXAL 26X1" VS0170231	U	7028V.0	14,60
376.0007.23	RACCORD DRT MALE PEXAL 26X1/2" VS0170233	U	6343W.8	12,05
376.0006.40	RACCORD DRT MALE PEXAL 26X3/4" VS0170235	U	6333X.8	10,66
376.0009.35	RACCORD DRT MALE PEXAL 32X1" VS0170239	U	6333U.4	15,59
377.0022.37	RACCORD DRT MALE PEXAL 40X1"1/4 VS0130627	U	89911.2	37,29
377.0031.46	RACCORD DRT MALE PEXAL 50X1"1/2 VS0130633	U	67946.4	52,44
377.0052.30	RACCORD DRT MALE PEXAL 63X2" VS0130639	U	89921.1	87,16
377.0105.01	RACCORD DRT MALE PEXAL 75X2X1/2 VS0130643	U	29460.3	175,02
376.0016.32	RACCORD DRT MALE PEXAL 32X1"1/4 VS0170241	U	191RD.7	27,20

MULTICOUCHE

RACCORDS MULTICOUCHE A SERTIR ET A VISSER

valsir
QUALITY FOR PLUMBING

BOUCHON MULTICOUCHE PEXAL

Mâle - Protection de raccords de mise à l'essai de
l'installation - Bleu



	DÉSIGNATION	UT	CODE	PPHT (€)
759.0001.58	BOUCHON FILETE BLEU PEXAL 1/2" VS0825051	U	9667G.0	2,63

valsir
QUALITY FOR PLUMBING

BOUCHON MULTICOUCHE PEXAL

Mâle - Protection de raccords de mise à l'essai de
l'installation - Rouge



	DÉSIGNATION	UT	CODE	PPHT (€)
759.0001.58	BOUCHON FILETE ROUGE PEXAL 1/2" VS0825053	U	9668D.6	2,63

Pour plus d'infos,
consultez
le CAHIER TECHNIQUE
page 14

PER

TUBES PER



TUBE PER
Nu - Bleu



	DÉSIGNATION	UT	CODE	PPHT (€)
275.0162.35	TUBE PER NU 16X20 C120M BLEU	U	213C0.6	324,71



TUBE PER
Nu - Rouge



	DÉSIGNATION	UT	CODE	PPHT (€)
275.0028.75	TUBE PER NU 10X12 C120M ROUGE	U	213BW.2	57,49



TUBE PER
Prégainé - Bleu



	DÉSIGNATION	UT	CODE	PPHT (€)
275.0063.69	TUBE PER PREGAINE SPL.10X12 C100M BLEU	U	213CB.2	127,39



TUBE PER
Pré-gainé simple - Bleu



	DÉSIGNATION	UT	CODE	PPHT (€)	ECOPART (€)
275.0071.96	TUBE PER PREG.SPL.10X12 C.25M BLEU PERPB1225	U	0492G.0	86,75	0,05
275.0093.96	TUBE PER PREG.SPL.13X16 C.25M BLEU PERPB1625	U	0492J.5	113,29	0,08



TUBE PER
Pré-gainé simple - Rouge



	DÉSIGNATION	UT	CODE	PPHT (€)	ECOPART (€)
275.0069.86	TUBE PER PREG.SPL.10X12 C.25M ROUGE PERPR1225	U	0492I.6	84,22	0,05
275.0093.96	TUBE PER PREG.SPL.13X16 C.25M ROUGE PERPR1625	U	0492K.3	113,29	0,08

Le PPHT comprend l'ecopart (€)

PER

TUBES PER



TUBE RAUTHERM RAU-PER -PE
Nu - Rouge - Avec barrière anti-oxygène (BAO) - En Couronne



	DÉSIGNATION	UT	CODE	PPHT (€)	ECOPART (€)
000.0210.80	TUBE PER 16X1,5 BAO C100M RGE 11364301103	U	321TX.9	248,01	0,01
000.0295.12	TUBE PER 16X1,5 BAO C140M RGE 11364301143	U	321TV.3	347,21	0,01
000.0505.92	TUBE PER 16X1,5 BAO C240M RGE 11364301243	U	321TR.2	595,21	0,01



TUBE RAUTHERM SPEED- PE-XA
Avec B.A.O



	DÉSIGNATION	UT	CODE	PPHT (€)	ECOPART (€)
000.1351.50	TUBE PER SPEED BAO 16X1,5 C500M 11604501500	U	321TN.8	1590,01	0,01

RACCORDS PER A SERTIR



EXCLUSIVITES RICHARDSON PAR ANQUIER

Platine de fixation - à sertir



	DÉSIGNATION	UT	CODE	PPHT (€)
000.0027.95	PLATINE FIXATION DN16 PER SERTIR TEKNIK 1923	U	307Z0.9	43,00

ROBIFIX
ROBIFIX

Kit conçu pour la fixation de robinetterie sur cloison de plâtre - Robifix à souder - Entraxe 150 mm



	DÉSIGNATION	UT	CODE	PPHT (€)	ECOPART (€)
276.0078.09	ROBIFIX 150MM F1/2 CU D.14 009121	U	9051B.5	104,13	0,01

ROBIFIX
ROBIFIX
Cache



	DÉSIGNATION	UT	CODE	PPHT (€)	ECOPART (€)
276.0058.20	CACHE ROBIFIX ENTRAXE 150MM 008848	U	4470D.5	77,61	0,01
276.0028.31	CACHE ROBIFIX MONDROU 008849	U	4470E.2	37,76	0,01

PER

RACCORDS PER A SERTIR



COUDE
Egal



	DÉSIGNATION	UT	CODE	PPHT (€)	ECOPART (€)
276.0006.51	COUDE EGAL A SERTIR 16 RIOQUIER 17121	U	91841.7	8,69	0,01
276.0008.42	COUDE EGAL A SERTIR 20 RIOQUIER 17122	U	92129.6	11,24	0,01



TE
Egal



	DÉSIGNATION	UT	CODE	PPHT (€)	ECOPART (€)
276.0009.26	TE EGAL A SERTIR 16-16-16 RIOQUIER 17161	U	91937.3	12,35	0,01
276.0011.28	TE EGAL A SERTIR 20-20-20 RIOQUIER 17162	U	89211.7	15,05	0,01



UNION
Egal



	DÉSIGNATION	UT	CODE	PPHT (€)	ECOPART (€)
276.0004.15	UNION EGALE A SERTIR 12 RIOQUIER 17050	U	91267.5	4,16	0,01
276.0004.07	UNION EGALE A SERTIR 16 RIOQUIER 17051	U	91293.1	5,44	0,01
276.0005.86	UNION EGALE A SERTIR 20 RIOQUIER 17052	U	91302.0	7,83	0,01

RACCORDS PER A SERTIR ET A VISSER



COUDE
Coude Femelle à sertir



	DÉSIGNATION	UT	CODE	PPHT (€)	ECOPART (€)
276.0007.48	COUDE FEM.A SERT.16-1/2 RIOQUIER 17103	U	91770.8	9,99	0,01



COUDE
Coude à écrou tournant



	DÉSIGNATION	UT	CODE	PPHT (€)	ECOPART (€)
276.0010.78	COUDE ECROU LIBRE A SERT.16-1/2 RIOQUIER 17083	U	91658.5	14,39	0,01

PER

RACCORDS PER A SERTIR ET A VISSER



TE
Té Femelle



	DÉSIGNATION	UT	CODE	PPHT (€)	ECOPART (€)
276.0010.84	TE A SERTIR F.16-1/2-16 RIOQUIER 17151	U	2027K.3	14,47	0,01



RACCORD
Droit - Ecrou libre Femelle



	DÉSIGNATION	UT	CODE	PPHT (€)	ECOPART (€)
276.0002.97	ECROU LIBRE A SERT.F.12-1/2 RIOQUIER 17001	U	91175.0	3,97	0,01
276.0004.12	ECROU LIBRE A SERT.F.16-3/8 RIOQUIER 17002	U	2997B.7	5,51	0,01
276.0003.50	ECROU LIBRE A SERT.F.16-1/2 RIOQUIER 17003	U	91181.8	4,68	0,01
276.0004.87	ECROU LIBRE A SERT.F.16-3/4 RIOQUIER 17004	U	91200.6	6,50	0,01
276.0005.59	ECROU LIBRE A SERT.F.20-3/4 RIOQUIER 17006	U	91220.4	7,46	0,01



RACCORD
Droit - Mâle fixe



	DÉSIGNATION	UT	CODE	PPHT (€)	ECOPART (€)
276.0003.11	RACCORD MALE FIXE A SERT.12-3/8 RIOQUIER 17020	U	91225.3	4,16	0,01
276.0003.67	RACCORD MALE FIXE A SERT.16-3/8 RIOQUIER 17022	U	91242.8	4,90	0,01
276.0004.11	RACCORD MALE FIXE A SERT.16-1/2 RIOQUIER 17023	U	91251.9	5,49	0,01
276.0007.85	RACCORD MALE FIXE A SERT.20-3/4 RIOQUIER 17026	U	91263.4	10,48	0,01



RACCORD
Droit - Femelle fixe



	DÉSIGNATION	UT	CODE	PPHT (€)	ECOPART (€)
276.0004.96	RACCORD FIXE A SERTIR F.16-1/2 RIOQUIER 17013	U	5153B.0	6,62	0,01

RACCORDS PER A GLISSEMENT



EXCLUSIVITES RICHARDSON PAR ANQUIER

Platine de fixation - à glissement

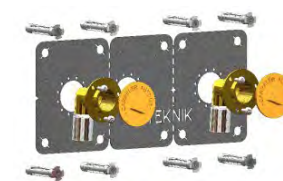

	DÉSIGNATION	UT	CODE	PPHT (€)
000.0026.66	PLATINE FIXATION DN16 PER GLISS. TEKNIK 1921	U	30722.5	43,00

Le PPHT comprend l'ecopart (€)

PER

RACCORDS PER A GLISSEMENT



COUDE
Egal



	DÉSIGNATION	UT	CODE	PPHT (€)	ECOPART (€)
276.0006.65	COUDE EGAL A GLIS.12 P.PER RIQUEIR 16180	U	36284.8	8,88	0,01
276.0005.48	COUDE EGAL A GLIS.16 P.PER RIQUEIR 16181	U	52093.2	7,31	0,01
276.0006.62	COUDE EGAL A GLIS.20 P.PER RIQUEIR 16182	U	36285.5	8,83	0,01
276.0013.28	COUDE EGAL A GLIS.25 P.PER RIQUEIR 16183	U	0653E.9	17,71	0,01



TE
Egal



	DÉSIGNATION	UT	CODE	PPHT (€)	ECOPART (€)
276.0007.32	TE EGAL A GLISS.12-12-12 P.PER RIQUEIR 16070	U	36297.0	9,77	0,01
276.0007.30	TE EGAL A GLISS.16-16-16 P.PER RIQUEIR 16071	U	52148.4	9,74	0,01
276.0009.04	TE EGAL A GLISS.20-20-20 P.PER RIQUEIR 16072	U	36300.2	12,06	0,01



TE
Réduit



	DÉSIGNATION	UT	CODE	PPHT (€)	ECOPART (€)
276.0009.38	TE INEGAL A GLIS.16-12-16 P.PER RIQUEIR 16081	U	5526L.0	12,52	0,01
276.0009.58	TE INEGAL A GLIS.20-16-20 P.PER RIQUEIR 16089	U	6877A.5	12,79	0,01



UNION
Egal



	DÉSIGNATION	UT	CODE	PPHT (€)	ECOPART (€)
276.0002.90	UNION EGALE A GLIS.12 P.PER RIQUEIR 16110	U	36267.3	3,87	0,01
276.0003.40	UNION EGALE A GLIS.16 P.PER RIQUEIR 16111	U	52174.0	4,55	0,01
276.0005.07	UNION EGALE A GLIS.20 P.PER RIQUEIR 16112	U	36268.1	6,77	0,01
276.0011.87	UNION EGALE A GLIS.25 P.PER RIQUEIR 16113	U	12815.7	15,84	0,01



UNION
Réduit



	DÉSIGNATION	UT	CODE	PPHT (€)	ECOPART (€)
276.0005.01	UNION INEGALE A GLIS.12-16 PER RIQUEIR 16120	U	36270.7	6,69	0,01
276.0006.41	UNION INEGALE A GLIS.16-20 PER RIQUEIR 16122	U	52059.3	8,56	0,01

Le PPHT comprend l'ecopart (€)

PER

RACCORDS PER A GLISSEMENT



UNION
PER-CUIVRE



	DÉSIGNATION	UT	CODE	PPHT (€)	ECOPART (€)
276.0003.02	UNION A GLIS.PER 16 CUIVRE 14 RIQUEIR 16201	U	99939.1	4,04	0,01
276.0003.02	UNION A GLIS.PER 16 CUIVRE 16 RIQUEIR 16202	U	96460.1	4,04	0,01



ROBIFIX
Kit conçu pour la fixation de robinetterie sur cloison en plaque de plâtre - Mono



	DÉSIGNATION	UT	CODE	PPHT (€)	ECOPART (€)
276.0049.40	ROBIFIX MONO F1/2 RAC.GLIS.PER.D.16 008834	U	1254A.9	65,87	0,01



ROBIFIX
Kit conçu pour la fixation de robinetterie sur cloison en plaque de plâtre - Entraxe 60 mm



	DÉSIGNATION	UT	CODE	PPHT (€)	ECOPART (€)
276.0104.12	ROBIFIX ENTRAXE 50MM M3/8 R.GLIS.PER 16008885	U	88058.3	104,13	0,01

RACCORDS PER A GLISSEMENT ET A VISSER



COUDE
Femelle - Femelle



	DÉSIGNATION	UT	CODE	PPHT (€)	ECOPART (€)
276.0006.10	COUDE FEM.A GLIS.PER 12-1/2 RIQUEIR 16161	U	36277.2	8,14	0,01
276.0006.28	COUDE FEM.A GLIS.PER 16-1/2 RIQUEIR 16163	U	36279.8	8,39	0,01



COUDE
Mâle - Mâle



	DÉSIGNATION	UT	CODE	PPHT (€)	ECOPART (€)
276.0006.80	COUDE MALE A GLIS.PER 12-3/8 RIQUEIR 16170	U	36283.0	9,08	0,01
276.0009.86	COUDE MALE A GLIS.PER 16-3/8 RIQUEIR 16172	U	20449.5	13,16	0,01
276.0007.16	COUDE MALE A GLIS.PER 16-1/2 RIQUEIR 16173	U	19984.4	9,55	0,01
276.0008.36	COUDE MALE A GLIS.PER 20-1/2 RIQUEIR 16174	U	20066.7	11,15	0,01

PER

RACCORDS PER A GLISSEMENT ET A VISSER



COUDE

Avec Applique - Avec applique



	DÉSIGNATION	UT	CODE	PPHT (€)	ECOPART (€)
276.0007.52	COUDE APPLIQ.A GLIS.PER 16-1/2 RIOQUIER 16141	U	19608.9	10,04	0,01
276.0011.58	COUDE APPLIQ.LONG A GLIS.16-1/2 RIOQUIER 16151	U	09481.3	15,45	0,01



COUDE

A écrou tournant - A écrou tournant



	DÉSIGNATION	UT	CODE	PPHT (€)	ECOPART (€)
276.0011.80	COUDE EC.TOURN.GLIS.PER 12-1/2 RIOQUIER 16130	U	19582.6	15,75	0,01
276.0011.80	COUDE EC.TOURN.GLIS.PER 16-1/2 RIOQUIER 16131	U	19583.4	15,75	0,01
276.0022.35	COUDE EC.TOURN.GLIS.PER 16-3/4 RIOQUIER 16134	U	82976.2	29,81	0,01
276.0016.34	COUDE EC.TOURN.GLIS.PER 20-1/2 RIOQUIER 16132	U	19591.7	21,79	0,01
276.0020.49	COUDE EC.TOURN.GLIS.PER 20-3/4 RIOQUIER 16136	U	5956E.2	27,33	0,01
276.0025.54	COUDE EC.TOURN.GLIS.PER 25-3/4 RIOQUIER 16133	U	19602.2	34,06	0,01



TE

Femelle - Femelle



	DÉSIGNATION	UT	CODE	PPHT (€)	ECOPART (€)
276.0010.03	TE A GLISS.F.16-1/2-16 PER RIOQUIER 16051	U	8486C.0	13,38	0,01



ECROU

EcroU Femelle Fixe - Ecrou Femelle fixe



	DÉSIGNATION	UT	CODE	PPHT (€)	ECOPART (€)
276.0004.24	ECROU FIXE A GLISS.PER F.12-1/2 RIOQUIER 16011	U	45353.0	5,66	0,01
276.0005.18	ECROU FIXE A GLISS.PER F.16-3/8 RIOQUIER 16012	U	5527F.0	6,92	0,01
276.0004.28	ECROU FIXE A GLISS.PER F.16-1/2 RIOQUIER 16013	U	0884A.9	5,71	0,01
276.0007.13	ECROU FIXE A GLISS.PER F.20-3/4 RIOQUIER 16015	U	1558F.1	9,52	0,01



ECROU

EcroU Mâle Fixe - Ecrou Mâle fixe



	DÉSIGNATION	UT	CODE	PPHT (€)	ECOPART (€)
276.0002.60	RACCORD FIXE MALE A GLIS.12-3/8 RIOQUIER 16020	U	36263.2	3,47	0,01
276.0002.90	RACCORD FIXE MALE A GLIS.12-1/2 RIOQUIER 16021	U	19739.2	3,87	0,01
276.0002.95	RACCORD FIXE MALE A GLIS.16-1/2 RIOQUIER 16023	U	19780.6	3,94	0,01
276.0005.31	RACCORD FIXE MALE A GLIS.16-3/4 RIOQUIER 16024	U	36265.7	7,09	0,01
276.0002.63	RACCORD FIXE MALE A GLIS.16-3/8 RIOQUIER 16022	U	4540F.6	3,52	0,01

PER

RACCORDS PER A GLISSEMENT ET A VISSER



ECROU

EcroU Mâle Fixe - Ecrou Mâle fixe - suite



	DÉSIGNATION	UT	CODE	PPHT (€)	ECOPART (€)
276.0003.94	RACCORD FIXE MALE A GLIS.20-1/2 RIOQUIER 16025	U	19790.5	5,27	0,01
276.0006.21	RACCORD FIXE MALE A GLIS.20-3/4 RIOQUIER 16026	U	91109.9	8,29	0,01
276.0008.99	RACCORD FIXE MALE A GLIS.25-3/4 RIOQUIER 16028	U	91155.2	12,00	0,01



ECROU

EcroU Tournant Femelle - Ecrou tournant Femelle



	DÉSIGNATION	UT	CODE	PPHT (€)	ECOPART (€)
276.0002.19	ECROU TOURNANT A GLIS.F.12-3/8 RIOQUIER 16000	U	36313.5	2,93	0,01
276.0002.52	ECROU TOURNANT A GLIS.F.12-1/2 RIOQUIER 16001	U	19615.4	3,37	0,01
276.0002.84	ECROU TOURNANT A GLIS.F.16-3/8 RIOQUIER 16002	U	91076.0	3,79	0,01
276.0001.68	ECROU TOURNANT A GLIS.F.16-1/2 RIOQUIER 16003	U	19697.2	3,37	0,01
276.0004.00	ECROU TOURNANT A GLIS.F.16-3/4 RIOQUIER 16004	U	36260.8	5,34	0,01
276.0003.22	ECROU TOURNANT A GLIS.F.20-1/2 RIOQUIER 16005	U	19704.6	4,31	0,01
276.0004.31	ECROU TOURNANT A GLIS.F.20-3/4 RIOQUIER 16006	U	36307.7	5,76	0,01
276.0007.00	ECROU TOURNANT A GLIS.F.25-3/4 RIOQUIER 16007	U	81485.5	9,35	0,01
276.0012.63	ECROU TOURNANT A GLIS.F.25-1 RIOQUIER 16008	U	13751.6	16,85	0,01

Pour plus d'infos,
consultez
le CAHIER TECHNIQUE
page 14

CUIVRE ET LAITON

TUBES CUIVRE

TUBE ECROUI
 EN 1057 - Barre

	DÉSIGNATION	UT	CODE	PPHT (€)
140.0018.65	TUBE CUIVRE ECROUI LONG 2.50M 10X12	U	47316.5	31,09
140.0018.70	TUBE CUIVRE ECROUI LONG 2.50M 12X14	U	47317.3	31,16
140.0021.73	TUBE CUIVRE ECROUI LONG 2.50M 14X16	U	47318.1	36,21
140.0025.30	TUBE CUIVRE ECROUI LONG 2.50M 16X18	U	47319.9	42,16
140.0029.69	TUBE CUIVRE ECROUI LONG 2.50M 20X22	U	47321.5	49,49
140.0041.20	TUBE CUIVRE ECROUI LONG 2.50M 26X28	U	8949K.5	68,66

TUBE ECROUI DUR
 EN 1057 - Barre - Anticorrosion

	DÉSIGNATION	UT	CODE	PPHT (€)
140.0002.59	TUBE CUIVRE ECROUI ANTICOR. -L65M- 8X1.00	M	00879.7	4,32
140.0005.08	TUBE CUIVRE ECROUI ANTICOR. -L65M- 10X1.00	M	00880.5	8,46
140.0005.86	TUBE CUIVRE ECROUI ANTICOR. -L65M- 12X1.00	M	00881.3	9,76
140.0006.64	TUBE CUIVRE ECROUI ANTICOR. -L65M- 14X1.00	M	00882.1	11,07
140.0007.22	TUBE CUIVRE ECROUI ANTICOR. -L65M- 16X1.00	M	00884.7	12,03
140.0009.63	TUBE CUIVRE ECROUI ANTICOR. -L65M- 18X1.00	M	00885.4	16,05
140.0010.90	TUBE CUIVRE ECROUI ANTICOR. -L65M- 22X1.00	M	00887.0	18,17
140.0013.57	TUBE CUIVRE ECROUI ANTICOR. -L65M- 28X1.00	M	00897.9	22,61
140.0016.96	TUBE CUIVRE ECROUI ANTICOR. -L65M- 32X1.00	M	00901.9	28,26
140.0018.91	TUBE CUIVRE ECROUI ANTICOR. -L65M- 35X1.00	M	00906.8	31,51
140.0018.85	TUBE CUIVRE ECROUI ANTICOR. -L65M- 40X1.00	M	00910.0	31,41
140.0024.31	TUBE CUIVRE ECROUI ANTICOR. -L65M- 42X1.00	M	00912.6	40,51
140.0027.74	TUBE CUIVRE ECROUI ANTICOR. -L65M- 52X1.00	M	00915.9	46,24
140.0032.60	TUBE CUIVRE ECROUI ANTICOR. -L65M- 54X1.00	M	00916.7	54,34
140.0025.58	TUBE CUIVRE ECROUI ANTICOR. -L65M- 54X1.50	M	01409.2	42,63

TUBE RECUIT
 Nu - EN 1057 - Couronne



	DÉSIGNATION	UT	CODE	PPHT (€)
140.0021.51	TUBE CUIVRE RECUIT -COUR.5M- 8X1.00	U	48214.1	35,85
140.0034.87	TUBE CUIVRE RECUIT -COUR.5M- 10X1.00	U	25630.5	58,11
140.0065.46	TUBE CUIVRE RECUIT -COUR.10M-10X1.00	U	74536.4	109,10
140.0039.46	TUBE CUIVRE RECUIT -COUR.5M- 12X1.00	U	09791.5	65,77
140.0080.18	TUBE CUIVRE RECUIT -COUR.10M-12X1.00	U	09792.3	133,63
140.0042.29	TUBE CUIVRE RECUIT -COUR.5M- 14X1.00	U	40255.2	70,49
140.0085.75	TUBE CUIVRE RECUIT -COUR.10M-14X1.00	U	40253.7	142,91
140.0070.40	TUBE CUIVRE RECUIT -COUR.5M- 16X1.00	U	40256.0	117,33
140.0089.90	TUBE CUIVRE RECUIT -COUR.10M-16X1.00	U	40254.5	149,84

CUIVRE ET LAITON

TUBES CUIVRE

TUBE RECUIT
 Nu - EN 1057 - Couronne - Anticorrosion

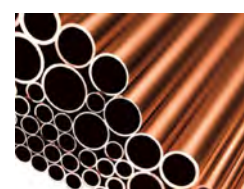
	DÉSIGNATION	UT	CODE	PPHT (€)
140.0004.81	TUBE CUIVRE RECUIT ANTICOR. -C50M- 10X1.00	M	00814.4	8,01
140.0005.53	TUBE CUIVRE RECUIT ANTICOR. -C50M- 12X1.00	M	00827.6	9,21
140.0007.40	TUBE CUIVRE RECUIT ANTICOR. -C50M- 14X1.00	M	00856.5	12,33
140.0008.30	TUBE CUIVRE RECUIT ANTICOR. -C50M- 15X1.00	M	41352.6	13,83
140.0007.74	TUBE CUIVRE RECUIT ANTICOR. -C50M- 16X1.00	M	00860.7	12,90
140.0008.19	TUBE CUIVRE RECUIT ANTICOR. -C35M- 18X1.00	M	00861.5	13,65
140.0011.27	TUBE CUIVRE RECUIT ANTICOR. -C35M- 22X1.00	M	00875.5	18,78

SANCO®
TUBE ECROUI DEMI-DUR SANCO
 EN 1057 - Barre

	DÉSIGNATION	UT	CODE	PPHT (€)
140.0005.48	TUBE CUIVRE SANCO DROIT DEMI DUR 5M 12X1.00	M	37071.8	9,14
140.0006.86	TUBE CUIVRE SANCO DROIT DEMI DUR 5M 14X1.00	M	37072.6	11,44
140.0007.64	TUBE CUIVRE SANCO DROIT DEMI DUR 5M 15X1.00	M	7009B.2	12,74
140.0007.20	TUBE CUIVRE SANCO DROIT DEMI DUR 5M 16X1.00	M	37069.2	12,00
140.0007.75	TUBE CUIVRE SANCO DROIT DEMI DUR 5M 18X1.00	M	37073.4	12,92
140.0009.70	TUBE CUIVRE SANCO DROIT DEMI DUR 5M 22X1.00	M	37075.9	16,16

RACCORDS CUIVRE A SOUDER

COUDE SERIE PRESSION
 MF - 90° - Petit rayon - 92Cu - EN 1254-1

	DÉSIGNATION	UT	CODE	PPHT (€)
374.0004.49	COUDE 90.PR MF PRESSION A SOUDER 92CU 10	U	24579.5	5,99
374.0002.18	COUDE 90.PR MF PRESSION A SOUDER 92CU 12	U	24580.3	2,91
374.0002.00	COUDE 90.PR MF PRESSION A SOUDER 92CU 14	U	24600.9	2,67
374.0002.24	COUDE 90.PR MF PRESSION A SOUDER 92CU 16	U	24589.4	2,98
374.0002.36	COUDE 90.PR MF PRESSION A SOUDER 92CU 18	U	24590.2	3,15
374.0004.17	COUDE 90.PR MF PRESSION A SOUDER 92CU 22	U	24582.9	5,56
374.0006.17	COUDE 90.PR MF PRESSION A SOUDER 92CU 28	U	24594.4	8,23
374.0009.80	COUDE 90.PR MF PRESSION A SOUDER 92CU 32	U	24595.1	13,06
374.0015.32	COUDE 90.PR MF PRESSION A SOUDER 92CU 40	U	24597.7	20,42
374.0028.67	COUDE 90.PR MF PRESSION A SOUDER 92CU 42	U	24598.5	38,23

CUIVRE ET LAITON

RACCORDS CUIVRE A SOUDER



COUDE SERIE PRESSION

FF - 90° - Petit rayon - 90Cu - EN 1254-1



	DÉSIGNATION	UT	CODE	PPHT (€)
374.0002.84	COUDE 90.PR FF PRESSION A SOUDER 90CU 10	U	05315.7	3,79
374.0001.03	COUDE 90.PR FF PRESSION A SOUDER 90CU 12	U	05316.5	1,37
374.0001.08	COUDE 90.PR FF PRESSION A SOUDER 90CU 14	U	05317.3	1,44
374.0001.35	COUDE 90.PR FF PRESSION A SOUDER 90CU 16	U	05318.1	1,80
374.0001.49	COUDE 90.PR FF PRESSION A SOUDER 90CU 18	U	05319.9	1,99
374.0002.38	COUDE 90.PR FF PRESSION A SOUDER 90CU 22	U	05321.5	3,17
374.0003.99	COUDE 90.PR FF PRESSION A SOUDER 90CU 28	U	05322.3	5,32
374.0009.30	COUDE 90.PR FF PRESSION A SOUDER 90CU 32	U	24591.0	12,40
374.0015.02	COUDE 90.PR FF PRESSION A SOUDER 90CU 35	U	79352.1	20,02
374.0013.10	COUDE 90.PR FF PRESSION A SOUDER 90CU 40	U	24593.6	17,46
374.0023.94	COUDE 90.PR FF PRESSION A SOUDER 90CU 42	U	05324.9	31,92
374.0040.66	COUDE 90.PR FF PRESSION A SOUDER 90CU 52	U	24577.9	54,21
374.0047.02	COUDE 90.PR FF PRESSION A SOUDER 90CU 54	U	79360.4	62,70



COURBE SERIE PRESSION

MF - 45° - Grand rayon - 40Cu/5040 - EN 1254-1



	DÉSIGNATION	UT	CODE	PPHT (€)
374.0002.47	COURBE 45 GR MF PRESSION A SOUDER 40CU 12	U	05301.7	3,29
374.0002.73	COURBE 45 GR MF PRESSION A SOUDER 40CU 14	U	05302.5	3,64
374.0003.85	COURBE 45 GR MF PRESSION A SOUDER 40CU 16	U	05303.3	5,13
374.0003.04	COURBE 45 GR MF PRESSION A SOUDER 40CU 18	U	05304.1	4,05
374.0002.98	COURBE 45 GR MF PRESSION A SOUDER 40CU 22	U	00305.3	3,97
374.0005.39	COURBE 45 GR MF PRESSION A SOUDER 40CU 28	U	24332.9	7,19
374.0008.30	COURBE 45 GR MF PRESSION A SOUDER 40CU 32	U	05305.8	11,07
374.0018.90	COURBE 45 GR MF PRESSION A SOUDER 40CU 35	U	79354.7	25,20
374.0018.86	COURBE 45 GR MF PRESSION A SOUDER 40CU 42	U	24331.1	25,15
374.0039.80	COURBE 45 GR MF PRESSION A SOUDER 40CU 52	U	26417.6	53,07



COURBE SERIE PRESSION

FF - 45° - Grand rayon - 41Cu/5041 - EN 1254-1



	DÉSIGNATION	UT	CODE	PPHT (€)
374.0003.39	COURBE 45 GR FF PRESSION A SOUDER 41CU 12	U	05307.4	4,52
374.0002.31	COURBE 45 GR FF PRESSION A SOUDER 41CU 14	U	05308.2	3,08
374.0002.59	COURBE 45 GR FF PRESSION A SOUDER 41CU 16	U	05309.0	3,45
374.0002.54	COURBE 45 GR FF PRESSION A SOUDER 41CU 18	U	05310.8	3,38
374.0003.07	COURBE 45 GR FF PRESSION A SOUDER 41CU 22	U	05312.4	4,09
374.0005.22	COURBE 45 GR FF PRESSION A SOUDER 41CU 28	U	05313.2	6,96
374.0008.20	COURBE 45 GR FF PRESSION A SOUDER 41CU 32	U	24583.7	10,93
374.0017.26	COURBE 45 GR FF PRESSION A SOUDER 41CU 35	U	79355.4	23,02
374.0010.96	COURBE 45 GR FF PRESSION A SOUDER 41CU 40	U	24586.0	14,62

CUIVRE ET LAITON

RACCORDS CUIVRE A SOUDER



COURBE SERIE PRESSION

FF - 45° - Grand rayon - 41Cu/5041 - EN 1254-1 - suite



	DÉSIGNATION	UT	CODE	PPHT (€)
374.0027.61	COURBE 45 GR FF PRESSION A SOUDER 41CU 42	U	24587.8	36,81
374.0038.08	COURBE 45 GR FF PRESSION A SOUDER 41CU 52	U	24588.6	50,77
374.0055.22	COURBE 45 GR FF PRESSION A SOUDER 41CU 54	U	79363.8	73,63



COURBE SERIE PRESSION

MF - 90° - Grand rayon - 1aCu/5001 - EN 1254-1



	DÉSIGNATION	UT	CODE	PPHT (€)
374.0001.90	COURBE 90 GR MF PRESSION A SOUDER 1ACU 12	U	05285.2	2,53
374.0002.27	COURBE 90 GR MF PRESSION A SOUDER 1ACU 14	U	05286.0	3,03
374.0002.22	COURBE 90 GR MF PRESSION A SOUDER 1ACU 16	U	05287.8	2,96
374.0002.52	COURBE 90 GR MF PRESSION A SOUDER 1ACU 18	U	05291.0	3,36
374.0002.91	COURBE 90 GR MF PRESSION A SOUDER 1ACU 22	U	05288.6	3,88
374.0008.14	COURBE 90 GR MF PRESSION A SOUDER 1ACU 28	U	05289.4	10,86



COURBE SERIE PRESSION

FF - 90° - Grand rayon - 2aCu/5002 - EN 1254-1



	DÉSIGNATION	UT	CODE	PPHT (€)
374.0001.16	COURBE 90 GR FF PRESSION A SOUDER 2ACU 12	U	05293.6	1,54
374.0001.76	COURBE 90 GR FF PRESSION A SOUDER 2ACU 14	U	05294.4	2,34
374.0002.12	COURBE 90 GR FF PRESSION A SOUDER 2ACU 16	U	05295.1	2,82
374.0001.79	COURBE 90 GR FF PRESSION A SOUDER 2ACU 18	U	05296.9	2,39
374.0002.68	COURBE 90 GR FF PRESSION A SOUDER 2ACU 22	U	05298.5	3,57
374.0004.40	COURBE 90 GR FF PRESSION A SOUDER 2ACU 28	U	05299.3	5,87



TE SERIE PRESSION

FFF - Egal - 130Cu - EN 1254-1



	DÉSIGNATION	UT	CODE	PPHT (€)
374.0004.42	TE PRESSION A SOUDER 130CU 10	U	05342.1	5,89
374.0002.27	TE PRESSION A SOUDER 130CU 12	U	05343.9	3,03
374.0002.02	TE PRESSION A SOUDER 130CU 14	U	05344.7	2,70
374.0002.36	TE PRESSION A SOUDER 130CU 16	U	05345.4	3,15
374.0003.18	TE PRESSION A SOUDER 130CU 18	U	05346.2	4,24
374.0004.88	TE PRESSION A SOUDER 130CU 22	U	05348.8	6,51
374.0008.98	TE PRESSION A SOUDER 130CU 28	U	05349.6	11,97

CUIVRE ET LAITON

RACCORDS CUIVRE A SOUDER



TE SERIE PRESSION

FFF - Egal - 130Cu - EN 1254-1
- suite



	DÉSIGNATION	UT	CODE	PPHT (€)
374.0023.86	TE PRESSION A SOUDER 130CU 32	U	05350.4	31,82
374.0022.24	TE PRESSION A SOUDER 130CU 35	U	79358.8	29,65
374.0044.52	TE PRESSION A SOUDER 130CU 40	U	26969.6	59,36
374.0042.58	TE PRESSION A SOUDER 130CU 42	U	26885.4	56,78
374.0119.74	TE PRESSION A SOUDER 130CU 52	U	75694.0	159,66
374.0070.38	TE PRESSION A SOUDER 130CU 54	U	79366.1	93,84



TE SERIE PRESSION

FFF - Réduit - 130Cu - EN 1254-1



	DÉSIGNATION	UT	CODE	PPHT (€)
374.0008.64	TE REDUIT PRESSION A SOUDER 130CU 12X10X12	U	05355.3	11,52
374.0009.47	TE REDUIT PRESSION A SOUDER 130CU 12X14X12	U	05357.9	12,63
374.0003.48	TE REDUIT PRESSION A SOUDER 130CU 14X12X14	U	05363.7	4,64
374.0009.37	TE REDUIT PRESSION A SOUDER 130CU 14X16X14	U	05365.2	12,49
374.0008.21	TE REDUIT PRESSION A SOUDER 130CU 16X12X14	U	05368.6	10,95
374.0005.18	TE REDUIT PRESSION A SOUDER 130CU 16X12X16	U	05369.4	6,91
374.0004.95	TE REDUIT PRESSION A SOUDER 130CU 16X14X14	U	05371.0	6,60
374.0002.96	TE REDUIT PRESSION A SOUDER 130CU 16X14X16	U	05372.8	3,95
374.0011.52	TE REDUIT PRESSION A SOUDER 130CU 16X16X12	U	05373.6	15,36
374.0005.18	TE REDUIT PRESSION A SOUDER 130CU 16X16X14	U	05374.4	6,91
374.0016.91	TE REDUIT PRESSION A SOUDER 130CU 16X18X16	U	05377.7	22,55
374.0005.39	TE REDUIT PRESSION A SOUDER 130CU 18X12X18	U	05381.9	7,19
374.0011.14	TE REDUIT PRESSION A SOUDER 130CU 18X14X14	U	05383.5	14,86
374.0004.35	TE REDUIT PRESSION A SOUDER 130CU 18X14X18	U	05385.0	5,80
374.0011.44	TE REDUIT PRESSION A SOUDER 130CU 18X16X16	U	05387.6	15,26
374.0008.52	TE REDUIT PRESSION A SOUDER 130CU 18X16X18	U	05388.4	11,36
374.0010.29	TE REDUIT PRESSION A SOUDER 130CU 18X18X14	U	05390.0	13,72
374.0011.18	TE REDUIT PRESSION A SOUDER 130CU 18X18X16	U	05391.8	14,91
374.0011.82	TE REDUIT PRESSION A SOUDER 130CU 22X12X22	U	05400.7	15,76
374.0018.94	TE REDUIT PRESSION A SOUDER 130CU 22X14X14	U	27235.1	25,25
374.0008.48	TE REDUIT PRESSION A SOUDER 130CU 22X14X22	U	05402.3	11,31
374.0014.04	TE REDUIT PRESSION A SOUDER 130CU 22X16X16	U	05405.6	18,72
374.0009.02	TE REDUIT PRESSION A SOUDER 130CU 22X16X22	U	05407.2	12,02
374.0023.99	TE REDUIT PRESSION A SOUDER 130CU 22X18X16	U	27247.6	31,99
374.0005.52	TE REDUIT PRESSION A SOUDER 130CU 22X18X22	U	05410.6	7,36
374.0018.65	TE REDUIT PRESSION A SOUDER 130CU 22X22X14	U	05412.2	24,87
374.0019.86	TE REDUIT PRESSION A SOUDER 130CU 22X22X16	U	05413.0	26,48
374.0030.54	TE REDUIT PRESSION A SOUDER 130CU 28X14X28	U	05417.1	40,72
374.0027.34	TE REDUIT PRESSION A SOUDER 130CU 28X16X28	U	05420.5	36,46
374.0009.14	TE REDUIT PRESSION A SOUDER 130CU 28X22X28	U	27019.9	12,18
374.0091.99	TE REDUIT PRESSION A SOUDER 130CU 32X22X32	U	59068.7	122,65
374.0024.70	TE REDUIT PRESSION A SOUDER 130CU 35X22X35	U	55583.9	32,93

CUIVRE ET LAITON

RACCORDS CUIVRE A SOUDER



MANCHON SERIE PRESSION

FF - Egal - 270Cu - EN 1254-1



	DÉSIGNATION	UT	CODE	PPHT (€)
374.0001.06	MANCHON PRESSION A SOUDER 270CU 10	U	05478.3	1,42
374.0000.64	MANCHON PRESSION A SOUDER 270CU 12	U	05479.1	0,85
374.0000.66	MANCHON PRESSION A SOUDER 270CU 14	U	05480.9	0,88
374.0000.80	MANCHON PRESSION A SOUDER 270CU 16	U	05481.7	1,06
374.0000.83	MANCHON PRESSION A SOUDER 270CU 18	U	05482.5	1,11
374.0001.30	MANCHON PRESSION A SOUDER 270CU 22	U	05484.1	1,73
374.0002.86	MANCHON PRESSION A SOUDER 270CU 28	U	27965.3	3,81
374.0003.87	MANCHON PRESSION A SOUDER 270CU 32	U	05485.8	5,16
374.0006.09	MANCHON PRESSION A SOUDER 270CU 35	U	42402.8	8,12
374.0007.38	MANCHON PRESSION A SOUDER 270CU 40	U	27966.1	9,84
374.0011.16	MANCHON PRESSION A SOUDER 270CU 42	U	27967.9	14,88
374.0019.98	MANCHON PRESSION A SOUDER 270CU 52	U	27968.7	26,64
374.0038.88	MANCHON PRESSION A SOUDER 270CU 54	U	52177.3	51,84



MANCHON SERIE PRESSION

FF - Réduit - 240Cu - EN 1254-1



	DÉSIGNATION	UT	CODE	PPHT (€)
374.0005.18	MANCHON PRESSION A SOUDER FF 240CU 12X10	U	29348.0	6,91
374.0002.13	MANCHON PRESSION A SOUDER FF 240CU 14X12	U	29350.6	2,84
374.0002.84	MANCHON PRESSION A SOUDER FF 240CU 16X12	U	29360.5	3,79
374.0002.13	MANCHON PRESSION A SOUDER FF 240CU 16X14	U	29361.3	2,84
374.0003.91	MANCHON PRESSION A SOUDER FF 240CU 18X14	U	29367.0	5,21
374.0004.22	MANCHON PRESSION A SOUDER FF 240CU 18X16	U	29362.1	5,63
374.0013.33	MANCHON PRESSION A SOUDER FF 240CU 22X12	U	29359.7	17,77
374.0005.95	MANCHON PRESSION A SOUDER FF 240CU 22X14	U	29355.5	7,93
374.0005.13	MANCHON PRESSION A SOUDER FF 240CU 22X16	U	29357.1	6,84
374.0002.77	MANCHON PRESSION A SOUDER FF 240CU 22X18	U	29368.8	3,69
374.0010.22	MANCHON PRESSION A SOUDER FF 240CU 22X20	U	29369.6	13,63
374.0020.74	MANCHON PRESSION A SOUDER FF 240CU 28X14	U	45188.0	27,66
374.0008.43	MANCHON PRESSION A SOUDER FF 240CU 28X18	U	45190.6	11,24
374.0004.35	MANCHON PRESSION A SOUDER FF 240CU 28X22	U	29365.4	5,80
374.0009.42	MANCHON PRESSION A SOUDER FF 240CU 32X22	U	29349.8	12,56
374.0008.96	MANCHON PRESSION A SOUDER FF 240CU 32X28	U	45335.7	11,95
374.0020.25	MANCHON PRESSION A SOUDER FF 240CU 35X28	U	44005.7	27,00
374.0009.85	MANCHON PRESSION A SOUDER FF 240CU 40X32	U	45272.2	13,13
374.0012.83	MANCHON PRESSION A SOUDER FF 240CU 42X32	U	25097.7	17,11
374.0022.77	MANCHON PRESSION A SOUDER FF 240CU 42X35	U	25621.4	30,36

CUIVRE ET LAITON

RACCORDS CUIVRE A SOUDER

MANCHON SERIE PRESSION
 MF - Réduit - 243Cu - EN 1254-1

	DÉSIGNATION	UT	CODE	PPHT (€)
374.0002.72	REDUCTION PRESSION A SOUDER 243CU 12X10	U	05436.1	3,62
374.0003.28	REDUCTION PRESSION A SOUDER 243CU 14X10	U	05437.9	4,38
374.0001.78	REDUCTION PRESSION A SOUDER 243CU 14X12	U	05438.7	2,37
374.0002.78	REDUCTION PRESSION A SOUDER 243CU 16X12	U	05440.3	3,71
374.0001.47	REDUCTION PRESSION A SOUDER 243CU 16X14	U	05441.1	1,96
374.0003.07	REDUCTION PRESSION A SOUDER 243CU 18X12	U	05442.9	4,09
374.0002.36	REDUCTION PRESSION A SOUDER 243CU 18X14	U	05443.7	3,15
374.0002.20	REDUCTION PRESSION A SOUDER 243CU 18X16	U	05444.5	2,93
374.0007.03	REDUCTION PRESSION A SOUDER 243CU 22X12	U	05448.6	9,37
374.0003.82	REDUCTION PRESSION A SOUDER 243CU 22X14	U	05449.4	5,09
374.0003.44	REDUCTION PRESSION A SOUDER 243CU 22X16	U	05450.2	4,59
374.0002.18	REDUCTION PRESSION A SOUDER 243CU 22X18	U	05451.0	2,91
374.0014.46	REDUCTION PRESSION A SOUDER 243CU 28X12	U	29588.1	19,28
374.0015.65	REDUCTION PRESSION A SOUDER 243CU 28X14	U	29589.9	20,87
374.0016.20	REDUCTION PRESSION A SOUDER 243CU 28X16	U	05453.6	21,60
374.0007.94	REDUCTION PRESSION A SOUDER 243CU 28X18	U	05454.4	10,58
374.0003.48	REDUCTION PRESSION A SOUDER 243CU 28X22	U	05456.9	4,64
374.0008.96	REDUCTION PRESSION A SOUDER 243CU 32X22	U	27875.4	11,95
374.0008.96	REDUCTION PRESSION A SOUDER 243CU 32X28	U	05457.7	11,95
374.0016.24	REDUCTION PRESSION A SOUDER 243CU 35X22	U	79359.6	21,65
374.0010.84	REDUCTION PRESSION A SOUDER 243CU 35X28	U	55586.2	14,46
374.0016.45	REDUCTION PRESSION A SOUDER 243CU 40X28	U	27878.8	21,93
374.0009.34	REDUCTION PRESSION A SOUDER 243CU 40X32	U	27824.2	12,45
374.0013.51	REDUCTION PRESSION A SOUDER 243CU 42X32	U	27876.2	18,01
374.0019.45	REDUCTION PRESSION A SOUDER 243CU 42X35	U	52176.5	25,93
374.0030.04	REDUCTION PRESSION A SOUDER 243CU 52X40	U	27881.2	40,06
374.0031.71	REDUCTION PRESSION A SOUDER 243CU 52X42	U	27882.0	42,28
374.0045.23	REDUCTION PRESSION A SOUDER 243CU 54X35	U	79367.9	60,31
374.0028.76	REDUCTION PRESSION A SOUDER 243CU 54X42	U	52169.0	38,35

BOUCHON SERIE PRESSION
 Femelle - 300Cu - EN 1254-1

	DÉSIGNATION	UT	CODE	PPHT (€)
374.0003.88	BOUCHON PRESSION A SOUDER 300CU 10	U	00300.4	5,18
374.0002.98	BOUCHON PRESSION A SOUDER 300CU 12	U	05497.3	3,97
374.0006.82	BOUCHON PRESSION A SOUDER 300CU 14	U	05498.1	9,09
374.0007.76	BOUCHON PRESSION A SOUDER 300CU 16	U	05499.9	10,34
374.0001.99	BOUCHON PRESSION A SOUDER 300CU 18	U	05500.4	2,65
374.0003.40	BOUCHON PRESSION A SOUDER 300CU 22	U	05501.2	4,54
374.0005.91	BOUCHON PRESSION A SOUDER 300CU 28	U	30907.0	7,88
374.0017.92	BOUCHON PRESSION A SOUDER 300CU 32	U	73215.6	23,90
374.0027.02	BOUCHON PRESSION A SOUDER 300CU 42	U	62642.4	36,03
374.0039.64	BOUCHON PRESSION A SOUDER 300CU 54	U	62645.7	52,86

CUIVRE ET LAITON

RACCORDS CUIVRE A SOUDER

MANCHON SERIE VIDANGE
 MF - A joint torique - EN 1254-1

	DÉSIGNATION	UT	CODE	PPHT (€)
374.0019.14	MANCHON CU A JOINT TORIQUE MF 32	U	10434.9	25,52
374.0030.44	MANCHON CU A JOINT TORIQUE MF 40	U	59554.6	40,58

MANCHON SERIE VIDANGE
 FF - A joint torique - EN 1254-1

	DÉSIGNATION	UT	CODE	PPHT (€)
374.0019.14	MANCHON CU A JOINT TORIQUE FF 32	U	48422.0	25,52
374.0030.44	MANCHON CU A JOINT TORIQUE FF 40 V270J	U	56646.3	40,58

RACCORDS CUIVRE A SERTIR

viega
MANCHON SANPRESS SC-CONTUR
 FF - Réduit - 2215.2NC - Joint EPDM

	DÉSIGNATION	UT	CODE	PPHT (€)
371.0009.27	MANCHON BRZE 15X14 VIEGA 363420	U	88097.1	10,91
371.0010.12	MANCHON BRZE 16X15 VIEGA 363437	U	88103.7	11,91
371.0010.12	MANCHON BRZE 18X16 VIEGA 363444	U	88107.8	11,91

viega
COUDE PROFIPRESS SC-CONTUR
 FF - 45° - 2426 - Joint EPDM

	DÉSIGNATION	UT	CODE	PPHT (€)
371.0004.16	COUDE 45 AV.SC FF CUIVRE 12 VIEGA 292409	U	94249.0	4,89
371.0006.77	COUDE 45 AV.SC FF CUIVRE 14 VIEGA 444051	U	88338.9	7,96
371.0004.16	COUDE 45 AV.SC FF CUIVRE 15 VIEGA 292348	U	94256.5	4,89
371.0007.62	COUDE 45 AV.SC FF CUIVRE 16 VIEGA 444068	U	88339.7	8,96
371.0004.39	COUDE 45 AV.SC FF CUIVRE 18 VIEGA 292416	U	94258.1	5,17
371.0005.42	COUDE 45 AV.SC FF CUIVRE 22 VIEGA 292355	U	87800.9	6,38
371.0017.04	COUDE 45 AV.SC FF CUIVRE 28 VIEGA 292362	U	87840.5	20,05
371.0024.55	COUDE 45 AV.SC FF CUIVRE 35 VIEGA 292379	U	87843.9	28,88
371.0039.84	COUDE 45 AV.SC FF CUIVRE 42 VIEGA 292386	U	87846.2	46,87
371.0055.82	COUDE 45 AV.SC FF CUIVRE 54 VIEGA 292393	U	87742.3	65,67

CUIVRE ET LAITON

RACCORDS CUIVRE A SERTIR

viega

COUDE PROFIPRESS SC-CONTUR
MF - 45° - 2426.1 - Joint EPDM



	DÉSIGNATION	UT	CODE	PPHT (€)
371.0003.37	COUDE 45 AV.SC FM CUIVRE 12 VIEGA 292577	U	87754.8	3,96
371.0008.20	COUDE 45 AV.SC FM CUIVRE 14 VIEGA 444112	U	88341.3	9,65
371.0003.44	COUDE 45 AV.SC FM CUIVRE 15 VIEGA 292508	U	87757.1	4,05
371.0010.50	COUDE 45 AV.SC FM CUIVRE 16 VIEGA 444129	U	88344.7	12,35
371.0004.45	COUDE 45 AV.SC FM CUIVRE 18 VIEGA 292560	U	87760.5	5,24
371.0004.97	COUDE 45 AV.SC FM CUIVRE 22 VIEGA 292515	U	87776.1	5,85
371.0016.89	COUDE 45 AV.SC FM CUIVRE 28 VIEGA 292522	U	87779.5	19,87
371.0023.66	COUDE 45 AV.SC FM CUIVRE 35 VIEGA 292539	U	87782.9	27,84
371.0037.11	COUDE 45 AV.SC FM CUIVRE 42 VIEGA 292546	U	87783.7	43,66
371.0055.06	COUDE 45 AV.SC FM CUIVRE 54 VIEGA 292553	U	87518.7	64,78

viega

COUDE PROFIPRESS SC-CONTUR
FF - 90° - 2416 - Joint EPDM



	DÉSIGNATION	UT	CODE	PPHT (€)
371.0003.82	COUDE 90 AV.SC FF CUIVRE 12 VIEGA 291488	U	94229.2	4,49
371.0004.90	COUDE 90 AV.SC FF CUIVRE 14 VIEGA 443863	U	88321.5	5,76
371.0003.82	COUDE 90 AV.SC FF CUIVRE 15 VIEGA 291501	U	94230.0	4,49
371.0006.00	COUDE 90 AV.SC FF CUIVRE 16 VIEGA 443870	U	88324.9	7,06
371.0004.97	COUDE 90 AV.SC FF CUIVRE 18 VIEGA 291495	U	94242.5	5,85
371.0006.23	COUDE 90 AV.SC FF CUIVRE 22 VIEGA 291518	U	94245.8	7,33
371.0013.06	COUDE 90 AV.SC FF CUIVRE 28 VIEGA 291525	U	87849.6	15,36
371.0026.08	COUDE 90 AV.SC FF CUIVRE 35 VIEGA 291532	U	87852.0	30,68
371.0049.71	COUDE 90 AV.SC FF CUIVRE 42 VIEGA 291549	U	87856.1	58,48
371.0067.13	COUDE 90 AV.SC FF CUIVRE 54 VIEGA 291556	U	87858.7	78,98

viega

COUDE PROFIPRESS SC-CONTUR
MF - 90° - 2416.1 - Joint EPDM



	DÉSIGNATION	UT	CODE	PPHT (€)
371.0003.58	COUDE 90 AV.SC FM CUIVRE 12 VIEGA 291648	U	87861.1	4,21
371.0005.79	COUDE 90 AV.SC FM CUIVRE 14 VIEGA 444099	U	88327.2	6,81
371.0003.58	COUDE 90 AV.SC FM CUIVRE 15 VIEGA 291662	U	87877.7	4,21
371.0005.86	COUDE 90 AV.SC FM CUIVRE 16 VIEGA 444105	U	88335.5	6,90
371.0004.90	COUDE 90 AV.SC FM CUIVRE 18 VIEGA 291655	U	87911.4	5,76
371.0006.38	COUDE 90 AV.SC FM CUIVRE 22 VIEGA 291679	U	87933.8	7,51
371.0014.31	COUDE 90 AV.SC FM CUIVRE 28 VIEGA 291686	U	87785.2	16,83
371.0025.70	COUDE 90 AV.SC FM CUIVRE 35 VIEGA 291693	U	87788.6	30,24
371.0050.78	COUDE 90 AV.SC FM CUIVRE 42 VIEGA 291709	U	87791.0	59,74
371.0067.93	COUDE 90 AV.SC FM CUIVRE 54 VIEGA 291716	U	87797.7	79,92

CUIVRE ET LAITON

RACCORDS CUIVRE A SERTIR

viega

TE PROFIPRESS SC-CONTUR
FFF - Egal - 2418 - Joint EPDM



	DÉSIGNATION	UT	CODE	PPHT (€)
371.0005.73	TE EGAL AV.SC CUIVRE 12 VIEGA 291884	U	87661.5	6,74
371.0007.49	TE EGAL AV.SC CUIVRE 14 VIEGA 443887	U	88210.0	8,81
371.0005.73	TE EGAL AV.SC CUIVRE 15 VIEGA 291952	U	87675.5	6,74
371.0008.82	TE EGAL AV.SC CUIVRE 16 VIEGA 443894	U	88226.6	10,38
371.0007.79	TE EGAL AV.SC CUIVRE 18 VIEGA 291891	U	87698.7	9,16
371.0009.97	TE EGAL AV.SC CUIVRE 22 VIEGA 291969	U	87699.5	11,73
371.0018.05	TE EGAL AV.SC CUIVRE 28 VIEGA 291976	U	87408.1	21,24
371.0030.57	TE EGAL AV.SC CUIVRE 35 VIEGA 291983	U	87411.5	35,97
371.0059.34	TE EGAL AV.SC CUIVRE 42 VIEGA 291990	U	87414.9	69,81
371.0073.39	TE EGAL AV.SC CUIVRE 54 VIEGA 292003	U	87419.8	86,34

viega

TE PROFIPRESS SC-CONTUR
FFF - Réduit - 2418 - Joint EPDM



	DÉSIGNATION	UT	CODE	PPHT (€)
371.0011.46	TE RED. AV.SC CUIVRE 14X12X14 VIEGA 443900	U	88229.0	13,48
371.0011.46	TE RED. AV.SC CUIVRE 16X14X16 VIEGA 443924	U	88232.4	13,48
371.0007.29	TE RED. AV.SC CUIVRE 18X12X18 VIEGA 324827	U	87429.7	8,58
371.0016.54	TE RED. AV.SC CUIVRE 18X14X18 VIEGA 443931	U	88240.7	19,46
371.0013.74	TE RED. AV.SC CUIVRE 18X15X18 VIEGA 291921	U	94380.3	16,16
371.0007.03	TE RED. AV.SC CUIVRE 18X15X18 VIEGA 291938	U	94382.9	8,27
371.0021.01	TE RED. AV.SC CUIVRE 18X16X18 VIEGA 443948	U	88241.5	24,72
371.0013.80	TE RED. AV.SC CUIVRE 18X18X18 VIEGA 315009	U	87431.3	16,23
371.0018.36	TE RED. AV.SC CUIVRE 22X14X22 VIEGA 443955	U	88243.1	21,60
371.0008.45	TE RED. AV.SC CUIVRE 22X15X22 VIEGA 292027	U	87365.3	9,94
371.0019.33	TE RED. AV.SC CUIVRE 22X16X22 VIEGA 443962	U	88244.9	22,74
371.0010.80	TE RED. AV.SC CUIVRE 22X18X22 VIEGA 291945	U	87387.7	12,71
371.0020.59	TE RED. AV.SC CUIVRE 28X15X28 VIEGA 295189	U	87403.2	24,22
371.0028.42	TE RED. AV.SC CUIVRE 28X18X28 VIEGA 315023	U	60603.8	33,44
371.0027.64	TE RED. AV.SC CUIVRE 28X22X28 VIEGA 307899	U	60604.6	32,52
371.0020.49	TE RED. AV.SC CUIVRE 28X22X28 VIEGA 295196	U	60605.3	24,11
371.0031.32	TE RED. AV.SC CUIVRE 28X28X28 VIEGA 315016	U	60606.1	36,85
371.0030.29	TE RED. AV.SC CUIVRE 35X15X35 VIEGA 324865	U	60609.5	35,64
371.0032.05	TE RED. AV.SC CUIVRE 35X18X35 VIEGA 324872	U	60611.1	37,71
371.0027.76	TE RED. AV.SC CUIVRE 35X22X35 VIEGA 292034	U	60616.0	32,66
371.0053.07	TE RED. AV.SC CUIVRE 42X22X42 VIEGA 324902	U	60622.8	62,44
371.0053.89	TE RED. AV.SC CUIVRE 42X28X42 VIEGA 292058	U	60625.1	63,40

CUIVRE ET LAITON

RACCORDS CUIVRE A SERTIR



BOUCHON PROFIPRESS SC-CONTUR

Femelle - 2456 - Joint EPDM



	DÉSIGNATION	UT	CODE	PPHT (€)
371.0007.12	BOUCHON FEMELLE CUIVRE 12 VIEGA 349295	U	61914.8	8,38
371.0014.25	BOUCHON FEMELLE CUIVRE 14 VIEGA 444075	U	88297.7	16,76
371.0007.49	BOUCHON FEMELLE CUIVRE 15 VIEGA 349301	U	61979.1	8,81
371.0015.64	BOUCHON FEMELLE CUIVRE 16 VIEGA 444082	U	88300.9	18,40
371.0009.85	BOUCHON FEMELLE CUIVRE 18 VIEGA 349363	U	61917.1	11,59
371.0012.91	BOUCHON FEMELLE CUIVRE 22 VIEGA 349356	U	61921.3	15,19



MANCHON PROFIPRESS SC-CONTUR

FF - 2415 - Joint EPDM



	DÉSIGNATION	UT	CODE	PPHT (€)
371.0003.58	MANCHON AV.SC FF CUIVRE 12 VIEGA 292737	U	87154.1	4,21
371.0004.11	MANCHON AV.SC FF CUIVRE 14 VIEGA 443740	U	88246.4	4,84
371.0003.58	MANCHON AV.SC FF CUIVRE 15 VIEGA 292690	U	94259.9	4,21
371.0004.45	MANCHON AV.SC FF CUIVRE 16 VIEGA 443856	U	88249.8	5,24
371.0004.53	MANCHON AV.SC FF CUIVRE 18 VIEGA 292744	U	94260.7	5,33
371.0005.36	MANCHON AV.SC FF CUIVRE 22 VIEGA 292683	U	87157.4	6,30
371.0010.25	MANCHON AV.SC FF CUIVRE 28 VIEGA 292676	U	87164.0	12,06
371.0012.78	MANCHON AV.SC FF CUIVRE 35 VIEGA 292706	U	87167.3	15,03
371.0024.04	MANCHON AV.SC FF CUIVRE 42 VIEGA 292713	U	87170.7	28,28
371.0030.20	MANCHON AV.SC FF CUIVRE 54 VIEGA 292720	U	87173.1	35,53



MANCHON PROFIPRESS SC-CONTUR

FF - Réduit - 2415.2 - Joint EPDM



	DÉSIGNATION	UT	CODE	PPHT (€)
371.0015.81	REDUCTION AV.SC FF CUIVRE 22X15 VIEGA 325794	U	87236.6	18,60
371.0016.01	REDUCTION AV.SC FF CUIVRE 22X18 VIEGA 325800	U	86832.3	18,83
371.0017.99	REDUCTION AV.SC FF CUIVRE 28X22 VIEGA 325817	U	86855.4	21,17
371.0025.34	REDUCTION AV.SC FF CUIVRE 35X28 VIEGA 328269	U	61164.0	29,81

CUIVRE ET LAITON

RACCORDS CUIVRE A SERTIR ET A VISSER



COUDE SANPRESS SC-CONTUR

FM - 90° - 2214 - Joint EPDM



	DÉSIGNATION	UT	CODE	PPHT (€)
371.0016.83	COUDE 90 AV.SC FM BRZE 14X1/2 VIEGA 444006	U	88187.0	19,80
371.0018.39	COUDE 90 AV.SC FM BRZE 16X1/2 VIEGA 444013	U	88193.8	21,64
371.0030.63	COUDE 90 AV.SC FM BRZE 22X3/4 VIEGA 115623	U	87591.4	36,03



COUDE SANPRESS SC-CONTUR

FF - 90° - 2214.2 - Joint EPDM



	DÉSIGNATION	UT	CODE	PPHT (€)
371.0011.72	COUDE 90 AV.SC FF BRZE 12X3/8 VIEGA 290924	U	66740.2	13,79
371.0015.33	COUDE 90 AV.SC FF BRZE 14X1/2 VIEGA 444020	U	88196.1	18,03
371.0011.72	COUDE 90 AV.SC FF BRZE 15X1/2 VIEGA 108441	U	66592.7	13,79
371.0012.97	COUDE 90 AV.SC FF BRZE 16X1/2 VIEGA 444037	U	88198.7	15,26



APPLIQUE SANPRESS SC-CONTUR

FF - Murale - 2225.5 - Joint EPDM



	DÉSIGNATION	UT	CODE	PPHT (€)
371.0018.80	APPLIQUE MUR.FF BRZE 14X1/2 VIEGA 444044	U	88162.3	18,80
371.0012.82	APPLIQUE MUR.FF BRZE 15X1/2 VIEGA 107345	U	61936.1	15,08



TE SANPRESS SC-CONTUR

FFF - 2217-2 - Joint EPDM, 6 pans



	DÉSIGNATION	UT	CODE	PPHT (€)
371.0018.10	TE AV.SC FFF BRZE 15X1/2X15 VIEGA 115630	U	66568.7	21,30



MANCHON SANPRESS SC-CONTUR

FM - Pièce de transition - 2211 - Joint EPDM 6 pans



	DÉSIGNATION	UT	CODE	PPHT (€)
371.0005.59	REDUCTION AV.SC FM BRZE 12X3/8 VIEGA 290771	U	87938.7	6,58

CUIVRE ET LAITON

RACCORDS CUIVRE A SERTIR ET A VISSER

viega

MANCHON SANPRESS SC-CONTUR

FM - Pièce de transition - 2211 -

Joint EPDM 6 pans

- suite



	DÉSIGNATION	UT	CODE	PPHT (€)
371.0004.03	REDUCTION AV.SC FM BRZE 12X1/2 VIEGA 290764	U	66574.5	4,74
371.0006.35	REDUCTION AV.SC FM BRZE 14X3/8 VIEGA 443689	U	88032.8	7,47
371.0008.42	REDUCTION AV.SC FM BRZE 14X1/2 VIEGA 443696	U	88071.6	9,90
371.0006.22	REDUCTION AV.SC FM BRZE 15X3/8 VIEGA 297985	U	66575.2	7,32
371.0004.03	REDUCTION AV.SC FM BRZE 15X1/2 VIEGA 105044	U	87951.0	4,74
371.0008.29	REDUCTION AV.SC FM BRZE 15X3/4 VIEGA 287764	U	60655.8	9,75
371.0008.29	REDUCTION AV.SC FM BRZE 16X1/2 VIEGA 443702	U	88080.7	9,75
371.0012.27	REDUCTION AV.SC FM BRZE 16X3/4 VIEGA 443719	U	88085.6	14,44
371.0005.16	REDUCTION AV.SC FM BRZE 18X1/2 VIEGA 283490	U	87953.6	6,07
371.0005.87	REDUCTION AV.SC FM BRZE 18X3/4 VIEGA 283230	U	61869.4	6,91
371.0010.28	REDUCTION AV.SC FM BRZE 22X1 VIEGA 287771	U	87954.4	12,09
371.0008.42	REDUCTION AV.SC FM BRZE 22X3/4 VIEGA 104306	U	60659.0	9,90
371.0014.25	REDUCTION AV.SC FM BRZE 28X1" VIEGA 106508	U	87957.7	16,76
371.0029.41	REDUCTION AV.SC FM BRZE 28X11/4 VIEGA 297978	U	67171.9	34,60
371.0032.52	REDUCTION AV.SC FM BRZE 35X1" VIEGA 297947	U	61876.9	38,26
371.0031.17	REDUCTION AV.SC FM BRZE 35X11/4 VIEGA 110352	U	66583.6	36,67
371.0043.69	REDUCTION AV.SC FM BRZE 42X11/2 VIEGA 115340	U	61983.3	51,40
371.0042.60	REDUCTION AV.SC FM BRZE 42X11/4 VIEGA 297930	U	67173.5	49,88
371.0084.26	REDUCTION AV.SC FM BRZE 54X2 VIEGA 195267	U	60660.8	99,13

viega

MANCHON SANPRESS SC-CONTUR

FF - Pièce de transition - 2212 - Joint

EPDM 6 pans



	DÉSIGNATION	UT	CODE	PPHT (€)
371.0004.96	RACCORD AV.SC FF BRZE 12X3/8 VIEGA 291075	U	87960.1	5,83
371.0005.53	RACCORD AV.SC FF BRZE 14X1/2 VIEGA 443726	U	88088.0	6,51
371.0005.46	RACCORD AV.SC FF BRZE 15X3/8 VIEGA 298074	U	61890.0	6,42
371.0005.01	RACCORD AV.SC FF BRZE 15X1/2 VIEGA 107543	U	87971.8	5,89
371.0005.61	RACCORD AV.SC FF BRZE 16X1/2 VIEGA 443733	U	88093.0	6,60
371.0013.68	RACCORD AV.SC FF BRZE 18X3/4 VIEGA 294519	U	61894.2	16,10
371.0007.71	RACCORD AV.SC FF BRZE 22X1/2 VIEGA 298067	U	61895.9	9,07
371.0008.44	RACCORD AV.SC FF BRZE 22X3/4 VIEGA 108465	U	61897.5	9,93
371.0012.55	RACCORD AV.SC FF BRZE 22X1" VIEGA 298128	U	67229.5	14,76
371.0015.48	RACCORD AV.SC FF BRZE 28X1 VIEGA 114329	U	67234.5	18,21
371.0028.41	RACCORD AV.SC FF BRZE 28X11/4 VIEGA 298104	U	67237.8	33,42
371.0034.22	RACCORD AV.SC FF BRZE 35X11/4 VIEGA 116774	U	67242.8	40,26

CUIVRE ET LAITON

RACCORDS CUIVRE A SERTIR ET A VISSER

viega

RACCORD SANPRESS SC-CONTUR

FM - 3 pièces - 2265 - Joint plat



	DÉSIGNATION	UT	CODE	PPHT (€)
371.0038.47	RACCORD UNION FM BRZE 18X3/4 VIEGA 283377	U	87516.1	45,26
371.0040.19	RACCORD UNION FM BRZE 22X3/4 VIEGA 119133	U	61947.8	47,28
371.0058.05	RACCORD UNION FM BRZE 22X1 VIEGA 148492	U	87977.5	68,29
371.0047.59	RACCORD UNION FM BRZE 28X1 VIEGA 120047	U	87992.4	55,99
371.0069.48	RACCORD UNION FM BRZE 35X11/4 VIEGA 128425	U	61948.6	81,74
371.0096.91	RACCORD UNION FM BRZE 42X11/2 VIEGA 135966	U	61955.1	114,01
371.0127.06	RACCORD UNION FM BRZE 54X2 VIEGA 221997	U	61959.3	149,48

viega

RACCORD SANPRESS SC-CONTUR

FF - Ecrou tournant - 2263 - Joint EPDM



	DÉSIGNATION	UT	CODE	PPHT (€)
371.0010.80	RACCORD UN.+JT PL.BRZE 12X3/8 VIEGA 475956	U	7706A.0	12,70
371.0010.91	RACCORD UN.+JT PL.BRZE 12X1/2 VIEGA 380878	U	87995.7	12,84
371.0011.62	RACCORD UN.+JT PL.BRZE 14X3/8 VIEGA 476786	U	93808.4	13,67
371.0011.93	RACCORD UN.+JT PL.BRZE 14X1/2 VIEGA 443849	U	88131.8	14,04
371.0011.14	RACCORD UN.+JT PL.BRZE 14X3/4 VIEGA 444150	U	88134.2	13,10
371.0010.91	RACCORD UN.+JT PL.BRZE 15X1/2 VIEGA 380885	U	66596.8	12,84
371.0009.78	RACCORD UN.+JT PL.BRZE 15X3/4 VIEGA 265663	U	88010.4	11,51
371.0012.06	RACCORD UN.+JT PL.BRZE 16X1/2 VIEGA 444167	U	88145.8	14,19
371.0010.71	RACCORD UN.+JT PL.BRZE 16X3/4 VIEGA 444174	U	88158.1	12,60
371.0010.06	RACCORD UN.+JT PL.BRZE 18X3/4 VIEGA 283391	U	88023.7	11,84
371.0014.13	RACCORD UN.+JT PL.BRZE 18X1" VIEGA 305017	U	67644.5	16,62
371.0013.13	RACCORD UN.+JT PL.BRZE 22X3/4 VIEGA 351502	U	61961.9	15,45
371.0009.93	RACCORD UN.+JT PL.BRZE 22X1" VIEGA 265687	U	88025.2	11,68
371.0018.92	RACCORD UN.+JT PL.BRZE 28X1" VIEGA 692629	U	62708.6	18,92
371.0016.61	RACCORD UN.+JT PL.BRZE 28X11/4 VIEGA 265700	U	86729.1	19,54
371.0019.44	RACCORD UN.+JT PL.BRZE 35X11/2 VIEGA 265731	U	67654.4	22,87
371.0045.60	RACCORD UN.+JT PL.BRZE 42X2" VIEGA 305031	U	67679.1	53,65

viega

UNITE DE MONTAGE SANPRESS SC-CONTUR

Cour - 2222.05 - Support plat - Joint EPDM -

Entraxe 150



	DÉSIGNATION	UT	CODE	PPHT (€)
371.0035.30	UNITE DE MONTAGE 15X1/2X150 VIEGA 308681	U	65460.8	41,53

CUIVRE ET LAITON

RACCORDS CUIVRE A SERTIR ET A VISSER

Conex | Bänninger

TE B PRESS

FFF - 4130G



	DÉSIGNATION	UT	CODE	PPHT (€)
025.0024.47	TE SERT.EAU FFF 14X1/2X14 P8130G01404014	U	181V7.7	24,47
025.0020.80	TE SERT.EAU FFF 16X1/2X16 P8130G01604016	U	181VA.0	20,80

RACCORDS LAITON A SOUDER ET A VISSER



COUDE

MF - 92GCU



	DÉSIGNATION	UT	CODE	PPHT (€)
375.0002.47	COUDE 90.MF PR.A SOUDER LAITON 92GCU 12 12X17	U	05333.0	3,29
375.0002.73	COUDE 90.MF PR.A SOUDER LAITON 92GCU 14 12X17	U	26490.3	3,64
375.0002.79	COUDE 90.MF PR.A SOUDER LAITON 92GCU 14 15X21	U	05335.5	3,72
375.0003.21	COUDE 90.MF PR.A SOUDER LAITON 92GCU 16 15X21	U	05336.3	4,28



COUDE

FF - 90° - 90GCU



	DÉSIGNATION	UT	CODE	PPHT (€)
375.0003.49	COUDE 90.FF PR.A SOUDER LAITON 90GCU 12 12X17	U	05326.4	4,65
375.0002.90	COUDE 90.FF PR.A SOUDER LAITON 90GCU 12 15X21	U	05327.2	3,87
375.0003.00	COUDE 90.FF PR.A SOUDER LAITON 90GCU 14 12X17	U	05328.0	4,00
375.0002.80	COUDE 90.FF PR.A SOUDER LAITON 90GCU 14 15X21	U	05329.8	3,73
375.0003.08	COUDE 90.FF PR.A SOUDER LAITON 90GCU 16 15X21	U	05330.6	4,10
375.0006.03	COUDE 90.FF PR.A SOUDER LAITON 90GCU 16 20X27	U	24853.4	8,04
375.0004.17	COUDE 90.FF PR.A SOUDER LAITON 90GCU 18 15X21	U	05331.4	5,56
375.0007.00	COUDE 90.FF PR.A SOUDER LAITON 90GCU 22 20X27	U	05332.2	9,34



COUDE

FF - 90° - 90GLCU



	DÉSIGNATION	UT	CODE	PPHT (€)
375.0014.67	COUDE 90.FF PR.A SOUDER LAITON 90GLCU14 15X21	U	26598.3	19,56

CUIVRE ET LAITON

RACCORDS LAITON A SOUDER ET A VISSER



COUDE

FF - 90° - Avec écrou - 2GC - EN 1254-1



	DÉSIGNATION	UT	CODE	PPHT (€)
375.0004.46	COUDE 90+ECR.PRIS.F.PR.LAITON 2GCU 14 12X17	U	00311.1	5,95
375.0004.06	COUDE 90+ECR.PRIS.F.PR.LAITON 2GCU 14 15X21	U	12254.9	5,41
375.0007.30	COUDE 90+ECR.PRIS.F.PR.LAITON 2GCU 14 20X27	U	08704.9	9,74
375.0006.32	COUDE 90+ECR.PRIS.F.PR.LAITON 2GCU 16 20X27	U	12255.6	8,43
375.0004.35	COUDE 90+ECR.PRIS.F.PR.LAITON 2GCU 16 15X21	U	59371.5	5,80
375.0006.51	COUDE 90+ECR.PRIS.F.PR.LAITON 2GCU 18 20X27	U	60041.1	8,68
375.0007.22	COUDE 90+ECR.PRIS.F.PR.LAITON 2GCU 22 20X27	U	12258.0	9,63



COUDE

MM - Avec écrou flottant



	DÉSIGNATION	UT	CODE	PPHT (€)
030.0018.02	COUDE ECROU FLOTTANT M LAITON 3/4	U	260CA.5	24,02



TE

FFF - 130GCU



	DÉSIGNATION	UT	CODE	PPHT (€)
375.0004.09	TE PRESSION A SOUDER LAITON 130GCU 12 1/2	U	05424.7	5,45
375.0004.13	TE PRESSION A SOUDER LAITON 130GCU 14 1/2	U	05425.4	5,51
375.0005.10	TE PRESSION A SOUDER LAITON 130GCU 16 1/2	U	05426.2	6,80



UNION

MF - Droit - 341GCU

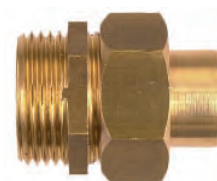

	DÉSIGNATION	UT	CODE	PPHT (€)
375.0004.53	UNION PR.A SOUDER LAITON 341GCU 12 12X17	U	05508.7	6,04
375.0005.11	UNION PR.A SOUDER LAITON 341GCU 12 15X21	U	28321.8	6,81
375.0004.50	UNION PR.A SOUDER LAITON 341GCU 14 12X17	U	05509.5	6,00
375.0004.37	UNION PR.A SOUDER LAITON 341GCU 14 15X21	U	05510.3	5,83
375.0006.43	UNION PR.A SOUDER LAITON 341GCU 16 15X21	U	05511.1	8,57
375.0006.75	UNION PR.A SOUDER LAITON 341GCU 16 20X27	U	50103.1	9,00
375.0007.42	UNION PR.A SOUDER LAITON 341GCU 18 15X21	U	28319.2	9,90
375.0007.37	UNION PR.A SOUDER LAITON 341GCU 18 20X27	U	45039.5	9,83
375.0009.65	UNION PR.A SOUDER LAITON 341GCU 22 20X27	U	05512.9	12,87
375.0012.22	UNION PR.A SOUDER LAITON 341GCU 22 26X34	U	28329.1	16,29
375.0016.08	UNION PR.A SOUDER LAITON 341GCU 28 26X34	U	28323.4	21,44
375.0023.31	UNION PR.A SOUDER LAITON 341GCU 28 33X42	U	31054.0	31,08

CUIVRE ET LAITON

RACCORDS LAITON A SOUDER ET A VISSER



UNION
MF - Droit - 341GCU
- suite

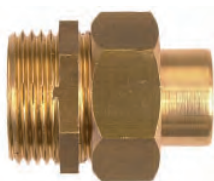

	DÉSIGNATION	UT	CODE	PPHT (€)
375.0023.30	UNION PR.A SOUDER LAITON 341GCU 32 26X34	U	63248.9	31,07
375.0019.41	UNION PR.A SOUDER LAITON 341GCU 32 33X42	U	28324.2	25,88
375.0047.28	UNION PR.A SOUDER LAITON 341GCU 35 33X42	U	01875.4	63,04
375.0041.95	UNION PR.A SOUDER LAITON 341GCU 40 40X49	U	45265.6	55,93
375.0045.02	UNION PR.A SOUDER LAITON 341GCU 42 40X49	U	45266.4	60,02
375.0074.38	UNION PR.A SOUDER LAITON 341GCU 52 50X60	U	76055.3	99,17
375.0076.89	UNION PR.A SOUDER LAITON 341GCU 54 50X60	U	23800.6	102,52



UNION
FF - 340GCU

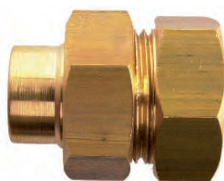

	DÉSIGNATION	UT	CODE	PPHT (€)
375.0005.72	UNION PR.A SOUDER LAITON 340GCU 14 12X17	U	28257.4	7,62
375.0004.81	UNION PR.A SOUDER LAITON 340GCU 14 15X21	U	05506.1	6,41
375.0006.47	UNION PR.A SOUDER LAITON 340GCU 16 15X21	U	05505.3	8,63
375.0007.54	UNION PR.A SOUDER LAITON 340GCU 16 20X27	U	45175.7	10,05
375.0007.57	UNION PR.A SOUDER LAITON 340GCU 18 15X21	U	28253.3	10,09
375.0007.64	UNION PR.A SOUDER LAITON 340GCU 18 20X27	U	28258.2	10,18
375.0009.76	UNION PR.A SOUDER LAITON 340GCU 22 20X27	U	05507.9	13,01
375.0012.64	UNION PR.A SOUDER LAITON 340GCU 22 26X34	U	45219.3	16,85
375.0017.23	UNION PR.A SOUDER LAITON 340GCU 28 26X34	U	28254.1	22,97
375.0027.46	UNION PR.A SOUDER LAITON 340GCU 32 26X34	U	52571.7	36,62
375.0021.08	UNION PR.A SOUDER LAITON 340GCU 32 33X42	U	28251.7	28,10
375.0045.12	UNION PR.A SOUDER LAITON 340GCU 42 40X49	U	28250.9	60,16
375.0072.52	UNION PR.A SOUDER LAITON 340GCU 52 50X60	U	09784.0	96,69
375.0073.24	UNION PR.A SOUDER LAITON 340GCU 54 50X60	U	27498.5	97,66



MANCHON
FF - Droit - 270GCU



	DÉSIGNATION	UT	CODE	PPHT (€)
375.0001.90	MANCHON PR.A SOUDER LAITON 270GCU 10 12X17	U	05487.4	2,53
375.0001.75	MANCHON PR.A SOUDER LAITON 270GCU 12 12X17	U	05489.0	2,33
375.0002.55	MANCHON PR.A SOUDER LAITON 270GCU 12 15X21	U	05490.8	3,40
375.0001.74	MANCHON PR.A SOUDER LAITON 270GCU 14 12X17	U	05491.6	2,32
375.0002.04	MANCHON PR.A SOUDER LAITON 270GCU 14 15X21	U	05492.4	2,72
375.0004.42	MANCHON PR.A SOUDER LAITON 270GCU 14 20X27	U	27999.2	5,89
375.0002.25	MANCHON PR.A SOUDER LAITON 270GCU 16 15X21	U	05493.2	3,00
375.0003.52	MANCHON PR.A SOUDER LAITON 270GCU 16 20X27	U	28000.8	4,69
375.0002.38	MANCHON PR.A SOUDER LAITON 270GCU 18 15X21	U	05494.0	3,18
375.0003.63	MANCHON PR.A SOUDER LAITON 270GCU 18 20X27	U	05495.7	4,84

CUIVRE ET LAITON

RACCORDS LAITON A SOUDER ET A VISSER



MANCHON
FF - Droit - 270GCU
- suite



	DÉSIGNATION	UT	CODE	PPHT (€)
375.0005.56	MANCHON PR.A SOUDER LAITON 270GCU 20 20X27	U	27988.5	7,42
375.0003.64	MANCHON PR.A SOUDER LAITON 270GCU 22 20X27	U	05496.5	4,86
375.0006.40	MANCHON PR.A SOUDER LAITON 270GCU 28 26X34	U	27989.3	8,54
375.0011.69	MANCHON PR.A SOUDER LAITON 270GCU 32 33X42	U	27990.1	15,59
375.0033.86	MANCHON PR.A SOUDER LAITON 270GCU 52 50X60	U	06641.5	45,15



MAMELON
MF - Droit - 243GCU



	DÉSIGNATION	UT	CODE	PPHT (€)
375.0001.47	MAMELON PR.A SOUDER LAITON 243GCU 10 12X17	U	05464.3	1,96
375.0001.17	MAMELON PR.A SOUDER LAITON 243GCU 12 12X17	U	05465.0	1,56
375.0002.06	MAMELON PR.A SOUDER LAITON 243GCU 12 15X21	U	05466.8	2,75
375.0001.03	MAMELON PR.A SOUDER LAITON 243GCU 14 12X17	U	05467.6	1,37
375.0001.66	MAMELON PR.A SOUDER LAITON 243GCU 14 15X21	U	05468.4	2,22
375.0004.36	MAMELON PR.A SOUDER LAITON 243GCU 14 20X27	U	27948.9	5,81
375.0002.90	MAMELON PR.A SOUDER LAITON 243GCU 16 12X17	U	39987.3	3,86
375.0001.64	MAMELON PR.A SOUDER LAITON 243GCU 16 15X21	U	05469.2	2,18
375.0003.32	MAMELON PR.A SOUDER LAITON 243GCU 16 20X27	U	29646.7	4,43
375.0001.91	MAMELON PR.A SOUDER LAITON 243GCU 18 15X21	U	05470.0	2,55
375.0003.19	MAMELON PR.A SOUDER LAITON 243GCU 18 20X27	U	29605.3	4,25
375.0002.88	MAMELON PR.A SOUDER LAITON 243GCU 22 20X27	U	05475.9	3,84
375.0006.52	MAMELON PR.A SOUDER LAITON 243GCU 22 26X34	U	05476.7	8,69
375.0008.00	MAMELON PR.A SOUDER LAITON 243GCU 28 20X27	U	27944.8	10,66
375.0004.88	MAMELON PR.A SOUDER LAITON 243GCU 28 26X34	U	05473.4	6,50
375.0010.55	MAMELON PR.A SOUDER LAITON 243GCU 32 33X42	U	28017.2	14,07
375.0034.94	MAMELON PR.A SOUDER LAITON 243GCU 35 33X42	U	01842.4	46,58
375.0013.49	MAMELON PR.A SOUDER LAITON 243GCU 40 40X49	U	28016.4	17,99
375.0013.55	MAMELON PR.A SOUDER LAITON 243GCU 42 40X49	U	27946.3	18,07
375.0027.08	MAMELON PR.A SOUDER LAITON 243GCU 52 50X60	U	28366.3	36,11
375.0027.08	MAMELON PR.A SOUDER LAITON 243GCU 54 50X60	U	07301.5	36,11



RACCORD
FF - Long - 2 pièces - 359GLCU



	DÉSIGNATION	UT	CODE	PPHT (€)
375.0002.38	RACCORD 2P.PR.A SOUD.LAIT. 359GLCU10 12X17	U	60780.4	3,17
375.0002.17	RACCORD 2P.PR.A SOUD.LAIT. 359GLCU12 12X17	U	25196.7	2,89
375.0002.56	RACCORD 2P.PR.A SOUD.LAIT. 359GLCU12 15X21	U	26652.8	3,42
375.0002.49	RACCORD 2P.PR.A SOUD.LAIT. 359GLCU14 12X17	U	76039.7	3,32
375.0002.39	RACCORD 2P.PR.A SOUD.LAIT. 359GLCU14 15X21	U	26653.6	3,19

CUIVRE ET LAITON

RACCORDS LAITON A SOUDER ET A VISSER



RACCORD

FF - Long - 2 pièces - 359GLCU
- suite



	DÉSIGNATION	UT	CODE	PPHT (€)
375.0002.65	RACCORD 2P.PR.A SOUD.LAIT. 359GLCU16 15X21	U	50341.7	3,53
375.0003.80	RACCORD 2P.PR.A SOUD.LAIT. 359GLCU18 15X21	U	30016.0	5,07
375.0004.23	RACCORD 2P.PR.A SOUD.LAIT. 359GLCU14 20X27	U	26654.4	5,64
375.0004.10	RACCORD 2P.PR.A SOUD.LAIT. 359GLCU16 20X27	U	26655.1	5,46
375.0003.76	RACCORD 2P.PR.A SOUD.LAIT. 359GLCU18 20X27	U	26656.9	5,01
375.0005.07	RACCORD 2P.PR.A SOUD.LAIT. 359GLCU20 20X27	U	26659.3	6,76
375.0004.46	RACCORD 2P.PR.A SOUD.LAIT. 359GLCU22 20X27	U	58481.3	5,95
375.0006.70	RACCORD 2P.PR.A SOUD.LAIT. 359GLCU22 26X34	U	26661.9	8,93
375.0008.10	RACCORD 2P.PR.A SOUD.LAIT. 359GLCU28 26X34	U	41037.3	10,80
375.0016.18	RACCORD 2P.PR.A SOUD.LAIT. 359GLCU32 33X42	U	68491.0	21,57

Raccords
DUMONT

MANCHON

MF - 243GCU - D110

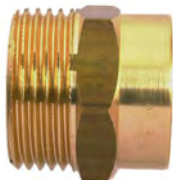

	DÉSIGNATION	UT	CODE	PPHT (€)
375.0045.11	MANCHON F/C 243GCU MALE 1"1/4-40 D110175	U	8090C.8	60,15

Raccords
DUMONT

RACCORD

FF - 2 pièces - Droit - 359GCL - D121



	DÉSIGNATION	UT	CODE	PPHT (€)
375.0022.73	RACCORD 2PCES DOUIL.CU 359GCL1"1/2-40 D12115B	U	47843.8	37,89
375.0028.09	RACCORD 2PCES DOUIL.CU 359GCL1"1/2-42 D121165	U	94511.3	37,45

viEGA

RACCORD PROFIPRESS G

Femelle - Erou libre - 2664 - Joint plat



	DÉSIGNATION	UT	CODE	PPHT (€)
371.0016.91	RACCORD ECR.LIBRE BRZE 14X20/150 VIEGA 677718	U	78341.5	16,91

CUIVRE ET LAITON

RACCORDS LAITON A SOUDER ET A VISSER

viEGA

REDUCTION SANPRESS SC-
CONTUR

MF - 2215.1NC



	DÉSIGNATION	UT	CODE	PPHT (€)
371.0006.66	REDUCTION MF BRZE 15X14 VIEGA 323707	U	88111.0	7,83
371.0007.57	REDUCTION MF BRZE 15X16 VIEGA 323714	U	88117.7	8,91

viEGA

REDUCTION PROFIPRESS SC-
CONTUR

MF - 2415.1 - Joint EPDM



	DÉSIGNATION	UT	CODE	PPHT (€)
371.0003.88	REDUCTION AV.SC MF CUIVRE 14X12 VIEGA 443771	U	88261.3	4,57
371.0003.21	REDUCTION AV.SC MF CUIVRE 15X12 VIEGA 296414	U	87056.8	3,78
371.0004.11	REDUCTION AV.SC MF CUIVRE 16X14 VIEGA 443795	U	88270.4	4,84
371.0006.66	REDUCTION AV.SC MF CUIVRE 18X14 VIEGA 443801	U	88273.8	7,83
371.0003.21	REDUCTION AV.SC MF CUIVRE 18X15 VIEGA 296407	U	87131.9	3,78
371.0006.88	REDUCTION AV.SC MF CUIVRE 18X16 VIEGA 443818	U	88276.1	8,10
371.0006.09	REDUCTION AV.SC MF CUIVRE 22X14 VIEGA 443825	U	88282.9	7,16
371.0003.82	REDUCTION AV.SC MF CUIVRE 22X15 VIEGA 296377	U	87139.2	4,49
371.0004.90	REDUCTION AV.SC MF CUIVRE 22X16 VIEGA 443832	U	88294.4	5,76
371.0004.00	REDUCTION AV.SC MF CUIVRE 22X18 VIEGA 296391	U	60662.4	4,71
371.0009.90	REDUCTION AV.SC MF CUIVRE 28X18 VIEGA 296384	U	87434.7	11,65
371.0010.30	REDUCTION AV.SC MF CUIVRE 28X22 VIEGA 296506	U	87437.0	12,12
371.0012.04	REDUCTION AV.SC MF CUIVRE 35X22 VIEGA 296452	U	60663.2	14,16
371.0013.14	REDUCTION AV.SC MF CUIVRE 35X28 VIEGA 296490	U	60664.0	15,46
371.0020.05	REDUCTION AV.SC MF CUIVRE 42X28 VIEGA 296483	U	61975.9	23,59
371.0019.53	REDUCTION AV.SC MF CUIVRE 42X35 VIEGA 296476	U	60668.1	22,98
371.0027.35	REDUCTION AV.SC MF CUIVRE 54X35 VIEGA 296438	U	60670.7	32,18
371.0026.18	REDUCTION AV.SC MF CUIVRE 54X42 VIEGA 296421	U	60677.2	30,80

viEGA

EMBOUT SANPRESS

MM - 2211.1 - Six pans



	DÉSIGNATION	UT	CODE	PPHT (€)
371.0014.63	EMBOUT MM BRZE 15X1/2 VIEGA 115418	U	87731.6	17,21

viEGA

EMBOUT SANPRESS

MF - 2212-1 - Six pans



	DÉSIGNATION	UT	CODE	PPHT (€)
371.0016.24	EMBOUT MF BRZE 15X1/2 VIEGA 117733	U	87737.3	19,11

CUIVRE ET LAITON

RACCORDS LAITON A VISSER



COUDE

FF - 90° - Brut



	DÉSIGNATION	UT	CODE	PPHT (€)
375.0003.78	COUDE FEMELLE LAITON BRUT 12X17	U	23939.2	5,04
375.0004.31	COUDE FEMELLE LAITON BRUT 15X21	U	24970.6	5,75
375.0007.11	COUDE FEMELLE LAITON BRUT 20X27	U	24972.2	9,48
375.0012.07	COUDE FEMELLE LAITON BRUT 26X34	U	32133.1	16,09
375.0027.28	COUDE FEMELLE LAITON BRUT 33X42	U	31951.7	36,38
375.0037.96	COUDE FEMELLE LAITON BRUT 40X49	U	52592.3	50,61
375.0061.90	COUDE FEMELLE LAITON BRUT 50X60	U	45210.2	82,53



COUDE

MF - 90° - Brut



	DÉSIGNATION	UT	CODE	PPHT (€)
375.0010.75	COUDE COURT MF CB LAITON BRUT 8X13	U	44092.5	10,75
375.0003.92	COUDE COURT MF CB LAITON BRUT 12X17	U	52739.0	5,22
375.0004.86	COUDE COURT MF CB LAITON BRUT 15X21	U	38726.6	6,48
375.0006.90	COUDE COURT MF CB LAITON BRUT 20X27	U	38732.4	9,20
375.0012.92	COUDE COURT MF CB LAITON BRUT 26X34	U	74505.9	17,23
375.0028.09	COUDE COURT MF CB LAITON BRUT 33X42	U	68861.4	37,45
375.0048.85	COUDE COURT MF CB LAITON BRUT 40X49	U	68984.4	65,13
375.0069.81	COUDE COURT MF CB LAITON BRUT 50X60	U	69034.7	93,08



COUDE

MM - 90° - Brut



	DÉSIGNATION	UT	CODE	PPHT (€)
375.0003.19	COUDE NU FILETE MM LAITON BRUT 12X17	U	30584.7	4,25
375.0003.68	COUDE NU FILETE MM LAITON BRUT 15X21	U	30585.4	4,90
375.0006.10	COUDE NU FILETE MM LAITON BRUT 20X27	U	30582.1	8,13
375.0009.70	COUDE NU FILETE MM LAITON BRUT 26X34	U	27669.1	12,94
375.0030.20	COUDE NU FILETE MM LAITON BRUT 33X42	U	09611.5	40,27
375.0042.50	COUDE NU FILETE MM LAITON BRUT 40X49	U	07572.1	56,66
375.0067.30	COUDE NU FILETE MM LAITON BRUT 50X60	U	07608.3	89,74



COUDE

MF - Réduit - 90° - Brut



	DÉSIGNATION	UT	CODE	PPHT (€)
375.0008.98	COUDE NU FILETE RED.MF LAITON BRUT 15/20	U	17744.4	11,98

CUIVRE ET LAITON

RACCORDS LAITON A VISSER



TE

FFF - Brut



	DÉSIGNATION	UT	CODE	PPHT (€)
375.0004.39	TE FEMELLE LAITON BRUT 12X17	U	23919.4	5,85
375.0005.42	TE FEMELLE LAITON BRUT 15X21	U	23896.4	7,23
375.0008.50	TE FEMELLE LAITON BRUT 20X27	U	23897.2	11,33
375.0015.82	TE FEMELLE LAITON BRUT 26X34	U	09615.6	21,10
375.0030.54	TE FEMELLE LAITON BRUT 33X42	U	05782.8	40,72
375.0047.48	TE FEMELLE LAITON BRUT 40X49	U	05783.6	63,31
375.0080.66	TE FEMELLE LAITON BRUT 50X60	U	05784.4	107,55



TE

MMM - Brut



	DÉSIGNATION	UT	CODE	PPHT (€)
375.0003.83	TE NU FILETE LAITON BRUT 12X17	U	30578.9	5,11
375.0004.39	TE NU FILETE LAITON BRUT 15X21	U	30579.7	5,85
375.0007.30	TE NU FILETE LAITON BRUT 20X27	U	30580.5	9,73
375.0011.68	TE NU FILETE LAITON BRUT 26X34	U	32762.7	15,57
375.0035.11	TE NU FILETE LAITON BRUT 33X42	U	51332.5	46,81
375.0057.74	TE NU FILETE LAITON BRUT 40X49	U	07578.8	76,98
375.0113.05	TE NU FILETE LAITON BRUT 50X60	U	07586.1	150,73



MANCHON

FF - Egal avec butée - Brut

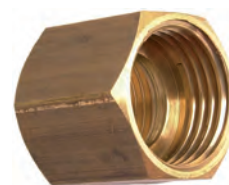

	DÉSIGNATION	UT	CODE	PPHT (€)
375.0016.95	MANCHON FF EGAL AV.BUTEE LAITON BRUT 33X42	U	09593.5	22,60



MANCHON

FF - Egal sans butée - Brut



	DÉSIGNATION	UT	CODE	PPHT (€)
375.0001.74	MANCHON FF SANS BUTEE LAITON BRUT 12X17	U	62951.9	2,32
375.0002.07	MANCHON FF SANS BUTEE LAITON BRUT 15X21	U	62952.7	2,76
375.0003.40	MANCHON FF SANS BUTEE LAITON BRUT 20X27	U	62953.5	4,54
375.0005.31	MANCHON FF SANS BUTEE LAITON BRUT 26X34	U	06015.2	7,08
375.0013.40	MANCHON FF SANS BUTEE LAITON BRUT 33X42	U	44478.6	17,86
375.0033.75	MANCHON FF SANS BUTEE LAITON BRUT 50X60	U	41250.2	45,00
375.0019.03	MANCHON FF SANS BUTEE LAITON BRUT 40X49	U	44471.1	25,37

CUIVRE ET LAITON

RACCORDS LAITON A VISSER



MANCHON

FF - Réduit - Brut



	DÉSIGNATION	UT	CODE	PPHT (€)
375.0003.02	MANCHON FF REDUIT LAITON BRUT 15X12	U	05995.6	4,02
375.0005.66	MANCHON FF REDUIT LAITON BRUT 20X12	U	71923.7	7,55
375.0014.82	MANCHON FF REDUIT LAITON BRUT 26X15	U	71924.5	19,76
375.0006.29	MANCHON FF REDUIT LAITON BRUT 26X20	U	05997.2	8,39
375.0003.87	MANCHON FF REDUIT LAITON BRUT 20X15	U	05996.4	5,16
375.0035.90	MANCHON FF REDUIT LAITON BRUT 50X40	U	40186.7	47,87



MANCHON

MF - Réduit - Chromé



	DÉSIGNATION	UT	CODE	PPHT (€)
375.0004.39	MAMELON MF REDUIT F. LAITON CHR M1/2X3/8	U	51539.5	5,85



MANCHON

MF - Réduit - Brut



	DÉSIGNATION	UT	CODE	PPHT (€)
375.0001.59	MAMELON MF REDUIT F. LAITON BRUT M12XF8	U	34972.0	2,12
375.0002.31	MAMELON MF REDUIT F. LAITON BRUT M15XF8	U	11553.5	3,85
375.0001.58	MAMELON MF REDUIT F. LAITON BRUT M15XF12	U	34244.4	2,11
375.0003.88	MAMELON MF REDUIT F. LAITON BRUT M20XF12	U	51347.3	5,18
375.0002.25	MAMELON MF REDUIT F. LAITON BRUT M20XF15	U	34246.9	3,00
375.0014.00	MAMELON MF REDUIT F. LAITON BRUT M26XF12	U	1402A.0	23,34
375.0006.02	MAMELON MF REDUIT F. LAITON BRUT M26XF15	U	07001.1	8,03
375.0004.74	MAMELON MF REDUIT F. LAITON BRUT M26XF20	U	51349.9	6,32
375.0010.54	MAMELON MF REDUIT F. LAITON BRUT M33XF20	U	27410.0	14,06
375.0009.29	MAMELON MF REDUIT F. LAITON BRUT M33XF26	U	35218.7	12,39
375.0034.72	MAMELON MF REDUIT F. LAITON BRUT M40XF20	U	43357.3	46,29
375.0017.30	MAMELON MF REDUIT F. LAITON BRUT M40XF26	U	66810.3	23,06
375.0011.84	MAMELON MF REDUIT F. LAITON BRUT M40XF33	U	63685.2	15,78
375.0031.28	MAMELON MF REDUIT F. LAITON BRUT M50XF33	U	43370.6	41,71
375.0025.72	MAMELON MF REDUIT F. LAITON BRUT M50XF40	U	27412.6	34,29
375.0125.00	MAMELON MF REDUIT F. LAITON BRUT M66XF50	U	16691.1	166,66

CUIVRE ET LAITON

RACCORDS LAITON A VISSER



MANCHON

FM - Réduit - Chromé



	DÉSIGNATION	UT	CODE	PPHT (€)
375.0006.13	MAMELON MF REDUIT M. LAITON CHR F20XM15	U	34252.7	8,17



MANCHON

FM - Réduit - Brut



	DÉSIGNATION	UT	CODE	PPHT (€)
375.0002.91	MAMELON MF REDUIT M. LAITON BRUT F12XM5	U	33813.7	3,88
375.0001.64	MAMELON MF REDUIT M. LAITON BRUT F12XM8	U	51535.3	2,18
375.0001.96	MAMELON MF REDUIT M. LAITON BRUT F15XM12	U	05620.0	2,61
375.0003.43	MAMELON MF REDUIT M. LAITON BRUT F20XM12	U	05622.6	4,57
375.0003.29	MAMELON MF REDUIT M. LAITON BRUT F20XM15	U	05621.8	4,39
375.0005.92	MAMELON MF REDUIT M. LAITON BRUT F26XM15	U	51348.1	7,89
375.0005.30	MAMELON MF REDUIT M. LAITON BRUT F26XM20	U	05650.7	7,06
375.0012.40	MAMELON MF REDUIT M. LAITON BRUT F33XM20	U	73583.7	16,53
375.0040.16	MAMELON MF REDUIT M. LAITON BRUT F40XM20	U	48872.6	53,55
375.0010.10	MAMELON MF REDUIT M. LAITON BRUT F33XM26	U	34253.5	13,47
375.0015.59	MAMELON MF REDUIT M. LAITON BRUT F40XM26	U	66809.5	20,79
375.0013.59	MAMELON MF REDUIT M. LAITON BRUT F40XM33	U	05651.5	18,12
375.0042.26	MAMELON MF REDUIT M. LAITON BRUT F50XM33	U	22403.0	56,35
375.0033.55	MAMELON MF REDUIT M. LAITON BRUT F50XM40	U	52583.2	44,73
375.0057.55	MAMELON MF REDUIT M. LAITON BRUT F66XM50	U	15996.2	159,86



MAMELON

MF - Egal - Brut



	DÉSIGNATION	UT	CODE	PPHT (€)
375.0002.19	MAMELON MF EGAL LAITON BRUT 15X21	U	05617.6	2,92
375.0001.40	MAMELON MF EGAL LAITON BRUT 12X17	U	05616.8	1,87
375.0003.20	MAMELON MF EGAL LAITON BRUT 20X27	U	05618.4	4,27
375.0005.96	MAMELON MF EGAL LAITON BRUT 26X34	U	05619.2	7,94
375.0009.79	MAMELON MF EGAL LAITON BRUT 33X42	U	35692.3	13,05
375.0013.89	MAMELON MF EGAL LAITON BRUT 40X49	U	05648.1	18,52
375.0029.91	MAMELON MF EGAL LAITON BRUT 50X60	U	05649.9	39,88

CUIVRE ET LAITON

RACCORDS LAITON A VISSER



MAMELON

MF - Egal - Chromé



	DÉSIGNATION	UT	CODE	PPHT (€)
375.0004.54	MAMELON MF EGAL LAITON CHR 12X17	U	35693.1	6,05



MAMELON

MM - Egal - Chromé



	DÉSIGNATION	UT	CODE	PPHT (€)
375.0003.44	MAMELON MM EGAL LAITON CHR 15X21	U	34241.0	4,58
375.0004.28	MAMELON MM EGAL LAITON CHR 20X27	U	34242.8	5,71



MAMELON

MM - Egal - Brut



	DÉSIGNATION	UT	CODE	PPHT (€)
375.0001.22	MAMELON MM EGAL LAITON BRUT 8X13	U	05623.4	1,62
375.0001.17	MAMELON MM EGAL LAITON BRUT 12X17	U	05624.2	1,56
375.0001.67	MAMELON MM EGAL LAITON BRUT 15X21	U	05625.9	2,23
375.0002.50	MAMELON MM EGAL LAITON BRUT 20X27	U	05626.7	3,34
375.0004.63	MAMELON MM EGAL LAITON BRUT 26X34	U	05627.5	6,17
375.0008.37	MAMELON MM EGAL LAITON BRUT 33X42	U	05628.3	11,16
375.0012.01	MAMELON MM EGAL LAITON BRUT 40X49	U	34254.3	16,01
375.0022.40	MAMELON MM EGAL LAITON BRUT 50X60	U	34255.0	29,87
375.0074.89	MAMELON MM EGAL LAITON BRUT 66X76	U	15461.0	99,85



MAMELON

MM - Réduit - Chromé



	DÉSIGNATION	UT	CODE	PPHT (€)
375.0003.52	MAMELON MM REDUIT LAITON CHR 15X12	U	34238.6	4,70
375.0004.74	MAMELON MM REDUIT LAITON CHR 20X15	U	34234.5	6,32

CUIVRE ET LAITON

RACCORDS LAITON A VISSER



MAMELON

MM - Réduit - Brut



	DÉSIGNATION	UT	CODE	PPHT (€)
375.0001.88	MAMELON MM REDUIT LAITON BRUT 15X12	U	34259.2	2,51
375.0001.56	MAMELON MM REDUIT LAITON BRUT 12X8	U	34237.8	2,08
375.0003.37	MAMELON MM REDUIT LAITON BRUT 20X12	U	43190.8	4,49
375.0002.84	MAMELON MM REDUIT LAITON BRUT 20X15	U	34233.7	3,78
375.0019.78	MAMELON MM REDUIT LAITON BRUT 26X12	U	75102.4	32,96
375.0005.38	MAMELON MM REDUIT LAITON BRUT 26X15	U	34235.2	7,18
375.0005.18	MAMELON MM REDUIT LAITON BRUT 26X20	U	34236.0	6,90
375.0011.42	MAMELON MM REDUIT LAITON BRUT 33X20	U	43580.0	15,23
375.0010.15	MAMELON MM REDUIT LAITON BRUT 33X26	U	34240.2	13,53
375.0024.02	MAMELON MM REDUIT LAITON BRUT 40X20	U	14084.1	40,03
375.0015.43	MAMELON MM REDUIT LAITON BRUT 40X26	U	66811.4	20,57
375.0014.66	MAMELON MM REDUIT LAITON BRUT 40X33	U	35220.3	19,55
375.0038.25	MAMELON MM REDUIT LAITON BRUT 50X33	U	78056.9	51,00
375.0026.60	MAMELON MM REDUIT LAITON BRUT 50X40	U	52584.0	35,46



REDUCTION

MF - A collerette - Brut



	DÉSIGNATION	UT	CODE	PPHT (€)
375.0001.21	REDUCTION A COLLERETTE LAITON BRUT M12XF8	U	09779.0	1,61
375.0002.92	REDUCTION A COLLERETTE LAITON BRUT M15XF8	U	30480.8	3,89
375.0001.16	REDUCTION A COLLERETTE LAITON BRUT M15XF12	U	63659.7	1,55
375.0002.03	REDUCTION A COLLERETTE LAITON BRUT M20XF15	U	63660.5	2,71
375.0003.35	REDUCTION A COLLERETTE LAITON BRUT M26XF20	U	63669.6	4,47
375.0006.66	REDUCTION A COLLERETTE LAITON BRUT M33XF26	U	11360.5	8,88



REDUCTION

MF - Avec butée - Chromé



	DÉSIGNATION	UT	CODE	PPHT (€)
375.0003.32	REDUCTION A BUTEE INT. LAITON CHR M15XF12	U	73809.6	4,43
375.0004.05	REDUCTION A BUTEE INT. LAITON CHR M20XF15	U	73791.6	5,40



REDUCTION

MF - Avec butée - Brut



	DÉSIGNATION	UT	CODE	PPHT (€)
375.0004.79	REDUCTION A BUTEE INT. LAITON BRUT M12XF8	U	07233.0	6,39

CUIVRE ET LAITON

RACCORDS LAITON A VISSER



REDUCTION

MF - Avec butée - Brut
- suite



	DÉSIGNATION	UT	CODE	PPHT (€)
375.0001.15	REDUCTION A BUTEE INT. LAITON BRUT M15XF12	U	53700.1	1,53
375.0001.74	REDUCTION A BUTEE INT. LAITON BRUT M20XF15	U	73621.5	2,32
375.0003.70	REDUCTION A BUTEE INT. LAITON BRUT M26XF20	U	73808.8	4,94



REDUCTION

MF - Réduit - Chromé



	DÉSIGNATION	UT	CODE	PPHT (€)
375.0004.60	MAMELON MF REDUIT M. LAITON CHR F15XM12	U	35687.3	6,14



BOUCHON

Mâle - Brut



	DÉSIGNATION	UT	CODE	PPHT (€)
375.0001.00	BOUCHON MALE LAITON BRUT 8X13	U	10211.1	1,33
375.0001.02	BOUCHON MALE LAITON BRUT 12X17	U	63676.1	1,36
375.0001.54	BOUCHON MALE LAITON BRUT 15X21	U	63677.9	2,06
375.0002.74	BOUCHON MALE LAITON BRUT 20X27	U	63678.7	3,65
375.0005.31	BOUCHON MALE LAITON BRUT 26X34	U	74112.4	7,08
375.0010.48	BOUCHON MALE LAITON BRUT 33X42	U	50188.2	13,97
375.0017.56	BOUCHON MALE LAITON BRUT 40X49	U	51032.1	23,41
375.0033.46	BOUCHON MALE LAITON BRUT 50X60	U	51055.2	44,62



BOUCHON

Femelle - Brut



	DÉSIGNATION	UT	CODE	PPHT (€)
375.0000.94	BOUCHON FEMELLE LAITON BRUT 12X17	U	63679.5	1,25
375.0001.52	BOUCHON FEMELLE LAITON BRUT 15X21	U	63680.3	2,02
375.0002.54	BOUCHON FEMELLE LAITON BRUT 20X27	U	63681.1	3,39
375.0005.11	BOUCHON FEMELLE LAITON BRUT 26X34	U	63699.3	6,81
375.0010.67	BOUCHON FEMELLE LAITON BRUT 33X42	U	01509.9	14,23
375.0016.09	BOUCHON FEMELLE LAITON BRUT 40X49	U	50995.0	21,45
375.0035.98	BOUCHON FEMELLE LAITON BRUT 50X60	U	75064.6	47,98

CUIVRE ET LAITON

RACCORDS LAITON A VISSER



ECROU

Contre écrou - A plateau - Brut



	DÉSIGNATION	UT	CODE	PPHT (€)
375.0001.40	CONTRE ECROU A PLATEAU LAITON BRUT 12X17	U	30042.6	1,86
375.0001.75	CONTRE ECROU A PLATEAU LAITON BRUT 15X21	U	23301.5	2,33
375.0003.92	CONTRE ECROU A PLATEAU LAITON BRUT 20X27	U	23311.4	5,22
375.0006.95	CONTRE ECROU A PLATEAU LAITON BRUT 26X34	U	74215.5	9,27



ECROU

6 pans CB - Brut



	DÉSIGNATION	UT	CODE	PPHT (€)
375.0000.99	ECROU 6 PANS CB LAITON BRUT 10 12X17	U	05573.1	1,32
375.0000.97	ECROU 6 PANS CB LAITON BRUT 12 12X17	U	05574.9	1,29
375.0001.78	ECROU 6 PANS CB LAITON BRUT 10 15X21	U	05575.6	2,38
375.0001.28	ECROU 6 PANS CB LAITON BRUT 12 15X21	U	05576.4	1,71
375.0001.26	ECROU 6 PANS CB LAITON BRUT 14 15X21	U	05577.2	1,68
375.0001.36	ECROU 6 PANS CB LAITON BRUT 16 15X21	U	05578.0	1,81
375.0003.56	ECROU 6 PANS CB LAITON BRUT 12 20X27	U	05580.6	4,75
375.0002.50	ECROU 6 PANS CB LAITON BRUT 14 20X27	U	05581.4	3,34
375.0002.19	ECROU 6 PANS CB LAITON BRUT 16 20X27	U	05582.2	2,92
375.0002.16	ECROU 6 PANS CB LAITON BRUT 18 20X27	U	05583.0	2,88
375.0003.24	ECROU 6 PANS CB LAITON BRUT 20 20X27	U	05584.8	4,32
375.0004.00	ECROU 6 PANS CB LAITON BRUT 22 26X34	U	05588.9	5,34



RACCORD

2 pièces compteur - Brut



	DÉSIGNATION	UT	CODE	PPHT (€)
375.0004.88	RACCORD COMPTEUR 2P.LAIT.BRUT 3/4"-1/2"	U	31993.9	6,51
375.0010.10	RACCORD AVANT COMPTEUR 2P.LAIT.BRUT 3/4"-3/4"	U	74396.3	13,47
375.0008.99	RACCORD COMPTEUR 2P.LAIT.BRUT 1"-3/4"	U	31994.7	11,99
375.0026.22	RACCORD COMPTEUR 2P.LAIT.BRUT 1"1/4-1"	U	23542.4	34,96
375.0037.94	RACCORD COMPTEUR 2P.LAIT.BRUT 1"1/2-1"1/4	U	71121.8	50,59
375.0061.64	RACCORD COMPTEUR 2P.LAIT.BRUT 2"-1"1/2	U	30838.7	82,18



TUBE FILETE

Brut



	DÉSIGNATION	UT	CODE	PPHT (€)
375.0011.86	TUBE FILETE 50MM LAITON BRUT 3/8	U	2988C.6	15,82

CUIVRE ET LAITON

RACCORDS LAITON A VISSER



TUBE FILETE

Brut
- suite



	DÉSIGNATION	UT	CODE	PPHT (€)
375.0013.57	TUBE FILETE 50MM LAITON BRUT 3/4	U	71369.3	18,09
375.0011.28	TUBE FILETE 50MM LAITON BRUT 1/2	U	8065C.9	15,04
375.0010.60	TUBE FILETE 100MM LAITON BRUT 1/2	U	50127.0	14,13
375.0023.66	TUBE FILETE 100MM LAITON BRUT 1"	U	50137.9	31,54
375.0018.09	TUBE FILETE 100MM LAITON BRUT 3/4	U	50136.1	24,12
375.0116.29	TUBE FILETE 1M LAITON BRUT 1/2	U	05796.8	155,05
375.0162.31	TUBE FILETE 1M LAITON BRUT 3/4	U	05797.6	216,41



RACCORD MACHINE A LAVER

Applique double chromée - Easy



	DÉSIGNATION	UT	CODE	PPHT (€)
276.0034.05	APPLIQUE EASY NIKELEE F1/2 1674	U	92180.9	52,38
276.0030.67	APPLIQUE EASY LAITON F1/2 SACHET+CAV. 1654	U	9217X.3	47,18



BAGUE REDUCTION

MF - 241 - Brut - 6 pans - D065



	DÉSIGNATION	UT	CODE	PPHT (€)
375.0046.87	BAGUE RED.6PANS BRUT M2*XF1/2 D065061	U	8314F.1	85,21
375.0020.26	BAGUE RED.6PANS BRUT M1*1/2XF1/2 D065051	U	8090A.2	40,52



MANCHON

FF - sans butée - 270 - Brut - D080



	DÉSIGNATION	UT	CODE	PPHT (€)
375.0346.39	MANCHON SS BUTEE 270 FEM. BRUT 2*1/2 D08010B	U	9457F.6	346,39



RACCORD

FF - Erou tournant - Brut - D095



	DÉSIGNATION	UT	CODE	PPHT (€)
375.0007.30	RACCORD DBL.FEM.+2ECR.TOURN.1/2" D09502B	U	79670.6	9,73
375.0009.96	RACCORD DBL.FEM.+2ECR.TOURN.3/4" D09503B	U	79671.4	13,28

CUIVRE ET LAITON

RACCORDS LAITON A VISSER



RACCORD UNION

MF - Droit - Sphéro-conique - D153



	DÉSIGNATION	UT	CODE	PPHT (€)
375.0009.51	UNION DROITE MF JSC BRUT 3/8" D15302B	U	0003F.4	12,68
375.0011.19	UNION DROITE MF JSC BRUT 1/2" D15303B	U	0003J.7	14,92
375.0015.63	UNION DROITE MF JSC BRUT 3/4" D15304B	U	0003L.3	20,84
375.0027.28	UNION DROITE MF JSC BRUT 1" D15305B	U	0004C.0	36,37
375.0045.12	UNION DROITE MF JSC BRUT 1*1/4 D15306B	U	3232L.0	60,16
375.0089.57	UNION DROITE MF JSC BRUT 1*1/2 D15307B	U	32330.3	119,43
375.0151.57	UNION DROITE MF JSC BRUT 2" D15308B	U	32331.1	202,09
375.0351.52	UNION DROITE MF JSC BRUT 2*1/2 D15309B	U	5866C.6	468,70



RACCORD EXPRESS

Cannelé à collerette - 2280 - Joint NBR monté



	DÉSIGNATION	UT	CODE	PPHT (€)
372.0004.48	RACCORD EXPRESS AV.JT MONTE CANN.C. 9 2280009	U	87231.7	5,97
372.0004.78	RACCORD EXPRESS AV.JT MONTE CANN.C.11 2280011	U	87240.8	6,37
372.0005.83	RACCORD EXPRESS AV.JT MONTE CANN.C.16 2280016	U	76594.1	7,77
372.0006.05	RACCORD EXPRESS AV.JT MONTE CANN.C.19 2280019	U	76512.3	8,07
372.0006.52	RACCORD EXPRESS AV.JT MONTE CANN.C.25 2280025	U	87266.3	8,70



RACCORD EXPRESS

Mâle - 2281 - Joint NBR monté



	DÉSIGNATION	UT	CODE	PPHT (€)
372.0004.66	RACCORD EXPRESS AV.JT MONTE MALE 1/2 2281004	U	76515.6	6,22
372.0004.91	RACCORD EXPRESS AV.JT MONTE MALE 3/4 2281005	U	76518.0	6,55
372.0005.72	RACCORD EXPRESS AV.JT MONTE MALE 1" 2281006	U	87285.3	7,62



RACCORD EXPRESS

Femelle - 2282 - Joint NBR monté



	DÉSIGNATION	UT	CODE	PPHT (€)
372.0004.58	RACCORD EXPRESS AV.JT MONTE FEM. 1/2 2282004	U	76528.9	6,10
372.0004.99	RACCORD EXPRESS AV.JT MONTE FEM. 3/4 2282005	U	76533.9	6,65

CUIVRE ET LAITON

RACCORDS LAITON A VISSER



APPLIQUE TRAVERSEE DE CLOISON POUR ROBINETTERIE

Avec applique démontable adaptable à tous types de raccords pour PER



	DÉSIGNATION	UT	CODE	PPHT (€)	ECOPART (€)
430.0021.26	APPLIQUE ROB. JARDIN LAITON D.1/2 006503	U	0207C.5	28,35	0,01

RACCORDS LAITON RAPIDE



TE A COMPRESSION

FFF - Egal - Olive laiton



	DÉSIGNATION	UT	CODE	PPHT (€)
375.0011.21	TE A BICONE LAITON -CARTE- 12	U	08915.1	14,95
375.0016.12	TE A BICONE LAITON -CARTE- 14	U	08947.4	21,49
375.0033.98	TE A BICONE LAITON -CARTE- 18	U	3597K.1	45,30



RACCORD UNION A COMPRESSION

FF - Double égal - Olive laiton



	DÉSIGNATION	UT	CODE	PPHT (€)
375.0021.29	RAC.DOUBLE A BICONE LAITON -CARTE- 18	U	36176.4	28,39
375.0010.84	RAC.DOUBLE A BICONE LAITON -CARTE- 1/2 14X14	U	08907.8	14,46
375.0010.48	RAC.DOUBLE A BICONE LAITON -CARTE- 1/2 16X16	U	08910.2	13,97
375.0008.50	RAC.DOUBLE A BICONE LAITON -CARTE- 1/4 8	U	09155.3	11,34
375.0006.96	RAC.DOUBLE A BICONE LAITON -CARTE- 3/8 10X10	U	08898.9	9,28
375.0007.61	RAC.DOUBLE A BICONE LAITON -CARTE- 3/8 10X12	U	05936.0	10,15
375.0007.56	RAC.DOUBLE A BICONE LAITON -CARTE- 3/8 12X12	U	08904.5	10,08



RACCORD UNION A COMPRESSION

MF - Fer/cuivre - Olive laiton



	DÉSIGNATION	UT	CODE	PPHT (€)
375.0027.91	RAC.FC MALE A BICONE LAITON 22 20X27	U	02244.2	27,91
375.0011.40	RAC.FC MALE A BICONE LAITON -CARTE- 10 1/4"	U	08818.7	15,20
375.0007.85	RAC.FC MALE A BICONE LAITON -CARTE- 6 1/4"	U	08884.9	10,47
375.0008.24	RAC.FC MALE A BICONE LAITON -CARTE- 12 1/2"	U	08891.4	10,98
375.0008.03	RAC.FC MALE A BICONE LAITON -CARTE- 16 1/2"	U	08913.6	10,71
375.0011.06	RAC.FC MALE A BICONE LAITON -CARTE- 14 3/8"	U	08981.3	14,74
375.0006.10	RAC.FC MALE A BICONE LAITON -CARTE- 10 3/8"	U	25485.4	8,13
375.0006.16	RAC.FC MALE A BICONE LAITON -CARTE- 12 3/8"	U	25488.8	8,21

CUIVRE ET LAITON

RACCORDS LAITON RAPIDE



RACCORD UNION A COMPRESSION

MF - Fer/cuivre - Olive laiton
- suite



	DÉSIGNATION	UT	CODE	PPHT (€)
375.0007.49	RAC.FC MALE A BICONE LAITON -CARTE- 14 1/2"	U	25493.8	9,99
375.0011.00	RAC.FC MALE A BICONE LAITON -CARTE- 15 1/2"	U	3597E.2	14,67
375.0014.74	RAC.FC MALE A BICONE LAITON -CARTE- 18 3/4"	U	3597F.0	19,65
375.0021.49	RAC.FC MALE A BICONE LAITON 20 3/4"	U	3597G.8	28,65



RACCORD UNION A COMPRESSION

FF - Fer/Cuivre - Olive laiton



	DÉSIGNATION	UT	CODE	PPHT (€)
375.0009.16	RAC.FC FEM.A BICONE LAITON -CARTE- 6 1/4"	U	09099.3	12,22
375.0008.26	RAC.FC FEM.A BICONE LAITON -CARTE- 10 3/8"	U	08892.2	11,02
375.0009.26	RAC.FC FEM.A BICONE LAITON -CARTE- 12 1/2"	U	08895.5	12,35
375.0008.26	RAC.FC FEM.A BICONE LAITON -CARTE- 12 3/8"	U	25503.4	11,02
375.0009.40	RAC.FC FEM.A BICONE LAITON -CARTE- 14 1/2"	U	08897.1	12,54
375.0014.90	RAC.FC FEM.A BICONE LAITON -CARTE- 18 3/4"	U	3617F.6	19,87
375.0010.54	RAC.FC FEM.A BICONE LAITON -CARTE- 16 1/2"	U	09018.3	14,06



CLIP DE DEMONTAGE TECTITE CLASSIQUE

Type 405



	DÉSIGNATION	UT	CODE	PPHT (€)
030.0002.15	CLIP DE DEMONTAGE T509 TECTITE 12 4752297	U	63379.2	3,71
030.0002.15	CLIP DE DEMONTAGE T509 TECTITE 14 4752299	U	63391.7	3,71
030.0002.15	CLIP DE DEMONTAGE T509 TECTITE 16 4752310	U	63393.3	3,71
030.0002.15	CLIP DE DEMONTAGE T509 TECTITE 18 4752319	U	63845.2	3,71
030.0002.15	CLIP DE DEMONTAGE T509 TECTITE 22 4752321	U	63394.1	3,71



MANCHON TECTITE CLASSIQUE

MF - Réduit - T243G - Démontable



	DÉSIGNATION	UT	CODE	PPHT (€)
030.0009.89	MANCHON MF 12-1/2 TECTITE 4751417	U	86091.6	17,06
030.0007.89	MANCHON MF 14-1/2 TECTITE 4751555	U	63295.0	13,60
030.0009.94	MANCHON MF 16-1/2 TECTITE 4751557	U	63305.7	17,14
030.0014.15	MANCHON MF 18-1/2 TECTITE 4751472	U	86114.6	24,40
030.0013.47	MANCHON MF 22-3/4 TECTITE 4751516	U	63307.3	23,22

Le PPHT comprend l'ecopart (€)

CUIVRE ET LAITON

RACCORDS LAITON RAPIDE



INSERT TECTITE CLASSIQUE PEX-PB - 0382



	DÉSIGNATION	UT	CODE	PPHT (€)
030.0001.24	INSERT TECTITE CLASSIC PEX-PB 12 4753221	U	2866Z.9	2,13
030.0001.56	INSERT TECTITE CLASSIC PEX-PB 16 4753232	U	286A9.5	2,69



Watts Water Technologies EMEA

COLLET MOBILE

Joint caoutchouc + bague inox



	DÉSIGNATION	UT	CODE	PPHT (€)	ECOPART(€)
920.0026.92	COLLET MOBILE GRIPP-CARTE20- 10X3/8 001004	U	41790.7	35,89	0,00
920.0030.89	COLLET MOBILE GRIPP-CARTE20- 10X1/2 001006	U	40031.7	41,19	0,00
920.0030.89	COLLET MOBILE GRIPP-CARTE20- 12X1/2 001007	U	40032.5	41,19	0,00
920.0030.89	COLLET MOBILE GRIPP-CARTE20- 14X1/2 001008	U	40030.9	41,19	0,00
920.0039.02	COLLET MOBILE GRIPP-CARTE20- 16X3/4 001012	U	40026.7	52,02	0,00
920.0039.02	COLLET MOBILE GRIPP-CARTE20- 18X3/4 001013	U	40027.5	52,02	0,00
920.0039.02	COLLET MOBILE GRIPP-CARTE20-18X20-20X27001014	U	40028.3	52,02	0,00
920.0039.02	COLLET MOBILE GRIPP-CARTE20- 14X3/4 001009	U	74583.6	52,02	0,00
920.0019.63	COLLET MOBILE GRIPP-CARTE10- 22X1 001044	U	75280.8	26,17	0,00



Watts Water Technologies EMEA

RACCORD S2

A serrage - Avec écrou + bague inox et joint Gripp intégrés (barrette de 10) - Brut



	DÉSIGNATION	UT	CODE	PPHT (€)	ECOPART(€)
375.0038.50	RACCORD GRIPP S2 3/8 CU 10-BARET 10P-23001121	U	38956.9	51,34	0,01
375.0045.26	RACCORD GRIPP S2 1/2 CU 12-BARET 10P-23001123	U	39008.8	60,35	0,01
375.0045.26	RACCORD GRIPP S2 1/2 CU 14-BARET 10P-23001124	U	39078.1	60,35	0,01
375.0065.02	RACCORD GRIPP S2 3/4 CU 14-BARET 10P-23001126	U	39184.7	86,71	0,01
375.0065.02	RACCORD GRIPP S2 3/4 CU 16-BARET 10P-23001128	U	39211.8	86,71	0,01
375.0065.02	RACCORD GRIPP S2 3/4 CU 18-BARET 10P-23001129	U	39227.4	86,71	0,01

Pour plus d'infos,
consultez
le CAHIER TECHNIQUE
page 14

Le PPHT comprend l'ecopart (€)

COLLECTEUR ET ACCESSOIRES

COLLECTEUR SANITAIRE ET CHAUFFAGE



COLLECTEUR MF



	DÉSIGNATION	UT	CODE	PPHT (€)
378.0006.84	NOURRICE MF 3/4" 2 SORTIES M1/2"	U	5658Y.5	9,12
378.0011.80	NOURRICE MF 3/4" 3 SORTIES M1/2"	U	5659L.9	15,73
378.0014.90	NOURRICE MF 3/4" 4 SORTIES M1/2"	U	5659Q.1	19,87
378.0018.52	NOURRICE MF 3/4" 5 SORTIES M1/2"	U	5659S.7	24,69
378.0019.53	NOURRICE MF 3/4" 6 SORTIES M1/2"	U	5659U.2	26,04



ACCESSOIRE Support collecteur



	DÉSIGNATION	UT	CODE	PPHT (€)
276.0016.76	SUPPORT POUR COLLECTEUR D.22-34 -2- 1830	U	223F1.0	21,21



COLLECTEUR DISTRIGRIPP

Chauffage type B ø30 - Entraxe 55 mm - Arrivée Mâle - Sans piquage - Extrémité Femelle 1"



	DÉSIGNATION	UT	CODE	PPHT (€)	ECOPART(€)
378.0013.62	NOURRICE 2 DEPART MALE 1/2 TYPE BC 002001	U	1313C.4	18,17	0,01
378.0018.00	NOURRICE 3 DEPART MALE 1/2 TYPE BC 002002	U	70075.7	24,01	0,01
378.0023.87	NOURRICE 4 DEPART MALE 1/2 TYPE BC 002003	U	62745.5	31,84	0,01
378.0028.60	NOURRICE 5 DEPART MALE 1/2 TYPE BC 002004	U	43856.4	38,15	0,01
378.0036.68	NOURRICE 6 DEPART MALE 1/2 TYPE BC 002005	U	43891.1	48,91	0,01
378.0044.90	NOURRICE 3 DEPART MALE 3/4 TYPE BCA3 002031	U	1730K.3	59,88	0,01
378.0056.78	NOURRICE 4 DEPART MALE 3/4 TYPE BCA4 002032	U	1730L.1	75,71	0,01
378.0080.47	NOURRICE 5 DEPART MALE 3/4 TYPE BCA5 002033	U	1731D.6	107,30	0,01
378.0091.29	NOURRICE 6 DEPART MALE 3/4 TYPE BCA6 002034	U	1731E.3	121,73	0,01



COLLECTEUR DISTRIGRIPP

Sanitaire type A ø22 - Entraxe 50 mm - Arrivée Mâle



	DÉSIGNATION	UT	CODE	PPHT (€)	ECOPART(€)
378.0010.05	DISTRIBUTEUR GRIPP A 20 M3/4M1/2 001401	U	06953.4	13,41	0,01
378.0009.45	DISTRIBUTEUR GRIPP A 30 M3/4M1/2 001402	U	24068.9	12,61	0,01
378.0012.84	DISTRIBUTEUR GRIPP A 40 M3/4M1/2 001403	U	59799.7	17,13	0,01
378.0016.67	DISTRIBUTEUR GRIPP A 50 M3/4M1/2 001404	U	14774.4	22,24	0,01
378.0019.13	DISTRIBUTEUR GRIPP A 60 M3/4M1/2 001405	U	59800.3	25,52	0,01
378.0023.96	DISTRIBUTEUR GRIPP A 70 M3/4M1/2 001406	U	77995.9	31,95	0,01

COLLECTEUR ET ACCESSOIRES

COLLECTEUR SANITAIRE ET CHAUFFAGE



Watts Water Technologies EMEA

COLLECTEUR DISTRIGRIPP

Sanitaire/chauffage type Fc ø27 -
Entraxe 50 mm - Arrivée Mâle - Extrémité F 3/4"

	DÉSIGNATION	UT	CODE	PPHT (€)	ECOPART (€)
378.0036.96	NOURRICE 7 DEPART M 1/2 TYPE FC 003687	U	0993I.0	49,29	0,01



DISTRIBUTEUR

958



	DÉSIGNATION	UT	CODE	PPHT (€)	ECOPART (€)
430.0023.56	DISTRIBUTEUR MF 3/4 2 PIQ.1/2+VANN.GRK 958-1A	U	8375P.0	39,27	0,01
430.0032.70	DISTRIBUTEUR MF 3/4 3 PIQ.1/2+VANN.GRK 958-1B	U	5137U.4	54,51	0,01
430.0045.73	DISTRIBUTEUR MF 3/4 4 PIQ.1/2+VANN.GRK 958-1C	U	5141Y.0	76,23	0,01
430.0054.53	DISTRIBUTEUR MF 3/4 5 PIQ.1/2+VANN.GRK 958-1D	U	51424.0	90,89	0,01
430.0071.15	DISTRIBUTEUR MF 3/4 6 PIQ.1/2+VANN.GRK 958-1I	U	8375S.4	118,59	0,01



ACCESSOIRE COLLECTEUR

Support de fixation - Avec garniture isophonique



	DÉSIGNATION	UT	CODE	PPHT (€)	ECOPART (€)
375.0013.48	SUPPORT POUR COLLECTEUR 3/4" -PAIRE- SUP4	U	65280.0	17,98	

COLLECTEUR PLANCHER CHAUFFANT



COLLECTEUR

Collecteur compact - Prémonté



	DÉSIGNATION	UT	CODE	PPHT (€)	ECOPART (€)
590.0271.88	COLLECTEUR COMPACT 2 CIRCUITS 14707001001	U	218JH.1	319,93	0,07
590.0325.79	COLLECTEUR COMPACT 3 CIRCUITS 14707101001	U	218JN.0	383,36	0,08
590.0382.04	COLLECTEUR COMPACT 4 CIRCUITS 14707201001	U	218JJ.8	449,54	0,08
590.0435.96	COLLECTEUR COMPACT 5 CIRCUITS 14707301001	U	218JK.6	512,98	0,09
590.0489.86	COLLECTEUR COMPACT 6 CIRCUITS 14707401001	U	218JL.4	576,41	0,10
590.0543.78	COLLECTEUR COMPACT 7 CIRCUITS 14707501001	U	249XJ.5	639,84	0,10

COLLECTEUR ET ACCESSOIRES

COLLECTEUR PLANCHER CHAUFFANT



ACCESSOIRE COLLECTEUR

Eléments de collecteur - Pour tube
PER

	DÉSIGNATION	UT	CODE	PPHT (€)	ECOPART (€)
590.0009.75	BARRETTE DE FIXATION L.1M 12515061010	U	16867.4	11,48	0,01
590.0001.83	FIXATION UNIVERSELLE 12514861010	U	16879.9	2,16	0,01



ACCESSOIRE COLLECTEUR

Vanne de retour



	DÉSIGNATION	UT	CODE	PPHT (€)	ECOPART (€)
590.0020.02	VANNE DE RETOUR 5111002	U	4894D.3	26,71	0,01

Pour plus d'infos,
consultez
le CAHIER TECHNIQUE
page 14

PVC EVACUATION

TUBES ET RACCORDS PVC EVACUATION



TUBE PVC NF E + NF M1
DTU 60-32 et DTU 60-33 - EN 1453-1



	DÉSIGNATION	UT	CODE	PPHT (€)
259.0008.05	TUBE PVC EU NFE-NFM1 -2M- 40X3.0 (34)	U	98802.2	13,42
259.0008.59	TUBE PVC EU NFE-NFM1 -4M- 110X3.2 (103.6)	M	98787.5	14,31



CULOTTE
MF - 87°30 - Simple



	DÉSIGNATION	UT	CODE	PPHT (€)
266.0412.70	CULOTTE SIMPLE PVC EV 87.30 MF 315	U	0716N.7	550,27



MANCHON BLANC
Femelle - double



	DÉSIGNATION	UT	CODE	PPHT (€)
257.0006.85	MANCHON DOUBLE FEMELLE PVC BLANC 100	U	163NR.8	9,13



TUBE FLEXIBLE
First-Flex®



	DÉSIGNATION	UT	CODE	PPHT (€)
000.0006.09	TUBE FLEXIBLE EVAC.PVC SOUPLE TUBEFLEX1M32	U	9493C.9	9,09
000.0006.71	TUBE FLEXIBLE EVAC.PVC SOUPLE TUBEFLEX1M40	U	9493F.2	10,01
000.0009.00	TUBE FLEXIBLE EVAC.PVC SOUPLE TUBEFLEX1M50	U	9493H.8	13,44



COUDE A COLLER
FF - 22°30



	DÉSIGNATION	UT	CODE	PPHT (€)
256.0001.48	COUDE PVC EVAC.22 FF 40* CSG22040F	U	0556F.5	2,47
266.0007.90	COUDE PVC EVAC.22 FF 100* CSG22100F	U	5638L.5	13,17
256.0012.35	COUDE EVAC.22°30 FF D.125 PVC CSG22125F	U	6545U.8	20,59

PVC EVACUATION

TUBES ET RACCORDS PVC EVACUATION



COUDE A COLLER
MF - 22°30



	DÉSIGNATION	UT	CODE	PPHT (€)
256.0001.48	COUDE PVC EVAC.22 MF 40* CSG22040	U	0556H.1	2,47
273.0007.21	COUDE PVC EVAC.22 MF 100* CSG22100	U	5616I.6	12,01
256.0010.79	COUDE EVAC.22°30 MF D.125 PVC CSG22125	U	6545R.5	17,98



COUDE A COLLER
FF - 45°



	DÉSIGNATION	UT	CODE	PPHT (€)
266.0000.91	COUDE PVC EVAC.45 FF 32* CSG45032F	U	5746H.1	1,52
256.0003.35	COUDE PVC EVAC.45 FF 63 CSG45063F	U	8280Y.5	5,58
256.0003.53	COUDE FF 45° D.75MM CSG45075F	U	195KC.1	5,89
266.0005.01	COUDE FXF A 45 DIAM 80 MM CSG45080F	U	6533Q.1	8,35
266.0009.22	COUDE FF 45° D.110MM CSG45110F	U	195KE.6	15,37
266.0022.09	COUDE PVC EVAC.45 FF 160* CSG45160F	U	2504B.3	36,81



COUDE A COLLER
MF - 45°



	DÉSIGNATION	UT	CODE	PPHT (€)
266.0000.85	COUDE PVC EVAC.45 MF 32* CSG45032	U	5746G.3	1,41
256.0003.10	COUDE PVC EVAC.45 MF 63 CSG45063	U	8285W.4	5,16
256.0003.29	COUDE MXF A 45° D75MM - PVE EVAC CSG45075	U	195K1.5	5,48
266.0003.40	COUDE MXF A 45 DIAM 80 MM CSG45080	U	6533M.7	5,67
266.0015.24	COUDE PVC EVAC.45 MF 160* CSG45160	U	2504F.4	25,40
273.0022.27	COUDE PVC EVAC.45 MF 200* CSG45200	U	2504H.0	37,12



COUDE A COLLER
FF - 67°30



	DÉSIGNATION	UT	CODE	PPHT (€)
256.0001.07	COUDE PVC EVAC.67.30 FF 32* CSG67032F	U	9514L.6	1,78
256.0001.69	COUDE PVC EVAC.67.30 FF 40* CSG67040F	U	95153.3	2,81
266.0007.03	COUDE PVC EVAC.67.30 FF 100* CSG67100F	U	95154.1	11,71

PVC EVACUATION

TUBES ET RACCORDS PVC EVACUATION

COUDE A COLLER
MF - 67°30

	DÉSIGNATION	UT	CODE	PPHT (€)
256.0001.69	COUDE PVC EVAC.67.30 MF 40* CSG67040	U	9514J.0	2,81
256.0002.58	COUDE EVAC.67°30 MF D.50 PVC CSG67050	U	231CT.0	4,30
266.0005.63	COUDE PVC EVAC.67.30 MF 100* CSG67100	U	9514K.8	9,39

COUDE A COLLER
FF - 87°30

	DÉSIGNATION	UT	CODE	PPHT (€)
266.0000.98	COUDE PVC EVAC.87.30 FF 32* CSG87032F	U	57479.8	1,63
256.0003.86	COUDE PVC EVAC.87.30 FF 63 CSG87063F	U	82863.2	6,44
256.0003.99	COUDE EVAC.87°30 FF D.75 PVC CSG87075F	U	229WV.5	6,65
266.0005.01	COUDE FXF A 87°30 DIAM. 80 MM CSG87080F	U	6534P.2	8,35
266.0025.72	COUDE PVC EVAC.87.30 FF 160* CSG87160F	U	2504K.5	42,87

COUDE A COLLER
MF - 87°30

	DÉSIGNATION	UT	CODE	PPHT (€)
266.0000.85	COUDE PVC EVAC.87.30 MF 32* CSG87032	U	57474.9	1,41
266.0002.13	COUDE PVC EVAC.87.30 MF 50* CSG87050	U	5747D.9	3,55
256.0003.33	COUDE PVC EVAC. 87.30 MF 63 CSG87063	U	8285Y.0	5,55
256.0003.99	COUDE EVAC.87°30 MF D.75 PVC CSG87075	U	229WX.1	6,65
266.0008.51	COUDE PVC EVAC.87.30 MF 125* CSG87125	U	5747F.4	14,19
266.0015.63	COUDE PVC EVAC.87.30 MF 160* CSG87160	U	25051.4	26,05

CULOTTE A COLLER
FF - 45°

	DÉSIGNATION	UT	CODE	PPHT (€)
256.0002.25	CULOTTE PVC EVAC.45 FF 32* DSG45032F	U	5747L.3	3,75
256.0002.27	CULOTTE PVC EVAC.45 FF 40* DSG45040F	U	57486.3	3,78
266.0003.62	CULOTTE PVC EVAC.45 FF 50* DSG45050F	U	5748A.4	6,04
256.0006.98	CULOTTE PVC 45° FF63 DSG45063F	U	8284R.6	11,63
256.0006.91	CULOTTE SPLE PVC EVAC.45 FF DSG45075F	U	229WZ.8	11,52
266.0008.53	CULOTTE FXF A 45 DIAM. 80 MM DSG45080F	U	6535K.9	14,21
266.0009.34	CULOTTE PVC EVAC.45 FF 200* DSG45200F	U	86711.9	148,90

PVC EVACUATION

TUBES ET RACCORDS PVC EVACUATION

CULOTTE A COLLER
MF - 45°

	DÉSIGNATION	UT	CODE	PPHT (€)
256.0002.27	CULOTTE PVC EVAC.45 MF 32* DSG45032	U	5747K.5	3,78
256.0002.31	CULOTTE PVC EVAC.45 MF 40* DSG45040	U	57484.8	3,85
256.0003.62	CULOTTE PVC EVAC.45 MF 50* DSG45050	U	57487.1	6,04
256.0007.15	CULOTTE 45 MF SPLE PVC EVAC.75 DSG45075	U	229X0.7	11,92
266.0007.71	CULOTTE MXF A 45 DIAM. 80 MM DSG45080	U	65356.8	12,85
266.0036.23	CULOTTE PVC EVAC.45 MF 160* DSG45160	U	2505A.4	60,38

CULOTTE A COLLER
MF - Réduite - 45°

	DÉSIGNATION	UT	CODE	PPHT (€)
256.0009.56	CULOTTE REDUITE SPLE PVC EV.45 MF D100 DRG105	U	229X4.9	15,94

CULOTTE A COLLER
FF - 67°30

	DÉSIGNATION	UT	CODE	PPHT (€)
266.0012.77	CULOTTE PVC EVAC.67°30 FF 100* DSG67100F	U	9515E.8	21,28

CULOTTE A COLLER
MF - 67°30

	DÉSIGNATION	UT	CODE	PPHT (€)
266.0009.32	CULOTTE PVC EVAC.67°30 MF 100* DSG67100	U	9515D.1	15,53

CULOTTE A COLLER
FF - 87°30

	DÉSIGNATION	UT	CODE	PPHT (€)
256.0006.98	CULOTTE PVC 87.30 FF63 DSG87063F	U	82819.4	11,63
256.0007.31	CULOTTE SPLE PVC EVAC.87.30 FF 75 DSG87075F	U	229X1.5	12,18
266.0008.53	CULOTTE FXF A 87°30 DIAM. 80 MM DSG87080F	U	6537N.1	14,21
266.0017.76	CULOTTE PVC EVAC.87.30 FF 125* DSG87125F	U	58572.9	29,60
266.0041.66	CULOTTE PVC EVAC.87.30 FF 160* TSG87160F	U	25067.0	69,43

PVC EVACUATION

TUBES ET RACCORDS PVC EVACUATION



CULOTTE A COLLER
MF - 87°30



	DÉSIGNATION	UT	CODE	PPHT (€)
266.0007.71	CULOTTE MXF A 87 30 DIAM. 80 MM DSG87080	U	6537M.3	12,85
266.0011.79	CULOTTE PVC EVAC.87.30 MF 125* DSG87125	U	5856L.D	19,65



MANCHON A COLLER
FF - Butée



	DÉSIGNATION	UT	CODE	PPHT (€)
266.0000.48	MANCHON PVC EVACUATION FF 32* MFF032	U	5748G.1	0,80
266.0000.63	MANCHON PVC EVACUATION FF 40* MFF040	U	5748H.9	1,05
266.0001.01	MANCHON PVC EVACUATION FF 50* MFF050	U	5748I.7	1,69
256.0001.93	MANCHON PVC EVACUATION FF 63 MFF63	U	8281I.1	3,22
256.0003.12	MANCHON PVC EVAC. FF 75 MFF75	U	229XH.0	5,20
266.0002.31	MANCHON FXF DIAM. 80 MM MFF80	U	6552X.2	3,85
256.0005.08	MANCHON PVC EVAC. FF 110 MFF110	U	229XJ.7	8,47
266.0004.92	MANCHON PVC EVACUATION FF 125* MFF125	U	5748J.6	8,20



MANCHON A COLLER
FF - Coulisse



	DÉSIGNATION	UT	CODE	PPHT (€)
256.0002.88	COULISSE FXF DIAM.100MM CFF100	U	8461T.7	4,80



MANCHON A COLLER
MF - De dilatation



	DÉSIGNATION	UT	CODE	PPHT (€)
256.0007.03	MANCHON DE DILATATION DIAM.40 MD40	U	6524X.7	11,72
256.0007.36	MANCHON DILATATION D.50 MD50	U	3296P.7	12,27
256.0010.00	MANCHON DE DILATATION D.80 MD80	U	231D3.1	16,67
256.0013.25	MANCHON DE DILATATION D110 MF MD110	U	229X7.2	22,09
256.0015.13	MANCHON DE DILATATION MF 125* MD125	U	5748F.3	25,22

PVC EVACUATION

TUBES ET RACCORDS PVC EVACUATION



REDUCTION A COLLER
MF - Réduction excentrée



	DÉSIGNATION	UT	CODE	PPHT (€)
256.0002.55	REDUCTION EXCENTREE PVC EVAC.MF 40X32 ASG3240	U	229XN.9	4,25
256.0002.52	REDUCTION EXCENTREE PVC EVAC.MF 50X40 ASG4050	U	229XS.1	4,20
256.0004.61	REDUCTION EXCENTRE MF 100/40 ASG40100	U	8412T.7	7,69
256.0005.14	REDUCTION EXCENTREE PVC EV.MF 100X80 ASG80100	U	229XV.4	8,57
256.0005.15	REDUCTION EXCENTRE MF 100/50 ASG50100	U	8412U.4	8,59
256.0007.39	REDUCTION EXCENT.MF 125-100 ASG100125	U	4115W.9	12,31
256.0019.60	REDUCTION EXCENT.MF 160-100 ASG100160	U	4115X.7	32,66
256.0024.52	REDUCTION EXCENT.MF 200-160 ASG160200	U	4116L.9	40,86
256.0110.15	REDUCTION EXCENT.MF 315/200* ASG200315	U	6029H.7	183,59



REDUCTION A COLLER
MF - Réduction incorporée



	DÉSIGNATION	UT	CODE	PPHT (€)
256.0001.05	REDUCTION INCORPORÉE MXF 50-32 MM RC5032	U	6527N.3	1,75



TE A COLLER
FF - 87°30 - Pied de biche



	DÉSIGNATION	UT	CODE	PPHT (€)
256.0001.87	TE PIED DE BICHE 87.30 FF 32* TSG87032F	U	5749E.4	3,11



TE A COLLER
MF - 87°30 - Pied de biche



	DÉSIGNATION	UT	CODE	PPHT (€)
256.0002.03	TE PIED DE BICHE 87.30 MF 32* TSG87032	U	5749D.7	3,38
256.0003.62	TE PIED DE BICHE 87.30 MF 50* TSG87050	U	5749H.8	6,04
266.0036.19	TE PIED DE BICHE 87°30 MF D.160 TSG87160	U	170AD.2	60,32



TAMPON DE REDUCTION



	DÉSIGNATION	UT	CODE	PPHT (€)
256.0003.87	TAMPON REDUC.COLLER PVC EV MF 63X50 T65	U	229Y3.0	6,45
256.0003.79	TAMPON REDUC.COLLER PVC EV MF 75X40 T74	U	229Y4.8	6,32
256.0003.74	TAMPON REDUC.COLLER PVC EV MF 75X50 T75	U	229Y6.3	6,23

PVC EVACUATION

TUBES ET RACCORDS PVC EVACUATION



TAMPON DE REDUCTION



DÉSIGNATION	UT	CODE	PPHT (€)
256.0004.49 TAMPON DE REDUCTION 80/40 MM T84	U	6532W.9	7,49
256.0004.39 TAMPON DE REDUCTION 80/50 MM TAR08050	U	6532X.7	7,31
256.0004.65 TAMPON DE REDUCT.100/32MM* TAR10032	U	5748K.4	7,75
266.0004.49 TAMPON DE REDUCT.100/40MM* TAR10040	U	5748L.2	7,49
266.0004.39 TAMPON DE REDUCT.100/50MM* TAR10050	U	57495.4	7,32
256.0005.24 TAMPON REDUC.COLLER PVC EV MF 100X63 T106	U	229Y7.1	8,74
256.0004.18 TAMPON REDUC.COLLER PVC EV MF 100X75 T107	U	229Y8.9	6,96
256.0005.14 TAMPON DE REDUCT.100/80MM T108	U	22080.6	8,57
256.0004.39 TAMPON DE REDUCTION 100/40/32 MM TAR14032	U	2200V.1	7,32
256.0004.39 TAMPON DE REDUCT.100/40/40MM* TAR14040	U	5749C.9	7,32
256.0005.66 TAMPON DE REDUCTION D100/50/32MM T153	U	197RC.6	9,44
256.0004.65 TAMPON DE REDUCTION 100/50/40 MM TAR15040	U	6540X.7	7,75
256.0006.44 TAMPON REDUC.COLLER PVC EV MF 110X100 T1110	U	229Y9.7	10,74
256.0013.69 TAMPON REDUCT.PVC 140/100* TAR14100	U	4814C.2	22,82
256.0017.21 TAMPON REDUCT.PVC 160/100* TAR16010	U	4814D.0	28,69
256.0021.77 TAMPON REDUCT.PVC 200/100* TAR20010	U	4814F.5	36,28



TAMPON DE VISITE



DÉSIGNATION	UT	CODE	PPHT (€)
256.0006.19 TAMPON DE VISITE DN. 80 MM TVS80	U	6531Y.6	10,31
256.0008.13 TAMPON DE VISITE PVC EVAC. MF 110 TVS110	U	229XY.8	13,55
256.0040.75 TAMPON DE VISITE D.250* TVSG250	U	5666J.4	67,91

COUDE EVACUATION
FF - 87°30 - A joint

DÉSIGNATION	UT	CODE	PPHT (€)
256.0004.68 COUDE 87.30 JT PVC FF 32 EVAC GIRPI CAI32FF	U	94298.7	7,80

TUBE PVC BLANC
2 Mètres

DÉSIGNATION	UT	CODE	PPHT (€)	ECOPART (€)
267.0026.38 TUBE EVACUATION D032 LG 2M BLC EU2FW	U	5184L.3	32,99	0,02
267.0032.52 TUBE EVACUATION D040 LG 2M BLC EU2HW	U	8640A.7	40,67	0,02

PVC EVACUATION

TUBES ET RACCORDS PVC EVACUATION

COUDE BLANC
MF - 20°

DÉSIGNATION	UT	CODE	PPHT (€)	ECOPART (€)
267.0013.01 COUDE SPLE 20 MF D100 BLC CT2B	U	6613W.1	17,37	0,02

COUDE BLANC
FF - 45°

DÉSIGNATION	UT	CODE	PPHT (€)	ECOPART (€)
267.0001.85 COUDE SPLE 45 FF D032 BLC UCF44B	U	06553.2	2,49	0,02
267.0002.63 COUDE SPLE 45 FF D040 BLC UCH44B	U	06668.8	3,53	0,02

COUDE BLANC
MF - 87°30

DÉSIGNATION	UT	CODE	PPHT (€)	ECOPART (€)
267.0002.91 COUDE SPLE 87.30 MF D032 BLC UCF8B	U	07203.3	2,93	0,02
267.0003.96 COUDE SPLE 87.30 MF D040 BLC UCH8B	U	07234.8	3,98	0,02

COUDE BLANC
FF - 87°30

DÉSIGNATION	UT	CODE	PPHT (€)	ECOPART (€)
267.0002.18 COUDE SPLE 87.30 FF D032 BLC UCF88B	U	06730.6	2,93	0,02
267.0002.97 COUDE SPLE 87.30 FF D040 BLC UCH88B	U	06744.7	3,98	0,02

CULOTTE BLANC
FF - Simple - 45°

DÉSIGNATION	UT	CODE	PPHT (€)	ECOPART (€)
267.0003.98 CULOTTE SPLE 45 FF D032 BLC UBF144B	U	08325.3	5,00	0,02
267.0006.14 CULOTTE SPLE 45 FF D040 BLC UBH144B	U	08381.6	7,70	0,02

PVC EVACUATION

TUBES ET RACCORDS PVC EVACUATION

Nicoll
by aliaxis

CULOTTE BLANC
MF - 45°



	DÉSIGNATION	UT	CODE	PPHT (€)	ECOPART (€)
267.0015.74	CULOTTE SPLE 45 MF D100 BLC BT14B	U	6037Y.5	21,00	0,02

Nicoll
by aliaxis

TE BLANC
FF - Pied de biche - 87°30



	DÉSIGNATION	UT	CODE	PPHT (€)	ECOPART (€)
267.0004.80	TE PIED DE BICHE 87.30 FF D032 BLC UTF188BL	U	07815.4	6,42	0,02
267.0007.75	TE PIED DE BICHE 87.30 FF D040 BLC UTH188BL	U	07923.6	7,77	0,02
267.0016.03	TE PIED DE BICHE 87.30 FF D050 BLC UTJ188BL	U	08008.5	16,05	0,02

Nicoll
by aliaxis

MANCHON BLANC
FF



	DÉSIGNATION	UT	CODE	PPHT (€)	ECOPART (€)
267.0001.00	MANCHON A BUTEE FF D032 BLC UM2FB	U	08133.1	1,36	0,02
267.0001.10	MANCHON A BUTEE FF D040 BLC UM2HB	U	08214.9	1,48	0,02

Nicoll
by aliaxis

TAMPON BLANC
De visite - MF - Avec bouchon



	DÉSIGNATION	UT	CODE	PPHT (€)	ECOPART (€)
267.0001.84	TAMPON DE VISITE AV. BOUCHON MF D032 BLC UFFB	U	08016.8	2,47	0,02
267.0002.41	TAMPON DE VISITE AV. BOUCHON MF D040 BLC UFHB	U	08052.3	2,43	0,02

Nicoll
by aliaxis

REDUCTION BLANC
MF - Incorporée



	DÉSIGNATION	UT	CODE	PPHT (€)	ECOPART (€)
267.0001.82	REDUCTION INCORPOREE MF D040/D032 BLC UIHB	U	07400.5	2,45	0,02

Le PPHT comprend l'ecopart (€)

PVC EVACUATION

TUBES ET RACCORDS PVC EVACUATION

Nicoll
by aliaxis

COUDE
FF - 20°



	DÉSIGNATION	UT	CODE	PPHT (€)	ECOPART (€)
268.0001.52	COUDE SPLE 20 FF D032 GRIS UCF22	U	90543.0	2,03	
267.0001.95	COUDE SPLE 20 FF D040 GRIS UCH22	U	90549.7	2,60	
267.0003.26	COUDE SPLE 20 FF D050 GRIS UCJ22	U	57843.5	4,35	
268.0011.26	COUDE SPLE 20 FF D100 GRIS UCT22	U	93769.8	15,03	0,01

Nicoll
by aliaxis

COUDE
MF - 20°



	DÉSIGNATION	UT	CODE	PPHT (€)	ECOPART (€)
267.0001.52	COUDE SPLE 20 MF D032 GRIS UCF2	U	90755.0	2,03	
267.0001.95	COUDE SPLE 20 MF D040 GRIS UCH2	U	90832.7	2,60	
267.0003.26	COUDE SPLE 20 MF D050 GRIS UCJ2	U	90843.4	4,35	
268.0009.08	COUDE SPLE 20 MF D100 GRIS UCT2	U	93766.4	12,11	0,01

Nicoll
by aliaxis

COUDE
MF - 30°



	DÉSIGNATION	UT	CODE	PPHT (€)	ECOPART (€)
267.0009.92	COUDE SPLE 30 MF D100 GRIS UCT3	U	58110.8	13,23	0,01

Nicoll
by aliaxis

COUDE
FF - 45°



	DÉSIGNATION	UT	CODE	PPHT (€)	ECOPART (€)
268.0001.10	COUDE SPLE 45 FF D032 GRIS UCF44	U	90550.5	1,46	
268.0001.54	COUDE SPLE 45 FF D040 GRIS UCH44	U	90562.0	2,06	
268.0002.82	COUDE SPLE 45 FF D050 GRIS UCJ44	U	57938.3	3,76	
267.0004.10	COUDE SPLE 45 FF D063 GRIS UCL44	U	90563.8	5,47	
268.0006.52	COUDE SPLE 45 FF D080 GRIS UCR44	U	90564.6	8,70	0,01
268.0008.94	COUDE SPLE 45 FF D100 GRIS UCT44	U	90567.9	11,93	0,01
268.0013.50	COUDE SPLE 45 FF D125 GRIS UCX44	U	90568.7	18,01	0,01

Nicoll
by aliaxis

COUDE
MF - 45°



	DÉSIGNATION	UT	CODE	PPHT (€)	ECOPART (€)
268.0001.10	COUDE SPLE 45 MF D032 GRIS UCF4	U	90874.9	1,46	
268.0001.54	COUDE SPLE 45 MF D040 GRIS UCH4	U	90877.2	2,06	

PVC EVACUATION

TUBES ET RACCORDS PVC EVACUATION

Nicoll
by atlaxis

COUDE
MF - 45°
- suite



	DÉSIGNATION	UT	CODE	PPHT (€)	ECOPART (€)
268.0002.82	COUDE SPLE 45 MF D050 GRIS UCJ4	U	90895.4	3,76	
267.0003.94	COUDE SPLE 45 MF D063 GRIS UCL4	U	90919.2	5,25	
268.0004.38	COUDE SPLE 45 MF D080 GRIS UCR4	U	90953.1	5,85	0,01
268.0007.44	COUDE SPLE 45 MF D100 GRIS UCT4	U	90954.9	9,93	0,01
268.0010.84	COUDE SPLE 45 MF D110 GRIS UCV4	U	57911.0	14,47	0,01
268.0012.49	COUDE SPLE 45 MF D125 GRIS UCX4	U	90971.3	16,66	0,01

Nicoll
by atlaxis

COUDE
FF - 67°30



	DÉSIGNATION	UT	CODE	PPHT (€)	ECOPART (€)
267.0001.41	COUDE SPLE 67.30 FF D032 GRIS UCF66	U	90569.5	1,88	
267.0002.02	COUDE SPLE 67.30 FF D040 GRIS UCH66	U	90570.3	2,70	
267.0003.46	COUDE SPLE 67.30 FF D050 GRIS UCJ66	U	57979.7	4,62	
267.0004.10	COUDE SPLE 67.30 FF D063 GRIS UCL66	U	90572.9	5,47	
268.0009.92	COUDE SPLE 67.30 FF D100 GRIS UCT66	U	90591.9	13,23	0,01

Nicoll
by atlaxis

COUDE
MF - 67°30



	DÉSIGNATION	UT	CODE	PPHT (€)	ECOPART (€)
267.0001.41	COUDE SPLE 67.30 MF D032 GRIS UCF6	U	90974.7	1,88	
267.0002.02	COUDE SPLE 67.30 MF D040 GRIS UCH6	U	90977.0	2,70	
267.0005.74	COUDE SPLE 67.30 MF D080 GRIS UCR6	U	7811B.0	7,66	0,01
268.0008.03	COUDE SPLE 67.30 MF D100 GRIS UCT6	U	91001.8	10,72	0,01

Nicoll
by atlaxis

COUDE
FF - 87°30



	DÉSIGNATION	UT	CODE	PPHT (€)	ECOPART (€)
268.0001.27	COUDE SPLE 87.30 FF D032 GRIS UCF88	U	90597.6	1,69	
268.0001.73	COUDE SPLE 87.30 FF D040 GRIS UCH88	U	90599.2	2,31	
268.0003.36	COUDE SPLE 87.30 FF D050 GRIS UCJ88	U	93790.4	4,48	
267.0004.13	COUDE SPLE 87.30 FF D063 GRIS UCL88	U	90603.2	5,52	0,01
268.0006.57	COUDE SPLE 87.30 FF D080 GRIS UCR88	U	90604.0	8,77	0,01
268.0009.41	COUDE SPLE 87.30 FF D100 GRIS UCT88	U	90607.3	12,56	0,01
268.0014.54	COUDE SPLE 87.30 FF D125 GRIS UCX88	U	90608.1	19,40	0,01

PVC EVACUATION

TUBES ET RACCORDS PVC EVACUATION

Nicoll
by atlaxis

COUDE
MF - 87°30



	DÉSIGNATION	UT	CODE	PPHT (€)	ECOPART (€)
268.0001.28	COUDE SPLE 87.30 MF D032 GRIS UCF8	U	91004.2	1,70	
268.0001.73	COUDE SPLE 87.30 MF D040 GRIS UCH8	U	91005.9	2,31	
268.0003.36	COUDE SPLE 87.30 MF D050 GRIS UCJ8	U	91006.7	4,48	
267.0003.69	COUDE SPLE 87.30 MF D063 GRIS UCL8	U	91007.5	4,92	
268.0005.54	COUDE SPLE 87.30 MF D080 GRIS UCR8	U	91009.1	7,40	0,01
268.0008.52	COUDE SPLE 87.30 MF D100 GRIS UCT8	U	91010.9	11,37	0,01
268.0011.53	COUDE SPLE 87.30 MF D125 GRIS UCX8	U	91011.7	15,38	0,01

Nicoll
by atlaxis

COUDE
FF - 87°30 - Double - Parallèle



	DÉSIGNATION	UT	CODE	PPHT (€)	ECOPART (€)
267.0008.25	COUDE DBL.PARAL.87.30 FF D032 GRD RAYON UOF88	U	10846.4	11,00	
267.0009.64	COUDE DBL.PARAL.87.30 FF D040 GRD RAYON UOH88	U	58061.3	12,86	

Nicoll
by atlaxis

COUDE
MF - 87°30 - Double - Parallèle



	DÉSIGNATION	UT	CODE	PPHT (€)	ECOPART (€)
267.0008.24	COUDE DBL.PARAL.87.30 MF D032 GRD RAYON UOF8	U	56329.6	10,99	
267.0009.64	COUDE DBL.PARAL.87.30 MF D040 GRD RAYON UOH8	U	0057B.8	12,86	
267.0017.56	COUDE DBL.PARAL.87.30 MF D050 GRD RAYON UOJ8	U	56451.8	17,56	
267.0033.04	COUDE DBL.PARAL.87.30 MF D100 GRIS UOT8	U	8823A.6	44,07	0,01

Nicoll
by atlaxis

COUDE
MF - 87°30 - Double - D'équerre



	DÉSIGNATION	UT	CODE	PPHT (€)	ECOPART (€)
267.0035.14	COUDE DBL.EQUERRE 87.30 MF D100 GRIS UCET8	U	10859.7	46,87	0,01

Nicoll
by atlaxis

COUDE
Secteur de coude - MF - 15°



	DÉSIGNATION	UT	CODE	PPHT (€)	ECOPART (€)
267.0004.01	SECTEUR DE COUDE 15 MF D100 GRIS UST1	U	68922.4	5,35	
267.0010.67	SECTEUR DE COUDE 15 MF D200 GRIS SB1	U	68926.5	14,24	0,01

Le PPHT comprend l'ecopart (€)

PVC EVACUATION

TUBES ET RACCORDS PVC EVACUATION

Nicoll
by allaxis

COUDE

Secteur de coude - MF - 30°



	DÉSIGNATION	UT	CODE	PPHT (€)
267.0004.23	SECTEUR DE COUDE 30 MF D100 GRIS UST3	U	68920.8	5,64

Nicoll
by allaxis

TE

FFF - Pied de biche - 87°30



	DÉSIGNATION	UT	CODE	PPHT (€)
268.0003.77	TE PIED DE BICHE 87.30 FF D032 GRIS UTF188	U	93776.3	3,77
268.0003.38	TE PIED DE BICHE 87.30 FF D040 GRIS UTH188	U	91084.4	4,50
267.0003.49	TE PIED DE BICHE 87.30 FF D040/32 GRIS UTH288	U	58142.1	4,65
268.0007.09	TE PIED DE BICHE 87.30 FF D050 GRIS UTJ188	U	58153.8	9,45
267.0005.81	TE PIED DE BICHE 87.30 FF D050/32 GRIS UTJ388	U	58183.5	7,75
267.0006.58	TE PIED DE BICHE 87.30 FF D050/40 GRIS UTJ288	U	58159.5	8,78

Nicoll
by allaxis

TE

MFF - Pied de biche - 87°30



	DÉSIGNATION	UT	CODE	PPHT (€)
267.0007.09	TE PIED DE BICHE 87.30 MF D050 GRIS UTJ18	U	58118.1	9,45

Nicoll
by allaxis

TE

MFF - Pied de biche - 87°30 - Grand rayon



	DÉSIGNATION	UT	CODE	PPHT (€)
267.0002.83	TE PIED DE BICHE 87.30 GRD RAY.MF D32 UTF18	U	91087.7	3,77
267.0004.25	TE PIED DE BICHE 87.30 GRD RAY.MF D40 UTH18	U	58114.0	5,67

Nicoll
by allaxis

CULOTTE / EMBRANCHEMENT

FFF - 45° - Simple



	DÉSIGNATION	UT	CODE	PPHT (€)	ECOPART (€)
267.0002.17	CULOTTE SPLE 45 FF D032 GRIS UBF144	U	90148.8	2,89	
267.0003.49	CULOTTE SPLE 45 FF D040 GRIS UBH144	U	90170.2	4,65	
268.0004.91	CULOTTE SPLE 45 FF D050 GRIS UBJ144	U	90176.9	6,55	
267.0008.70	CULOTTE SPLE 45 FF D063 GRIS UBL144	U	90178.5	11,61	0,01
268.0010.78	CULOTTE SPLE 45 FF D080 GRIS UBR144	U	90185.0	14,39	0,01
268.0012.88	CULOTTE SPLE 45 FF D100 GRIS UBT144	U	57813.8	17,19	0,01
268.0021.70	CULOTTE SPLE 45 FF D125 GRIS UBX144	U	90187.6	28,96	0,02

Le PPHT comprend l'ecopart (€)

PVC EVACUATION

TUBES ET RACCORDS PVC EVACUATION

Nicoll
by allaxis

CULOTTE / EMBRANCHEMENT

MF - 45° - Simple



	DÉSIGNATION	UT	CODE	PPHT (€)	ECOPART (€)
267.0002.17	CULOTTE SPLE 45 MF D032 GRIS UBF14	U	90266.8	2,89	
267.0003.49	CULOTTE SPLE 45 MF D040 GRIS UBH14	U	90274.2	4,65	
267.0004.91	CULOTTE SPLE 45 MF D050 GRIS UBJ14	U	90281.7	6,55	
268.0009.01	CULOTTE SPLE 45 MF D080 GRIS UBR14	U	90312.0	12,02	0,01
268.0010.73	CULOTTE SPLE 45 MF D100 GRIS UBT14	U	90330.2	14,32	0,01
268.0018.09	CULOTTE SPLE 45 MF D125 GRIS UBX14	U	90331.0	24,14	0,02

Nicoll
by allaxis

CULOTTE / EMBRANCHEMENT

MF - 45° - Simple



	DÉSIGNATION	UT	CODE	PPHT (€)	ECOPART (€)
267.0011.49	EMBRANCHEMENT SIMPLE 45 MF D100/040 UBT74	U	57556.3	15,33	0,01
267.0011.55	EMBRANCHEMENT SIMPLE 45 MF D100/050 UBT64	U	57535.7	15,41	0,01
267.0019.09	EMBRANCHEMENT SIMPLE 45 MF D125/100 UBX34	U	12851.2	25,47	0,02
267.0042.92	EMBRANCHEMENT SIMPLE 45 MF D160/100 UBZ54	U	2693C.2	57,24	0,02
267.0047.49	EMBRANCHEMENT SIMPLE 45 MF D160/125 UBZ34	U	2690C.5	63,35	0,03
267.0069.14	EMBRANCHEMENT SIMPLE 45 MF D200/100 UBB64	U	51832.4	92,21	0,03
267.0071.91	EMBRANCHEMENT SIMPLE 45 MF D200/125 UBB44	U	2702C.1	95,91	0,03

Nicoll
by allaxis

CULOTTE / EMBRANCHEMENT

FF - 87°30 - Simple



	DÉSIGNATION	UT	CODE	PPHT (€)	ECOPART (€)
267.0002.17	CULOTTE SPLE 87.30 FF D032 GRIS UBF188	U	90251.0	2,89	
267.0003.49	CULOTTE SPLE 87.30 FF D040 GRIS UBH188	U	90254.4	4,65	
268.0004.91	CULOTTE SPLE 87.30 FF D050 GRIS UBJ188	U	90259.3	6,55	
267.0008.70	CULOTTE SPLE 87.30 FF D063 GRIS UBL188	U	90260.1	11,61	0,01
268.0010.78	CULOTTE SPLE 87.30 FF D080 GRIS UBR188	U	90264.3	14,39	0,01
268.0012.88	CULOTTE SPLE 87.30 FF D100 GRIS UBT188	U	58128.0	17,19	0,01
268.0021.70	CULOTTE SPLE 87.30 FF D125 GRIS UBX188	U	90265.0	28,96	0,02

Nicoll
by allaxis

CULOTTE / EMBRANCHEMENT

MF - 87°30 - Simple



	DÉSIGNATION	UT	CODE	PPHT (€)	ECOPART (€)
267.0002.17	CULOTTE SPLE 87.30 MF D032 GRIS BF18	U	90426.8	2,89	
267.0003.49	CULOTTE SPLE 87.30 MF D040 GRIS UBH18	U	90429.2	4,65	
267.0004.91	CULOTTE SPLE 87.30 MF D050 GRIS UBJ18	U	90433.4	6,55	
267.0008.56	CULOTTE SPLE 87.30 MF D063 GRIS UBL18	U	90454.0	11,43	0,01
268.0009.86	CULOTTE SPLE 87.30 MF D080 GRIS UBR18	U	90459.9	13,16	0,01
268.0010.73	CULOTTE SPLE 87.30 MF D100 GRIS UBT18	U	90460.7	14,32	0,01
268.0018.09	CULOTTE SPLE 87.30 MF D125 GRIS UBX18	U	90509.1	24,14	0,02

PVC EVACUATION

TUBES ET RACCORDS PVC EVACUATION

Nicoll
by aliaxis

CULOTTE / EMBRANCHEMENT
MF - 87°30 - Simple



	DÉSIGNATION	UT	CODE	PPHT (€)	ECOPART (€)
267.0011.49	EMBRANCHEMENT SIMPLE 87.30 MF D100/40 UBT78	U	58001.9	15,33	0,01
267.0011.55	EMBRANCHEMENT SIMPLE 87.30 MF D100/50 UBT68	U	57994.6	15,41	0,01

Nicoll
by aliaxis

CULOTTE / EMBRANCHEMENT
FF - 45° - Double - Parallèle



	DÉSIGNATION	UT	CODE	PPHT (€)	ECOPART (€)
267.0005.54	CULOTTE DBL.PAR.45 FF D040 GRIS RH144	U	8847A.8	7,39	

Nicoll
by aliaxis

CULOTTE / EMBRANCHEMENT
MF - 45° - Double - Parallèle



	DÉSIGNATION	UT	CODE	PPHT (€)	ECOPART (€)
267.0022.22	CULOTTE DBL.PAR.45 MF D100 GRIS URT14	U	57689.2	29,64	0,02
267.0040.30	CULOTTE DBL.PAR.45 MF D125 GRIS RX14	U	9593N.6	53,75	0,02

Nicoll
by aliaxis

CULOTTE / EMBRANCHEMENT
MF - 45° - Double - D'équerre



	DÉSIGNATION	UT	CODE	PPHT (€)	ECOPART (€)
267.0030.45	CULOTTE DBL.EQUERRE 45 MF D100 GRIS UAT14	U	93775.5	40,61	0,01

Nicoll
by aliaxis

CULOTTE / EMBRANCHEMENT
MF - 87°30 - Double - Parallèle



	DÉSIGNATION	UT	CODE	PPHT (€)	ECOPART (€)
267.0022.22	CULOTTE DBL.PAR.87.30 MF D100 GRIS URT18	U	58062.1	29,63	0,01

Nicoll
by aliaxis

CULOTTE / EMBRANCHEMENT
MF - 87°30 - Double - D'équerre



	DÉSIGNATION	UT	CODE	PPHT (€)	ECOPART (€)
267.0030.45	CULOTTE DBL.EQUERRE 87.30 MF D100 GRIS UAT18	U	93773.0	40,61	0,01

PVC EVACUATION

TUBES ET RACCORDS PVC EVACUATION

Nicoll
by aliaxis

DOUILLE
FF - Ecrou prisonnier



	DÉSIGNATION	UT	CODE	PPHT (€)	ECOPART (€)
267.0004.21	DOUILLE FEM.A ECROU PRIS.D032-33X42 UDEFF	U	08480.6	5,61	
267.0004.51	DOUILLE FEM.A ECROU PRIS.D040-40X49 UDEHH	U	08482.2	6,01	
267.0004.51	DOUILLE FEM.A ECROU PRIS.D050-40X49 UDEJJ	U	61681.3	6,01	

Nicoll
by aliaxis

MANCHON
MF - De dilatation - Position horizontale



	DÉSIGNATION	UT	CODE	PPHT (€)	ECOPART (€)
267.0012.14	MANCHON DILAT.CANAL.HORIZ.MF D032 GRIS UMFH	U	52373.8	16,18	
267.0012.54	MANCHON DILAT.CANAL.HORIZ.MF D040 GRIS UMHH	U	52399.3	16,72	
267.0013.03	MANCHON DILAT.CANAL.HORIZ.MF D050 GRIS UMJH	U	52408.2	17,38	0,01
267.0015.72	MANCHON DILAT.CANAL.HORIZ.MF D063 GRIS UMLH	U	52415.7	20,97	0,01
267.0017.72	MANCHON DILAT.CANAL.HORIZ.MF D080 GRIS UMRH	U	52432.2	23,63	0,01
268.0019.02	MANCHON DILAT.CANAL.HORIZ.MF D100 GRIS UMTH	U	52437.1	25,37	0,01
267.0023.97	MANCHON DILAT.CANAL.HORIZ.MF D125 GRIS UMXH	U	52463.7	31,97	0,01

Nicoll
by aliaxis

MANCHON
FF - De dilatation



	DÉSIGNATION	UT	CODE	PPHT (€)	ECOPART (€)
267.0089.51	MANCHON DILATA JOINT EN GORGE FF D250 UM2D6	U	8995D.2	119,37	0,02

Nicoll
by aliaxis

MANCHON
FF



	DÉSIGNATION	UT	CODE	PPHT (€)	ECOPART (€)
268.0000.60	MANCHON A BUTEE FF D032 GRIS UMZF	U	91092.7	0,80	
268.0000.71	MANCHON A BUTEE FF D040 GRIS UMZH	U	91093.5	0,95	
268.0001.28	MANCHON A BUTEE FF D050 GRIS UMZJ	U	91096.8	1,71	
267.0002.44	MANCHON A BUTEE FF D063 GRIS UMZL	U	91099.2	3,25	
268.0002.87	MANCHON A BUTEE FF D080 GRIS UMZR	U	91107.3	3,83	
268.0003.61	MANCHON A BUTEE FF D100 GRIS UMZT	U	91111.5	4,82	0,01
268.0005.42	MANCHON A BUTEE FF D125 GRIS UMZX	U	91113.1	7,24	0,01

Le PPHT comprend l'ecopart (€)

PVC EVACUATION

TUBES ET RACCORDS PVC EVACUATION

Nicoll
by aliaxis

MANCHETTE

FF - D'adaptation - A visser sur bouchon



	DÉSIGNATION	UT	CODE	PPHT (€)	
267.0001.56	MANCHETTE ADAPT.A VISS.FEMELLE D032 UMFA3	U	58088.6	2,08	
267.0001.69	MANCHETTE ADAPT.A VISS.FEMELLE D040 UMFA4	U	93778.9	2,25	

Nicoll
by aliaxis

MANCHETTE

MF - De réparation



	DÉSIGNATION	UT	CODE	PPHT (€)	ECOPART (€)
267.0001.16	MANCHETTE REPARATION MALE D032 ZFF	U	4759A.3	1,55	
268.0006.23	MANCHETTE REPARATION MALE D100 UZTT	U	35526.3	8,32	0,01
267.0008.38	MANCHETTE REPARATION MALE D125 UZXX	U	09062.1	11,19	0,01
267.0001.52	MANCHETTE REPARATION MALE D040 UZHH	U	4581A.7	2,02	
267.0001.82	MANCHETTE REPARATION MALE D050 UZJJ	U	4762A.8	2,42	

Nicoll
by aliaxis

MANCHETTE

FF - De réparation



	DÉSIGNATION	UT	CODE	PPHT (€)	ECOPART (€)
267.0031.42	MANCHETTE REPARATION FEMELLE D100 UMTH227	U	45149.2	41,91	0,01
267.0039.62	MANCHETTE REPARATION FEMELLE D125 UMXH258	U	64465.8	52,84	0,02

Nicoll
by aliaxis

MANCHETTE

MF - Souple



	DÉSIGNATION	UT	CODE	PPHT (€)	ECOPART (€)
267.0006.58	MANCHETTE RENOVATION SOUPLE MF D032 FLEXFM	U	7584A.7	8,79	0,02
267.0007.87	MANCHETTE RENOVATION SOUPLE MF D040 FLEXHM	U	7581A.0	10,51	0,02

Nicoll
by aliaxis

MANCHETTE

FF - Souple



	DÉSIGNATION	UT	CODE	PPHT (€)	ECOPART (€)
267.0006.58	MANCHETTE RENOVATION SOUPLE FF D032 FLEXF	U	60145.0	8,79	0,02
267.0007.87	MANCHETTE RENOVATION SOUPLE FF D040 FLEXH	U	60156.7	10,51	0,02
267.0010.05	MANCHETTE RENOVATION SOUPLE FF D050 FLEXJ	U	60161.7	13,42	0,02

Le PPHT comprend l'ecopart (€)

PVC EVACUATION

TUBES ET RACCORDS PVC EVACUATION

Nicoll
by aliaxis

REDUCTION

MF - Incorporée - Mâle-Femelle



	DÉSIGNATION	UT	CODE	PPHT (€)	
268.0001.07	REDUCTION INCORPOREE MF D040/032 GRIS UIH	U	91071.1	1,43	
267.0001.34	REDUCTION INCORPOREE MF D050/032 GRIS UIJF	U	91080.2	1,79	
268.0001.28	REDUCTION INCORPOREE MF D050/040 GRIS UIJ	U	91083.6	1,71	

Nicoll
by aliaxis

REDUCTION

MF - Extérieure excentrée



	DÉSIGNATION	UT	CODE	PPHT (€)	ECOPART (€)
267.0005.70	REDUCTION EXCENTREE MF D100/080 UIT2	U	78275.5	7,61	0,01
267.0008.13	REDUCTION EXCENTREE MF D125/100 UIX2	U	93760.7	10,85	0,01
267.0119.80	REDUCTION EXCENTREE MF D250/100 ID7	U	5572E.6	159,76	0,02
267.0119.80	REDUCTION EXCENTREE MF D250/125 ID5	U	32064.8	159,76	0,02
267.0119.80	REDUCTION EXCENTREE MF D250/160 ID3	U	32063.0	159,76	0,02
267.0128.46	REDUCTION EXCENTREE MF D315/160 IE4	U	5572H.0	171,33	0,05

Nicoll
by aliaxis

TAMPON

De raccordement - MF - En élastomère - Métal plastique



	DÉSIGNATION	UT	CODE	PPHT (€)	
267.0003.62	REDUCTION METAL PLASTIQUE MF D032 URMPF	U	65210.7	4,82	
267.0003.62	REDUCTION METAL PLASTIQUE MF D040 URMPH	U	06592.0	4,82	
267.0003.70	REDUCTION METAL PLASTIQUE MF D050 URMPJ	U	31092.0	4,93	

Nicoll
by aliaxis

TAMPON

De raccordement - MF - En élastomère - A capeler



	DÉSIGNATION	UT	CODE	PPHT (€)	
267.0014.30	TAMPON ELAST.CAPELER MF.100/50/40/32 UTNT543	U	005N0.3	19,07	

Nicoll
by aliaxis

TAMPON

MF - Réduction - Simple

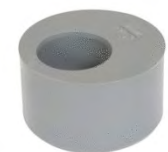

	DÉSIGNATION	UT	CODE	PPHT (€)	ECOPART (€)
267.0004.63	TAMPON REDUCT.SPL.MF D063/032 UL3	U	90020.9	6,17	
267.0004.63	TAMPON REDUCT.SPL.MF D063/040 UL4	U	90071.2	6,17	
267.0004.63	TAMPON REDUCT.SPL.MF D063/050 UL5	U	90072.0	6,17	

PVC EVACUATION

TUBES ET RACCORDS PVC EVACUATION

Nicoll
by aliaxis

TAMPON

MF - Réduction - Simple
- suite



	DÉSIGNATION	UT	CODE	PPHT (€)	ECOPART (€)
267.0005.86	TAMPON REDUCT.SPL.MF D080/040 UR4	U	7815B.6	7,81	
267.0005.86	TAMPON REDUCT.SPL.MF D080/050 UR5	U	18049.7	7,81	
267.0005.86	TAMPON REDUCT.SPL.MF D080/063 UR6	U	57670.2	7,81	
267.0006.18	TAMPON REDUCT.SPL.MF D100/032 UT3	U	90083.7	8,24	
268.0005.96	TAMPON REDUCT.SPL.MF D100/040 UT4	U	57702.3	7,95	
268.0005.82	TAMPON REDUCT.SPL.MF D100/050 UT5	U	90088.6	7,76	
267.0006.18	TAMPON REDUCT.SPL.MF D100/080 UT8	U	90129.8	8,24	
267.0007.58	TAMPON REDUCT.SPL.MF D110/100 UV10	U	57707.2	10,12	0,01
267.0008.04	TAMPON REDUCT.SPL.MF D125/050 X5	U	6722H.7	10,73	0,01
267.0007.60	TAMPON REDUCT.SPL.MF D125/100 UX10	U	90130.6	10,15	0,01
267.0007.60	TAMPON REDUCT.SPL.MF D125/110 UX11	U	57728.8	10,15	0,01

Nicoll
by aliaxis

TAMPON

MF - Double



	DÉSIGNATION	UT	CODE	PPHT (€)
267.0005.82	TAMPON REDUCT.DBL.MF D100/40/40 GRIS UT44	U	90140.5	7,76
267.0006.18	TAMPON REDUCT.DBL.MF D100/50/40 GRIS UT54	U	78454.6	8,24

Nicoll
by aliaxis

TAMPON

De réduction - Mâle - Sur tube non
prémanchonné ø100



	DÉSIGNATION	UT	CODE	PPHT (€)
268.0005.82	TAMPON REDUCT.P.TUBE MF D093/040 GRIS UTT4	U	68502.4	7,76
268.0005.82	TAMPON REDUCT.P.TUBE MF D093.6/40/40 UTT44	U	58081.1	7,76
267.0005.82	TAMPON REDUCT.P.TUBE MF D093/050 GRIS UTT5	U	58847.5	7,76

Nicoll
by aliaxis

TAMPON

De visite - MF - Avec bouchon



	DÉSIGNATION	UT	CODE	PPHT (€)	ECOPART (€)
268.0001.18	TAMPON DE VISITE AV.BOUCHON MF D032 GRIS UFF	U	91015.8	1,58	
268.0001.24	TAMPON DE VISITE AV.BOUCHON MF D040 GRIS UFH	U	91016.6	1,65	
268.0001.82	TAMPON DE VISITE AV.BOUCHON MF D050 GRIS UFJ	U	91018.2	2,42	
267.0007.00	TAMPON DE VISITE AV.BOUCHON MF D063 GRIS UFL	U	91019.0	9,33	
267.0007.90	TAMPON DE VISITE AV.BOUCHON MF D080 GRIS UFR	U	91033.1	10,53	
268.0007.38	TAMPON DE VISITE AV.BOUCHON MF D100 GRIS UFT	U	91042.2	9,84	
268.0010.34	TAMPON DE VISITE AV.BOUCHON MF D125 GRIS UFX	U	91058.8	13,79	0,01

PVC EVACUATION

TUBES ET RACCORDS PVC EVACUATION

Nicoll
by aliaxis

TAMPON

MF - De réduction - Excentré



	DÉSIGNATION	UT	CODE	PPHT (€)	ECOPART (€)
267.0115.10	TAMPON EVAC.EXCENTRE MF 140X125 YXF	U	72581.5	153,47	0,01
267.0096.94	TAMPON REDUCT.EXCENTRE MF 200X140 BYF	U	7255T.9	129,27	0,01

Nicoll
by aliaxis

TAMPON

MF - De réduction



	DÉSIGNATION	UT	CODE	PPHT (€)	ECOPART (€)
267.0020.85	REDUCTION INCORPOREES 118-100 XX10	U	8320R.2	27,81	0,01

Nicoll
by aliaxis

TAMPON

MF - Excentré



	DÉSIGNATION	UT	CODE	PPHT (€)
250.0090.96	TAMPON EVAC.FACONNE MF 160/140 Z14	U	203AM.3	121,28
267.0166.60	TAMPON EVAC.FACONNE MF 250/100 D10	U	203AN.1	222,13
267.0125.53	TAMPON EVAC.FACONNE MF 250/125 D12	U	203AP.9	167,37
267.0121.41	TAMPON EVAC.FACONNE MF 250/140 D14	U	203AQ.7	161,88
267.0127.69	TAMPON EVAC.FACONNE MF 250/160 D16	U	203AR.5	170,25
267.0135.70	TAMPON EVAC.FACONNE MF 250/200 D20CON	U	203AS.3	180,93
267.0176.94	TAMPON EVAC.FACONNE MF 315/160 E16	U	203AT.1	235,92
267.0194.26	TAMPON EVAC.FACONNE MF 315/200 E20	U	203AU.8	259,02

Nicoll
by aliaxis

SELLE

MF - 90° - Extension du réseau



	DÉSIGNATION	UT	CODE	PPHT (€)
267.0003.70	SELLE BRANCHEMENT MF 90 D080/075/040 USL874	U	22857.7	4,94
267.0004.14	SELLE BRANCHEMENT MF 90 D100/032 GRIS USL103	U	70099.7	5,52
267.0004.36	SELLE BRANCHEMENT MF 90 D100/040 GRIS USL104	U	67433.3	5,82
267.0004.42	SELLE BRANCHEMENT MF 90 D100/050 GRIS USL105	U	67434.1	5,90
267.0005.54	SELLE BRANCHEMENT MF 90 D125/050 GRIS USL125	U	58111.6	7,39

Nicoll
by aliaxis

COUDE SYSTEME J

FF - 87°30 - Pour sortie d'appareils sanitaires



	DÉSIGNATION	UT	CODE	PPHT (€)	ECOPART (€)
267.0005.89	COUDE SPLE 87.30 A JOINT FF D032 GRIS UCF88J	U	93784.7	7,85	

Le PPHT comprend l'ecopart (€)

PVC EVACUATION

TUBES ET RACCORDS PVC EVACUATION

Nicoll
by aliaxis

COUDE SYSTEME J

FF - 87°30 - Pour sortie d'appareils sanitaires
- suite



	DÉSIGNATION	UT	CODE	PPHT (€)	ECOPART (€)
267.0006.23	COUDE SPLE 87.30 A JOINT FF D040 GRIS UCH88J	U	93785.4	8,31	
267.0010.68	COUDE SPLE 87.30 A JOINT FF D050 GRIS CJ88J	U	93787.0	14,25	0,01

Nicoll
by aliaxis

MANCHETTE SYSTEME J

FF - A joint



	DÉSIGNATION	UT	CODE	PPHT (€)	ECOPART (€)
267.0005.49	MANCHETTE A JOINT SYSTEME-J FF D032 MAF2J	U	73044.0	7,85	
267.0005.82	MANCHETTE A JOINT SYSTEME-J FF D040 UMAH2J	U	73046.5	8,31	

Nicoll
by aliaxis

COLLIER PVC

Monobloc



	DÉSIGNATION	UT	CODE	PPHT (€)	ECOPART (€)
267.0001.06	COLLIER MONOBLOC INS.P.7/150 D032 GRIS CM32	U	38161.6	1,43	0,02
267.0001.16	COLLIER MONOBLOC INS.P.7/150 D040 GRIS CM40	U	38162.4	1,57	0,02
267.0001.40	COLLIER MONOBLOC INS.P.7/150 D050 GRIS CM50	U	38163.2	1,89	0,02

Nicoll
by aliaxis

COLLIER PVC

Monobloc - blanc



	DÉSIGNATION	UT	CODE	PPHT (€)	ECOPART (€)
267.0001.34	COLLIER MONOBLOC INS.P.7/150 D032 BLC CM32BL	U	07537.4	1,80	0,02
267.0001.46	COLLIER MONOBLOC INS.P.7/150 D040 BLC CM40BL	U	07555.6	1,97	0,02

WAVIN
An Orbia business.

MANCHON

MF - De dilatation - Position horizontale et
verticale



	DÉSIGNATION	UT	CODE	PPHT (€)	ECOPART (€)
256.0015.71	MANCHON DILAT.MF 63 EVAC. PVC WAVIN 3025555	U	02536.1	15,72	0,01

Le PPHT comprend l'ecopart (€)

PVC EVACUATION

TUBES ET RACCORDS PVC EVACUATION ACOUSTIQUE

Nicoll
by aliaxis

TUBE PVC CHUTUNIC®

Hélicoïdaux acoustiques - ø 100 mm



	DÉSIGNATION	UT	CODE	PPHT (€)	ECOPART (€)
239.0066.46	TUBE HELICOÏDAL ACOUSTIQ.D100 LG 2M60 THA260	U	4312A.3	88,72	0,10

RACCORDS PVC SANITAIRE

CETA
LA SOLUTION

PIPE SOUPLE DE WC

Extensible



	DÉSIGNATION	UT	CODE	PPHT (€)	ECOPART (€)
525.0036.20	PIPE SOUPLE D100/110MM 320A670 214-MULTIBATI	U	2470C.1	55,71	0,01
525.0038.27	PIPE SOUPLE 100/110MM 280A650 214-MULTIFORME	U	86680.6	47,85	0,01
525.0024.24	PIPE WC COUDEE EXTENS.D93/100 214-MULTIPIPE	U	49131.6	32,33	0,01

Nicoll
by aliaxis

SIPHON DE MACHINE A LAVER EN PVC C

Simple - À sortie horizontale



	DÉSIGNATION	UT	CODE	PPHT (€)	ECOPART (€)
267.0021.20	SIPHON M.A.L SPLE SORT.HORIZ.D40 BLC 1YH42CB	U	9772L.3	28,28	0,02
268.0012.92	SIPHON M.A.L SPLE SORT.HORIZ.D40 GRIS 1YH42C	U	95758.9	17,24	0,02

Nicoll
by aliaxis

SIPHON DE MACHINE A LAVER EN PVC C

Simple - A sortie horizontale orientable



	DÉSIGNATION	UT	CODE	PPHT (€)	ECOPART (€)
267.0016.27	SIPHON M.A.L SPLE SORT.HORIZ.D40 GRIS 1YH22C	U	50665.9	21,71	0,02

Nicoll
by aliaxis

SIPHON DE MACHINE A LAVER EN PVC C

Double - A sortie horizontale orientable



	DÉSIGNATION	UT	CODE	PPHT (€)	ECOPART (€)
267.0043.36	SIPHON M.A.L DBLE SORT.HORIE.D40 GRIS 1YH26C	U	66976.2	57,84	0,02

PVC EVACUATION

RACCORDS PVC SANITAIRE

Nicoll
by aliaxis

SIPHON DE MACHINE A LAVER EN PVC C
Simple - A sortie verticale orientable



	DÉSIGNATION	UT	CODE	PPHT (€)	ECOPART (€)
268.0030.78	SIPHON M.A.L SPLE ORIENT.SORT.VERT.D40 1YH23C	U	50664.2	41,06	0,02

Nicoll
by aliaxis

SIPHON DE LAVABO EN PVC C
Siphon à coller - Entrée horizontale



	DÉSIGNATION	UT	CODE	PPHT (€)	ECOPART (€)
267.0032.02	SIPHON LAVA COLL.ENTREE HORIZ.D50 GRIS YJ1C	U	54751.3	42,72	0,02

Nicoll
by aliaxis

TRAPPE DE VISITE
Carrée



	DÉSIGNATION	UT	CODE	PPHT (€)	ECOPART (€)
757.0036.44	TRAPPE DE VISITE 24X24 BLC 1TV24	U	57281.1	48,60	0,01

Nicoll
by aliaxis

ACCESSOIRES SANITAIRE
Anti-vidé en té



	DÉSIGNATION	UT	CODE	PPHT (€)	ECOPART (€)
267.0024.40	TE AV.PRISE ANTI-VIDE D40 ATVH	U	13295.1	32,55	0,02

Nicoll
by aliaxis

ACCESSOIRES SANITAIRE
Clapet anti-retour PVC pour évacuation des eaux usées



	DÉSIGNATION	UT	CODE	PPHT (€)	ECOPART (€)
267.0034.85	CLAPET ANTI-RETOUR SANITAIRE 45 D032 CASF4	U	4282A.9	46,49	0,02
267.0047.06	CLAPET ANTI-RETOUR SANITAIRE 45 D040 CASH4	U	4285A.6	62,76	0,02
267.0062.48	CLAPET ANTI-RETOUR SANITAIRE 45 D050 CASJ4	U	4288A.3	83,33	0,02

Nicoll
by aliaxis

PIPE POUR WC EN PVC
Courte à coller



	DÉSIGNATION	UT	CODE	PPHT (€)	ECOPART (€)
267.0023.19	PIPE COURTE D040 JT NEOPRENE 90/100 CWP40	U	43269.0	29,01	0,02

PVC EVACUATION

RACCORDS PVC SANITAIRE

Nicoll
by aliaxis

PIPE POUR WC EN PVC
Courte à coller - Orientable



	DÉSIGNATION	UT	CODE	PPHT (€)	ECOPART (€)
267.0025.39	PIPE ORIENTABLE A JT D100 1PWOR	U	52141.9	31,76	0,02
526.0028.73	PIPE ORIENT.D100 JT 85/107 RECOUPABLE PORTWC	U	251AR.4	35,93	0,02

Nicoll
by aliaxis

PIPE POUR WC EN PVC
Courte à coller - Sortie verticale



	DÉSIGNATION	UT	CODE	PPHT (€)	ECOPART (€)
267.0038.00	PIPE REGLABLE A SORTIE VERT.D100 UCWP33	U	42097.6	47,52	0,02

Nicoll
by aliaxis

PIPE POUR WC EN PVC
Longue à coller - Longue



	DÉSIGNATION	UT	CODE	PPHT (€)	ECOPART (€)
267.0026.63	PIPE LGUE 30CM D100 JT NEOPR.065/095 CTW1130	U	45624.4	33,31	0,02
267.0024.40	PIPE LGUE 40CM D093 JT NEOPR.085/107 CTW5540	U	17210.6	30,52	0,02

Nicoll
by aliaxis

PIPE POUR WC EN PVC
Longue à coller - Longue - Joint à lèvres en élastomère



	DÉSIGNATION	UT	CODE	PPHT (€)	ECOPART (€)
267.0032.72	PIPE LGUE D100 AV.PIQ.FEM.D40 085/107 CTWP40	U	42907.6	40,92	0,02

Nicoll
by aliaxis

MANCHETTE POUR WC EN PVC
Sortie droite - Réparation en PVC blanc



	DÉSIGNATION	UT	CODE	PPHT (€)	ECOPART (€)
267.0008.50	MANCHETTE REPARATION MF 093/100 BLC ZTTW	U	94816.6	10,65	0,02

Nicoll
by aliaxis

RACCORD POUR WC EN PVC
Raccord à coller - Sortie droite - Sortie femelle



	DÉSIGNATION	UT	CODE	PPHT (€)	ECOPART (€)
267.0017.38	SORTIE DRTE FEMELLE 85/107 D100 BLC QWF33	U	75709.6	21,75	0,02

Le PPHT comprend l'ecopart (€)

PVC EVACUATION

RACCORDS PVC SANITAIRE

Nicoll
by allaxis

RACCORD POUR WC EN PVC

Raccord à coller - Sortie droite excentrée



	DÉSIGNATION	UT	CODE	PPHT (€)	ECOPART (€)
267.0021.21	SORTIE DRTE EXCENTREE 87/107 D100 BLC QW810E	U	40827.8	26,53	0,02

Nicoll
by allaxis

RACCORD POUR WC EN PVC

Raccord à coller - Ensemble joint-bague



	DÉSIGNATION	UT	CODE	PPHT (€)	ECOPART (€)
267.0009.01	BAGUE ET JOINT 125MM P.PIPE WC BJWC3	U	33649.5	11,28	0,02

Nicoll
by allaxis

RACCORD POUR WC EN PVC

Raccord à coller - Rosace pour pipe de W.C



	DÉSIGNATION	UT	CODE	PPHT (€)	ECOPART (€)
267.0002.71	ROSACE P.PIPE WC D100 RTW	U	73078.8	3,41	0,02

Nicoll
by allaxis

RACCORD POUR WC

Tube de chasse pour réservoir WC - Type cuvette anglaise



	DÉSIGNATION	UT	CODE	PPHT (€)	ECOPART (€)
267.0021.62	TUBE CHASSE P.RESERVOIR D032 CA1	U	73059.8	27,05	0,02

Nicoll
by allaxis

RACCORD POUR WC

Queue de carpe



	DÉSIGNATION	UT	CODE	PPHT (€)	ECOPART (€)
267.0003.55	QUEUE DE CARPE D032 UEW	U	54228.2	4,46	0,02

SIAMP

PIPE POUR WC EN PVC

Longue - Coudée ø 100



	DÉSIGNATION	UT	CODE	PPHT (€)	ECOPART (€)
526.0008.40	PIPE LONGUE COUDEE P100 SIAMP 92200007	U	59581.9	11,22	0,02
526.0009.60	PIPE LONGUE COUDEE P100R SIAMP 92200107	U	49326.2	12,82	0,02

Le PPHT comprend l'ecopart (€)

PVC EVACUATION

RACCORDS PVC SANITAIRE

SIAMP

PIPE POUR WC EN PVC

Longue - Droite ø 100



	DÉSIGNATION	UT	CODE	PPHT (€)	ECOPART (€)
526.0010.58	PIPE LONGUE DROITE M100L SIAMP 92300007	U	49406.2	14,12	0,02
526.0004.95	PIPE CRTE DROIT.FEM/MALE M100C SIAMP 92301007	U	79276.2	6,62	0,02

SIAMP

PIPE POUR WC EN PVC

Longue - Extensible à mémoire de forme Femelle



	DÉSIGNATION	UT	CODE	PPHT (€)	ECOPART (€)
526.0033.82	PIPE ARTICULEE EPDM MF PA2555 SIAMP 92255510	U	6028L.1	45,12	0,02

SIAMP

PIPE POUR WC EN PVC

Courte - Coudée Femelle ø 100



	DÉSIGNATION	UT	CODE	PPHT (€)	ECOPART (€)
526.0007.58	PIPE COURTE COUDEE FEM.C100F SIAMP 92201007	U	59663.5	10,12	0,02

SIAMP

PIPE POUR WC EN PVC

Courte - Coudée Femelle ø 100 avec repiquage Femelle ø 40 mm



	DÉSIGNATION	UT	CODE	PPHT (€)	ECOPART (€)
526.0008.48	PIPE COURTE COUDEE FEM.C100FR SIAMP 92201107	U	53935.3	11,32	0,02

AERATION

Nicoll
by allaxis

CLAPET EQUILIBREUR DE PRESSION

Série AMG



	DÉSIGNATION	UT	CODE	PPHT (€)	ECOPART (€)
267.0018.70	CLAPET AERATEUR/EQUIL.SS DTA 32-40 AMG3240	U	183AJ.3	24,96	0,02
267.0046.73	CLAPET EQUIL.PRESSION PVC D063/050 AMG5063	U	184XM.8	62,33	0,02
267.0063.04	CLAPET AERATEUR/EQUIL.SS DTA 100-110 AMG100	U	183AK.1	84,07	0,02

PVC EVACUATION

REGARDS, SIPHONS ET CANIVEAUX

RECEVEUR SIPHONNE
Vertical

	DÉSIGNATION	UT	CODE	PPHT (€)	ECOPART (€)
000.0015.55	RECEVEUR SIPHONNE VERT.32-40 GIRPI RS132/40	U	12510.4	25,93	0,02

SIPHON DE COUR
Emboîture incorporée verticale

	DÉSIGNATION	UT	CODE	PPHT (€)	ECOPART (€)
257.0027.29	SIPHON DE COUR A EMB.15X15 SV.ANTH. SC456	U	79754.8	36,40	0,01
257.0027.29	SIPHON DE COUR A EMB.15X15 SV.SABLE SC456S	U	79757.1	36,40	0,01
257.0039.56	SIPHON DE COUR A EMB.20X20 SV.GRIS FCE SC089	U	38986.6	52,76	0,02
257.0039.56	SIPHON DE COUR A EMB.20X20 SV.SABLE SC089S	U	39136.7	52,76	0,02
257.0062.43	SIPHON DE COUR A EMB.25X25 SV.GRIS FCE SC891	U	79756.3	83,27	0,03
257.0062.43	SIPHON DE COUR A EMB.25X25 SV.SABLE SC891S	U	79761.3	83,27	0,03

SIPHONNETTE
Grille carrée - Sortie verticale ø 40/50 mm

	DÉSIGNATION	UT	CODE	PPHT (€)	ECOPART (€)
267.0011.51	SIPHONNETTE AV.GRIL.10X10 SV.40/50 BLC SIHJ10	U	07048.2	15,37	0,02

GRILLE DE SOL
Rabattable - Pour poste d'eau

	DÉSIGNATION	UT	CODE	PPHT (€)	ECOPART (€)
757.0040.26	GRILLE RABATTABLE P.POSTE D'EAU GRIS GPOSTO	U	58768.3	50,35	0,02

ASSAINISSEMENT

SIPHON DISCONNECTEUR
FF - Monobloc - Sans bouchon inférieur

	DÉSIGNATION	UT	CODE	PPHT (€)	ECOPART (€)
239.0110.47	SIPHON DISCONNECTEUR MONO A COLL.FF D100 YDT	U	79198.8	147,31	0,02
239.0115.43	SIPHON DISCONNECTEUR MONO A COLL.FF D125 YDX	U	08309.7	153,93	0,02

PVC EVACUATION

ASSAINISSEMENT

COUVERCLE POUR BOITE DE BRANCHEMENT ET REGARDS READYFIT
A baïonnette - Mâle, corps à coller

	DÉSIGNATION	UT	CODE	PPHT (€)
239.0093.47	COUVERCLE A BAIONNETTE MALE D315 COTEBM	U	55720.9	124,63

Pour plus d'infos,
consultez
le CAHIER TECHNIQUE
page 14

J+0 100% Dispo



**SCANNEZ,
commandez,**

Téléchargez sur



Disponible sur



DISPONIBLE SUR
Google play

FONTE

COLONNES ET RACCORDS FONTE EVACUATION



RACCORD KRONOS PUSH

Raccord pour tube en fer - Femelle



	DÉSIGNATION	UT	CODE	PPHT (€)
343.0017.85	RACCORD KRONOS PUSH F 3/8 E101N903P	U	9559Q.4	23,80
343.0019.32	RACCORD KRONOS PUSH F 1/2" E101N904P	U	9559W.1	25,76
343.0023.61	RACCORD KRONOS PUSH F 3/4 E101N905P	U	9559X.9	31,48
343.0028.89	RACCORD KRONOS PUSH F 1" E101N906P	U	9559Y.7	38,52
343.0043.56	RACCORD KRONOS PUSH F 1 1/4 E101N907P	U	9560E.0	58,08
343.0053.34	RACCORD KRONOS PUSH F 1 1/2 E101N908P	U	9560T.8	71,12
343.0080.13	RACCORD KRONOS PUSH F 2" E101N909P	U	9560E.8	106,84



RACCORD KRONOS PUSH

Raccord pour tube en fer - Mâle



	DÉSIGNATION	UT	CODE	PPHT (€)
343.0017.85	RACCORD KRONOS PUSH M 3/8 E102N963P	U	9560M.7	23,80
343.0019.32	RACCORD KRONOS PUSH M 1/2" E102N964P	U	9560N.5	25,76
343.0023.61	RACCORD KRONOS PUSH M 3/4" E102N965P	U	9560P.3	31,48
343.0028.89	RACCORD KRONOS PUSH M 1" E102N966P	U	9560Q.1	38,52
343.0043.56	RACCORD KRONOS PUSH M 1 1/4 E102N967P	U	9560S.7	58,08
343.0053.34	RACCORD KRONOS PUSH M 1 1/2 E102N968P	U	9560T.5	71,12
343.0080.13	RACCORD KRONOS PUSH M 2" E102N969P	U	9560U.2	106,84



RACCORD KRONOS PUSH

Raccord pour tube en fer - Double



	DÉSIGNATION	UT	CODE	PPHT (€)
340.0036.44	RACCORD KRONOS PUSH TUBE-TUBE 3/8 E103N923P	U	9560X.6	48,58
343.0035.01	RACCORD KRONOS PUSH TUBE-TUBE 1/2 E103N924P	U	9561S.1	46,68
343.0042.09	RACCORD KRONOS PUSH TUBE-TUBE 3/4 E103N925P	U	9561E.1	56,12
343.0054.69	RACCORD KRONOS PUSH TUBE-TUBE 1" E103N926P	U	9561F.9	72,92
343.0072.54	RACCORD KRONOS PUSH TUBE-TUBE 1 1/4 E103N927P	U	9561J.2	96,72
343.0091.89	RACCORD KRONOS PUSH TUBE-TUBE 1 1/2 E103N928P	U	9561K.0	122,52
343.0144.63	RACCORD KRONOS PUSH TUBE-TUBE 2" E103N929P	U	9561M.6	192,84



TUYAU SMU S

Effluents domestiques - Longueur 3 m - NF EN 877



	DÉSIGNATION	UT	CODE	PPHT (€)	ECOPART (€)
301.0087.51	TUYAU FONTE SMU-S 3M 50 156360	U	26547.0	116,69	0,01
301.0097.43	TUYAU FONTE SMU-S 3M 75 156452	U	57168.7	129,93	0,02

Le PPHT comprend l'ecopart (€)

FONTE

COLONNES ET RACCORDS FONTE EVACUATION



BOUCHON D'EXTREMITE SMU-S

Expansible



	DÉSIGNATION	UT	CODE	PPHT (€)	ECOPART (€)
301.0039.13	BOUCHON EXPANSIBLE SMU-S 50 156374	U	30533.4	52,18	0,01
301.0044.80	BOUCHON EXPANSIBLE SMU-S 75 156464	U	30536.7	59,75	0,01
301.0053.25	BOUCHON EXPANSIBLE SMU-S 100 156579	U	30537.5	71,01	0,01
301.0066.57	BOUCHON EXPANSIBLE SMU-S 125 156747	U	30538.3	88,77	0,01
301.0082.98	BOUCHON EXPANSIBLE SMU-S 150 156839	U	30540.9	110,65	0,01
301.0171.11	BOUCHON EXPANSIBLE SMU-S 200 156961	U	37554.3	228,16	0,01



COUDE SMU-S

22°



	DÉSIGNATION	UT	CODE	PPHT (€)	ECOPART (€)
301.0035.98	COUDE FONTE SMU-S 22 100 156598	U	43823.4	47,98	0,01
301.0041.74	COUDE FONTE SMU-S 22 125 156761	U	30412.1	55,67	0,01



COUDE SMU-S

45°



	DÉSIGNATION	UT	CODE	PPHT (€)	ECOPART (€)
301.0020.80	COUDE FONTE SMU-S 45 50 156384	U	43824.2	27,74	0,01
301.0022.49	COUDE FONTE SMU-S 45 75 156476	U	67774.0	30,00	0,01
301.0109.00	COUDE FONTE SMU-S 45 200 156970	U	17051.4	145,35	0,01
301.0254.66	COUDE FONTE SMU-S 45 250 157069	U	48359.4	339,56	0,01
301.0048.23	COUDE FONTE SMU 45 150 AGILIUM 285292	U	A02NS.4	64,32	0,01
301.0036.16	COUDE FONTE SMU 45 125 AGILIUM 285291	U	A02NR.6	48,23	0,01



COUDE SMU-S

88°



	DÉSIGNATION	UT	CODE	PPHT (€)	ECOPART (€)
301.0020.54	COUDE FONTE SMU-S 88 50 156379	U	43829.1	27,40	0,01
301.0025.00	COUDE FONTE SMU-S 88 75 156471	U	14946.8	33,35	0,01
301.0038.62	COUDE FONTE SMU-S 88 125 156752	U	67766.6	51,51	0,01
301.0053.10	COUDE FONTE SMU-S 88 150 156844	U	43830.9	70,81	0,01
301.0027.69	COUDE FONTE SMU 88 100 AGILIUM 283868	U	A02NU.9	36,93	0,01

FONTE

COLONNES ET RACCORDS FONTE EVACUATION



CULOTTE SMU-S

88° - Double - Parallèle



	DÉSIGNATION	UT	CODE	PPHT (€)	ECOPART (€)
301.0106.12	CULOTTE FONTE SMU-S DOUBLE 88 100 156704	U	19819.2	141,51	0,01



CULOTTE SMU-S

45° - Double - Equerre



	DÉSIGNATION	UT	CODE	PPHT (€)	ECOPART (€)
301.0165.22	CULOTTE FONTE DBLE EQUER. SMU-S 45 100 156716	U	66581.0	220,30	0,01



CULOTTE SMU-S

88° - double - équerre - diamètre intérieur



	DÉSIGNATION	UT	CODE	PPHT (€)	ECOPART (€)
301.0235.05	CULOTTE FONTE DBLE EQUER. SMU-S 88 100 156712	U	56666.9	235,06	0,01



CULOTTE SMU-S

45° - Simple



	DÉSIGNATION	UT	CODE	PPHT (€)	ECOPART (€)
301.0039.13	CULOTTE FONTE SMU-S SIMPLE 45 75 156544	U	67771.6	52,18	0,01
301.0035.66	CULOTTE FONTE SMU-S SIMPLE 45 50 156435	U	43878.8	47,56	0,01
301.0119.44	CULOTTE FONTE SMU-S SIMPLE 45 150 156931	U	67773.2	159,27	0,01
301.0256.33	CULOTTE FONTE SMU-S SIMPLE 45 200 157030	U	07733.9	341,78	0,01
301.0664.80	CULOTTE FONTE SMU-S SIMPLE 45 250 157106	U	48358.6	886,43	0,03



CULOTTE SMU-S

68° - Simple



	DÉSIGNATION	UT	CODE	PPHT (€)	ECOPART (€)
301.0054.26	CULOTTE FONTE SMU-S SIMPLE 68 100 156699	U	67612.2	72,36	0,01



CULOTTE SMU-S

88° - Simple



	DÉSIGNATION	UT	CODE	PPHT (€)	ECOPART (€)
301.0038.16	CULOTTE FONTE SMU-S SIMPLE 88 50 156431	U	43895.2	50,89	0,01
301.0040.89	CULOTTE FONTE SMU-S SIMPLE 88 75 156538	U	07792.5	54,53	0,01

FONTE

COLONNES ET RACCORDS FONTE EVACUATION



CULOTTE SMU-S

88° - Simple

- suite



	DÉSIGNATION	UT	CODE	PPHT (€)	ECOPART (€)
301.0082.34	CULOTTE FONTE SMU-S SIMPLE 88 125 156809	U	14952.6	109,79	0,01
301.0119.81	CULOTTE FONTE SMU-S SIMPLE 88 150 156925	U	43897.8	159,76	0,01
301.0048.80	CULOTTE FONTE SMU SIMPLE 88 100 AGUL 283870	U	A02NX.3	65,08	0,01



CONE EXCENTRE SMU-S

Réduit



	DÉSIGNATION	UT	CODE	PPHT (€)	ECOPART (€)
301.0027.12	CONE EXCENTRE SMU-S 75X50 156424	U	43969.5	36,17	0,01
301.0036.25	CONE EXCENTRE SMU-S 100X50 156426	U	11652.5	47,01	0,01
301.0035.25	CONE EXCENTRE SMU-S 100X75 156526	U	14953.4	47,01	0,01
301.0037.94	CONE EXCENTRE SMU-S 125X50 156428	U	85641.2	50,60	0,01
301.0037.94	CONE EXCENTRE SMU-S 125X100 156684	U	14954.2	50,60	0,01
301.0051.53	CONE EXCENTRE SMU-S 150X100 156686	U	11653.3	68,72	0,01
301.0051.53	CONE EXCENTRE SMU-S 150X125 156805	U	11655.8	68,72	0,01
301.0103.05	CONE EXCENTRE SMU-S 200X100 156688	U	11654.1	137,41	0,01
301.0103.05	CONE EXCENTRE SMU-S 200X125 156807	U	11656.6	137,41	0,01
301.0103.05	CONE EXCENTRE SMU-S 200X150 156919	U	11657.4	137,41	0,01



EMBRANCHEMENT SMU-S

45° - Simple



	DÉSIGNATION	UT	CODE	PPHT (€)	ECOPART (€)
301.0053.10	EMBRANCHEMENT SMU-S SPLE 45 100X50 156618	U	43909.1	70,81	0,01
301.0050.98	EMBRANCHEMENT SMU-S SPLE 45 100X75 156625	U	11662.4	67,99	0,01
301.0121.31	EMBRANCHEMENT SMU-S SPLE 45 150X100 156879	U	43910.9	161,76	0,01
301.0124.44	EMBRANCHEMENT SMU-S SPLE 45 150X125 156883	U	11663.2	165,93	0,01
301.0258.54	EMBRANCHEMENT SMU-S SPLE 45 200X100 156982	U	43911.7	344,73	0,01



JOINT SMU-S

Pose en manchon



	DÉSIGNATION	UT	CODE	PPHT (€)	ECOPART (€)
302.0008.98	JOINT SMU PAM DN 50 229384	U	29596.4	11,98	0,01
302.0010.60	JOINT SMU PAM DN 75 229386	U	2959A.5	14,15	0,01
302.0012.30	JOINT SMU PAM DN 100 229387	U	2959C.1	16,41	0,01
302.0014.80	JOINT SMU PAM DN 125 230135	U	29602.0	19,74	0,01
302.0017.62	JOINT SMU PAM DN 150 230136	U	29603.8	23,50	0,01
302.0036.58	JOINT SMU PAM DN 200 230137	U	29609.5	48,78	0,01

Le PPHT comprend l'ecopart (€)

FONTE

COLONNES ET RACCORDS FONTE EVACUATION



JOINT SMU-S

SMU Inox Rénovation - A ouverture totale



	DÉSIGNATION	UT	CODE	PPHT (€)	ECOPART (€)
302.0022.92	JOINT SMU INOX PAM RENOVATION DN100 233901	U	0578U.1	30,57	0,01
302.0026.93	JOINT SMU INOX PAM RENOVATION DN125 233902	U	0578V.9	35,92	0,01
302.0032.88	JOINT SMU INOX PAM RENOVATION DN150 233903	U	0578W.7	43,85	0,01



JOINT SMU-S

Rapid S



	DÉSIGNATION	UT	CODE	PPHT (€)	ECOPART (€)
302.0080.38	JOINT RAPID S DN 250 228759	U	29628.5	107,18	0,01



RACCORD SMU-S

Tampon EPDM - 1 trou



	DÉSIGNATION	UT	CODE	PPHT (€)	ECOPART (€)
302.0025.00	TAMPON EPDM GAMME SMU-S/SMU PLUS 50 156394	U	43966.1	33,35	0,01
302.0035.60	TAMPON EPDM GAMME SMU-S/SMU PLUS 75 156492	U	43967.9	47,47	0,01



RACCORD SMU-S

Tampon EPDM - 2 trous



	DÉSIGNATION	UT	CODE	PPHT (€)	ECOPART (€)
302.0043.48	TAMPON EPDM SMU-S/SMU PLUS 2TROUS 100 156628	U	43968.7	57,99	0,01



TUYAU SME AGILIUM

Anticorrosion - NF EN 877



	DÉSIGNATION	UT	CODE	PPHT (€)	ECOPART (€)
301.0194.42	TUYAU FONTE SMU 3M AGILIUM 150 283725	U	A008T.2	259,26	0,03
301.0152.42	TUYAU FONTE SMU 3M AGILIUM 125 283724	U	A008S.4	203,24	0,02
301.0109.21	TUYAU FONTE SMU 3M AGILIUM 100 283723	U	A008Q.8	145,62	0,01
301.0347.62	TUYAU FONTE SMU AGILIUM DN200 3M 283726	U	A008U.9	463,53	0,04



TUYAU SME L

Anticorrosion - NF EN 877



	DÉSIGNATION	UT	CODE	PPHT (€)	ECOPART (€)
302.0216.42	TUYAU FONTE SME L 2M D125 155187	U	03120.3	288,58	0,02



Le PPHT comprend l'ecopart (€)

FONTE

COLONNES ET RACCORDS FONTE EVACUATION



TUYAU SME L

Anticorrosion - NF EN 877

- suite



	DÉSIGNATION	UT	CODE	PPHT (€)	ECOPART (€)
302.0138.49	TUYAU FONTE SME L 2M D75 155172	U	03118.7	184,66	0,01
302.0155.82	TUYAU FONTE SME L 3M D75 155174	U	03132.8	207,78	0,02
302.0160.16	TUYAU FONTE SME L 2M D100 155178	U	03119.5	213,56	0,02
302.0187.54	TUYAU FONTE SME L 3M D100 155180	U	03133.6	250,08	0,02



COUDE SME

45°



	DÉSIGNATION	UT	CODE	PPHT (€)	ECOPART (€)
302.0040.42	COUDE FONTE SME A 45 100 156111	U	03155.9	53,90	0,01
302.0070.77	COUDE FONTE SME A 45 125 156171	U	03156.7	94,37	0,01



COUDE SME

88°



	DÉSIGNATION	UT	CODE	PPHT (€)	ECOPART (€)
302.0040.44	COUDE FONTE SME A 88 100 156109	U	03148.4	53,93	0,01



CULOTTE SME

45° - Simple



	DÉSIGNATION	UT	CODE	PPHT (€)	ECOPART (€)
302.0063.49	CULOTTE FONTE SME SIMPLE 45 75 156092	U	03165.8	84,66	0,01
302.0077.97	CULOTTE FONTE SME SIMPLE 45 100 156151	U	03166.6	103,97	0,01
302.0134.22	CULOTTE FONTE SME SIMPLE 45 125 156019	U	03167.4	178,97	0,01



CULOTTE SME

88° - Simple



	DÉSIGNATION	UT	CODE	PPHT (€)	ECOPART (€)
302.0080.82	CULOTTE FONTE SME SIMPLE 88 100 156147	U	25223.9	107,77	0,01

FONTE

COLONNES ET RACCORDS FONTE EVACUATION



JOINT SME SME "JC"



	DÉSIGNATION	UT	CODE	PPHT (€)	ECOPART (€)
302.0009.33	JOINT SME JC DN75 261497	U	229AZ.4	9,34	0,01
302.0007.18	JOINT SME JC DN100 261498	U	206FX.0	9,59	0,01
302.0012.81	JOINT SME JC DN125 261499	U	277MV.8	17,09	0,01



JOINT SME SME "JL" pour WC



	DÉSIGNATION	UT	CODE	PPHT (€)	ECOPART (€)
302.0017.84	JOINT SME JL POUR WC 100 156132	U	26880.5	23,79	0,01



RACCORD SME Coulisse



	DÉSIGNATION	UT	CODE	PPHT (€)	ECOPART (€)
302.0075.07	COULISSE FONTE 75 156079	U	03241.7	100,10	0,01
302.0082.25	COULISSE FONTE 100 156135	U	03242.5	109,68	0,01



RACCORD SME Tampon EPDM



	DÉSIGNATION	UT	CODE	PPHT (€)	ECOPART (€)
302.0036.50	TAMPON EPDM POUR GAMME SME 100 3 TROUS 156131	U	25926.7	48,68	0,01



TUYAU SMU PLUS Effluents agressifs - Longueur 3 m - NF EN 877



	DÉSIGNATION	UT	CODE	PPHT (€)	ECOPART (€)
301.0132.07	TUYAU FONTE SMU PLUS 3M 50 155301	U	08960.7	176,10	0,01
301.0169.40	TUYAU FONTE SMU PLUS 3M 100 155347	U	63046.7	225,88	0,02
301.0236.30	TUYAU FONTE SMU PLUS 3M 125 155390	U	65491.3	315,09	0,03
301.0286.15	TUYAU FONTE SMU PLUS 3M 150 155412	U	16164.6	381,57	0,04

FONTE

COLONNES ET RACCORDS FONTE EVACUATION



BOUCHON D'EXTREMITE SMU-PLUS Expansible



	DÉSIGNATION	UT	CODE	PPHT (€)	ECOPART (€)
301.0061.04	BOUCHON EXPANSIBLE SMU PLUS 50 155303	U	08962.3	81,40	0,01
301.0088.48	BOUCHON EXPANSIBLE SMU PLUS 100 155351	U	63067.3	117,98	0,01
301.0103.46	BOUCHON EXPANSIBLE SMU PLUS 125 155392	U	65507.6	137,96	0,01



COUDE SMU PLUS 45°



	DÉSIGNATION	UT	CODE	PPHT (€)	ECOPART (€)
301.0033.70	COUDE FONTE SMU PLUS 45 50 155306	U	08966.4	44,94	0,01
301.0044.18	COUDE FONTE SMU PLUS 45 100 155356	U	63048.3	58,91	0,01
301.0065.98	COUDE FONTE SMU PLUS 45 125 155395	U	72730.5	87,99	0,01
301.0079.51	COUDE FONTE SMU PLUS 45 150 155420	U	16167.9	106,02	0,01



COUDE SMU PLUS 88°



	DÉSIGNATION	UT	CODE	PPHT (€)	ECOPART (€)
301.0035.30	COUDE FONTE SMU PLUS 88 50 155304	U	08967.2	47,07	0,01
301.0046.27	COUDE FONTE SMU PLUS 88 100 155353	U	04772.0	61,70	0,01



CULOTTE SMU PLUS 45° - Simple



	DÉSIGNATION	UT	CODE	PPHT (€)	ECOPART (€)
301.0055.23	CULOTTE SMU PLUS SIMPLE 45 50 155316	U	09036.5	73,65	0,01
301.0063.17	CULOTTE SMU PLUS SIMPLE 45 75 155344	U	72744.6	84,24	0,01
301.0082.28	CULOTTE SMU PLUS SIMPLE 45 100 155380	U	72745.3	109,72	0,01
301.0133.62	CULOTTE SMU PLUS SIMPLE 45 125 155409	U	72746.1	178,17	0,01
301.0195.64	CULOTTE SMU PLUS SIMPLE 45 150 155442	U	72747.9	260,86	0,01



CULOTTE SMU PLUS 88° - Simple



	DÉSIGNATION	UT	CODE	PPHT (€)	ECOPART (€)
301.0097.32	CULOTTE SMU PLUS SIMPLE 88 100 155378	U	04781.1	129,77	0,01

Le PPHT comprend l'ecopart (€)

FONTE

COLONNES ET RACCORDS FONTE EVACUATION



CONE EXCENTRE SMU-PLUS

Réduit



	DÉSIGNATION	UT	CODE	PPHT (€)	ECOPART (€)
301.0054.71	CONE EXCENTRE SMU PLUS 75-50 155312	U	09015.9	72,96	0,01
301.0058.78	CONE EXCENTRE SMU PLUS 100-50 155313	U	09028.2	78,38	0,01
301.0058.78	CONE EXCENTRE SMU PLUS 100-75 155337	U	72718.0	78,38	0,01
301.0072.81	CONE EXCENTRE SMU PLUS 125-50 173808	U	81496.0	97,09	0,01
301.0065.30	CONE EXCENTRE SMU PLUS 125-100 155374	U	65515.9	87,08	0,01
301.0081.53	CONE EXCENTRE SMU PLUS 150-125 155405	U	65516.7	108,72	0,01



EMBRANCHEMENT SMU PLUS

45° - Simple



	DÉSIGNATION	UT	CODE	PPHT (€)	ECOPART (€)
301.0091.28	EMBRANCHEMENT SMU PLUS SPLE 45 100X50 155365	U	13365.2	121,71	0,01
301.0146.40	EMBRANCHEMENT SMU PLUS SPLE 45 125X100 155400	U	72734.7	195,21	0,01
301.0079.52	EMBRANCHEMENT SMU SPL 45 125X100 AGIL 285296	U	A02NV.7	106,04	0,01



JOINT SMU PLUS

SMU Inox - Pose en manchon



	DÉSIGNATION	UT	CODE	PPHT (€)	ECOPART (€)
302.0018.10	JOINT SMU INOX PAM DN 50 229389	U	2960B.0	24,14	0,01
302.0018.69	JOINT SMU INOX PAM DN 75 229390	U	29612.9	24,93	0,01
302.0022.92	JOINT SMU INOX PAM DN 100 229391	U	29613.7	30,57	0,01
302.0026.93	JOINT SMU INOX PAM DN 125 230138	U	2961H.6	35,92	0,01
302.0032.88	JOINT SMU INOX PAM DN 150 230139	U	29611.4	43,85	0,01



RACCORD SMU-PLUS

Tampon EPDM - 3 trous - Mixte sans collier de serrage



	DÉSIGNATION	UT	CODE	PPHT (€)	ECOPART (€)
302.0046.23	TAMPON EPDM SMU-S/SMU+ 3TROUS 100 156629	U	30913.8	61,65	0,01



RACCORD SMU

Bague élastomère



	DÉSIGNATION	UT	CODE	PPHT (€)	ECOPART (€)
302.0014.79	BAGUE COMPENSATION FTE/MATERIAUX 50 156399	U	71436.0	19,73	0,01
302.0018.03	BAGUE COMPENSATION FTE/MATERIAUX 75 156494	U	23038.3	24,05	0,01
302.0020.89	BAGUE COMPENSATION FTE/MATERIAUX 100 156635	U	79200.2	27,86	0,01
302.0025.96	BAGUE COMPENSATION FTE/MATERIAUX 125 156778	U	06624.1	34,62	0,01

Le PPHT comprend l'ecopart (€)

FONTE

COLONNES ET RACCORDS FONTE EVACUATION



RACCORD SMU

Bague élastomère - suite



	DÉSIGNATION	UT	CODE	PPHT (€)	ECOPART (€)
302.0055.32	BAGUE COMPENSATION FTE/MATERIAUX 200 157000	U	84369.8	73,77	0,01



RACCORD SMU

WC EPDM - Raccordement direct WC ne nécessitant pas de collier de serrage



	DÉSIGNATION	UT	CODE	PPHT (€)	ECOPART (€)
302.0031.54	RACCORDMENT SMU / WC 100 156654	U	43973.7	42,07	0,01



PLAQUE HERMETIQUE

SME - Kit (plaque + joint + vis + écrous)



	DÉSIGNATION	UT	CODE	PPHT (€)	ECOPART (€)
302.0037.50	PLAQUE HERMETIQUE FONTE -KIT- 75 207456	U	53783.7	50,01	0,01
302.0046.17	PLAQUE HERMETIQUE FONTE -KIT- 100 207457	U	53784.5	61,57	0,01
302.0057.74	PLAQUE HERMETIQUE FONTE -KIT- 125 207458	U	78391.0	76,99	0,01

Pour plus d'infos,
consultez
le CAHIER TECHNIQUE
page 14

PVC PRESSION

TUBES ET RACCORDS PVC PRESSION



TUBE PVC

Eau potable - Tulipe 6 M



	DÉSIGNATION	UT	CODE	PPHT (€)
250.0016.88	TUBE PVC TULIPE 10 B 6M 110X5.3 (99.4)	M	66116.5	28,13
250.0014.32	TUBE PVC TULIPE 10 B 6M 125X6.0 (113)	M	44473.7	23,86
250.0022.84	TUBE PVC TULIPE 10 B 6M 140X6.1 (127.8)	M	15115.9	38,06
250.0023.56	TUBE PVC TULIPE 10 B 6M 160X6.2 (147.6)	M	15116.7	39,26
250.0043.92	TUBE PVC TULIPE 10 B 6M 200X7.7 (184.6)	M	15125.8	73,20
250.0009.42	TUBE PVC TULIPE 16 B 6M 75X5.6 (64)	M	16118.2	15,70
250.0015.61	TUBE PVC TULIPE 16 B 6M 90X6.7 (76.8)	M	16120.8	26,02



TUBE PREMANCHONNE

En barre



	DÉSIGNATION	UT	CODE	PPHT (€)
250.0001.93	TUBE PVC TULIPE 16 B 6M 32X2.4 (27.2)	M	16111.7	3,22
250.0003.11	TUBE PVC TULIPE 16 B 6M 40X3.0 (34)	M	16113.3	5,18
250.0004.78	TUBE PVC TULIPE 16 B 6M 50X3.7 (42.6)	M	16115.8	7,97
250.0008.29	TUBE PVC TULIPE 16 B 6M 63X4.7 (53.6)	M	16116.6	13,82
250.0002.03	TUBE PVC TULIPE 25 B 6M 20X2.3 (15.4)	M	16106.7	3,38
250.0002.31	TUBE PVC TULIPE 25 B 6M 25X2.8 (19.4)	M	16108.3	3,85



BOUCHON A COLLER PVC

Femelle



	DÉSIGNATION	UT	CODE	PPHT (€)
238.0001.22	BOUCHON A COLLER PVC PR F 20	U	02900.9	1,74
238.0001.67	BOUCHON A COLLER PVC PR F 25	U	02901.7	2,38
238.0002.33	BOUCHON A COLLER PVC PR F 32	U	21205.0	3,33
238.0003.09	BOUCHON A COLLER PVC PR F 40	U	21232.4	4,41
238.0003.84	BOUCHON A COLLER PVC PR F 50	U	21233.2	5,49
238.0005.57	BOUCHON A COLLER PVC PR F 63	U	02902.5	7,95
238.0011.29	BOUCHON A COLLER PVC PR F 75	U	21234.0	16,13
238.0016.13	BOUCHON A COLLER PVC PR F 90	U	02903.3	23,04
238.0030.30	BOUCHON A COLLER PVC PR F 110	U	21339.7	43,28



BRIDE A COLLER PVC

Bride libre PN 10-16



	DÉSIGNATION	UT	CODE	PPHT (€)
238.0005.96	BRIDE LIBRE PVC PR PN10-16 50	U	4443F.4	8,51

PVC PRESSION

TUBES ET RACCORDS PVC PRESSION



BRIDE A COLLER PVC

Bride libre PN 10-16

- suite



	DÉSIGNATION	UT	CODE	PPHT (€)
238.0006.53	BRIDE LIBRE PVC PR PN10-16 63	U	4443G.2	9,33
238.0006.97	BRIDE LIBRE PVC PR PN10-16 75	U	4443H.0	9,95
238.0008.13	BRIDE LIBRE PVC PR PN10-16 90	U	4443I.8	11,62
238.0014.06	BRIDE LIBRE PVC PR PN10-16 110	U	4443J.7	20,09
238.0019.10	BRIDE LIBRE PVC PR PN10-16 125	U	4443K.5	27,29
238.0021.05	BRIDE LIBRE PVC PR PN10-16 140	U	4443L.3	30,07
238.0021.68	BRIDE LIBRE PVC PR PN10-16 160	U	44448.9	30,97
238.0034.45	BRIDE LIBRE PVC PR PN10-16 200	U	4444A.4	49,21



COUDE A COLLER PVC

FF - 45°



	DÉSIGNATION	UT	CODE	PPHT (€)
238.0002.30	COUDE PVC PR 45 FF 20	U	02890.2	3,29
238.0002.59	COUDE PVC PR 45 FF 25	U	02891.0	3,70
238.0002.89	COUDE PVC PR 45 FF 32	U	02892.8	4,13
238.0004.51	COUDE PVC PR 45 FF 40	U	02893.6	6,44
238.0003.81	COUDE PVC PR 45 FF 50	U	02894.4	5,45
238.0007.41	COUDE 45 FF A COLLER PVC PRESSION 63	U	21065.8	10,58
238.0019.84	COUDE PVC PR 45 FF 75	U	21070.8	28,34
238.0026.89	COUDE PVC PR 45 FF 90	U	21085.6	38,41
238.0039.87	COUDE PVC PR 45 FF 110	U	21117.7	56,95
238.0056.38	COUDE PVC PR 45 FF 125	U	02895.1	80,54
238.0061.27	COUDE PVC PR 45 FF 160	U	4440J.0	87,53
238.0108.39	COUDE PVC PR 45 FF 200	U	4440K.8	154,85



COUDE A COLLER PVC

FF - 90°



	DÉSIGNATION	UT	CODE	PPHT (€)
238.0001.34	COUDE PVC PR 90 FF 20	U	21120.1	1,91
238.0001.81	COUDE PVC PR 90 FF 25	U	21121.9	2,58
238.0002.61	COUDE PVC PR 90 FF 32	U	02887.8	3,73
238.0003.70	COUDE PVC PR 90 FF 40	U	02888.6	5,29
238.0003.77	COUDE PVC PR 90 FF 50	U	21178.9	5,38
238.0007.01	COUDE PVC PR 90 FF 63	U	21179.7	10,02
238.0017.30	COUDE PVC PR 90 FF 75	U	20977.5	24,71
238.0027.13	COUDE PVC PR 90 FF 90	U	21010.4	38,76
238.0042.57	COUDE PVC PR 90 FF 110	U	21046.8	60,81
238.0057.01	COUDE PVC PR 90 FF 125	U	02889.4	81,44
238.0058.44	COUDE PVC PR 90 FF 140	U	1821F.2	83,48

PVC PRESSION

TUBES ET RACCORDS PVC PRESSION



COUDE A COLLER PVC FF - 90° - suite



	DÉSIGNATION	UT	CODE	PPHT (€)
238.0073.44	COUDE PVC PR 90 FF 160	U	4440D.2	104,92
238.0111.31	COUDE PVC PR 90 FF 200	U	4440E.9	159,01



COLLET A COLLER PVC Strié pour bride



	DÉSIGNATION	UT	CODE	PPHT (€)
238.0006.25	COLLET STRIE PVC PR 50	U	23376.7	8,93
238.0009.05	COLLET STRIE PVC PR 63	U	23423.7	12,93
238.0013.17	COLLET STRIE PVC PR 75	U	88715.8	18,82
238.0012.47	COLLET STRIE PVC PR 90	U	88718.2	17,82
238.0016.26	COLLET STRIE PVC PR 110	U	18182.6	23,23
238.0034.69	COLLET STRIE PVC PR 125	U	18212.1	49,55
238.0041.84	COLLET STRIE PVC PR 140	U	22499.8	59,77
238.0054.43	COLLET STRIE PVC PR 160	U	22597.9	77,76
238.0042.89	COLLET STRIE PVC PR 200	U	4442C.2	61,27



MANCHON A COLLER PVC FF



	DÉSIGNATION	UT	CODE	PPHT (€)
238.0001.41	MANCHON PVC PR A COLLER F 20	U	02897.7	2,01
238.0001.63	MANCHON PVC PR A COLLER F 25	U	21206.8	2,33
238.0001.87	MANCHON PVC PR A COLLER F 32	U	02898.5	2,67
238.0002.71	MANCHON PVC PR A COLLER F 40	U	21207.6	3,87
238.0003.28	MANCHON PVC PR A COLLER F 50	U	21208.4	4,68
238.0005.57	MANCHON PVC PR A COLLER F 63	U	21220.9	7,96
238.0010.28	MANCHON PVC PR A COLLER F 75	U	21221.7	14,69
238.0015.25	MANCHON PVC PR A COLLER F 90	U	21156.5	21,79
238.0027.86	MANCHON PVC PR A COLLER F 110	U	21153.2	39,80
238.0038.74	MANCHON PVC PR A COLLER F 125	U	21368.6	55,34
238.0038.19	MANCHON PVC PR A COLLER F 160	U	4439H.6	54,55
238.0032.45	MANCHON PVC PR A COLLER F 140	U	44396.8	46,35
238.0067.17	MANCHON PVC PR A COLLER F 200	U	44391.4	95,96

PVC PRESSION

TUBES ET RACCORDS PVC PRESSION



MANCHON A COLLER / A VISSER PVC MF - Taraudé - Avec bague métallique de renfort



	DÉSIGNATION	UT	CODE	PPHT (€)
238.0004.70	EMBOUT TARAUDE PVC PR M A COLLER 20-1/2	U	21955.0	6,72
238.0005.28	EMBOUT TARAUDE PVC PR M A COLLER 25-3/4	U	21956.8	7,54
238.0006.45	EMBOUT TARAUDE PVC PR M A COLLER 32-1	U	21951.9	9,22
238.0009.58	EMBOUT TARAUDE PVC PR M A COLLER 40-1 1/4	U	21952.7	13,69
238.0011.75	EMBOUT TARAUDE PVC PR M A COLLER 50-1 1/2	U	21953.5	16,78
238.0018.80	EMBOUT TARAUDE PVC PR M A COLLER 63-2	U	21954.3	26,86



UNION A COLLER PVC FF - 3 pièces



	DÉSIGNATION	UT	CODE	PPHT (€)
238.0007.32	UNION 3 PIECES PVC PR FF 20	U	21562.4	10,46
238.0006.21	UNION 3 PIECES PVC PR FF 25	U	21555.8	8,87
238.0007.88	UNION 3 PIECES PVC PR FF 32	U	21556.6	11,26
238.0010.39	UNION 3 PIECES PVC PR FF 40	U	21557.4	14,84
238.0011.26	UNION 3 PIECES PVC PR FF 50	U	21558.2	16,09
238.0016.86	UNION 3 PIECES PVC PR FF 63	U	21559.0	24,09
238.0071.83	UNION 3 PIECES PVC PR FF 75	U	37776.2	102,61
238.0082.85	UNION 3 PIECES PVC PR FF 90	U	88706.7	118,36



REDUCTION A COLLER PVC MF - Interne



	DÉSIGNATION	UT	CODE	PPHT (€)
238.0001.43	MAMELON DE REDUCTION COURT PVC PR MF 25/20	U	20851.2	2,04
238.0001.84	MAMELON DE REDUCTION COURT PVC PR MF 32/25	U	02863.9	2,63
238.0002.80	MAMELON DE REDUCTION COURT PVC PR MF 40/32	U	02864.7	4,00
238.0002.07	MAMELON DE REDUCTION COURT PVC PR MF 50/40	U	02865.4	2,96
238.0005.17	MAMELON DE REDUCTION COURT PVC PR MF 63/32	U	57790.8	7,39
238.0005.17	MAMELON DE REDUCTION COURT PVC PR MF 63/40	U	41643.8	7,39
238.0003.12	MAMELON DE REDUCTION COURT PVC PR MF 63/50	U	02866.2	4,46
238.0008.28	MAMELON DE REDUCTION COURT PVC PR MF 75/50	U	57793.2	11,83
238.0008.28	MAMELON DE REDUCTION COURT PVC PR MF 75/63	U	20889.2	11,83
238.0011.89	MAMELON DE REDUCTION COURT PVC PR MF 90/50	U	57797.3	16,99
238.0018.34	MAMELON DE REDUCTION COURT PVC PR MF 110/90	U	02867.0	26,20
238.0021.15	MAMELON DE REDUCTION COURT PVC PR MF 125/110	U	02868.8	30,22
238.0017.80	MAMELON DE REDUCTION COURT PVC PR MF 140/110	U	44425.7	25,43
238.0024.05	MAMELON DE REDUCTION COURT PVC PR MF 160/110	U	44429.9	34,36
238.0029.37	MAMELON DE REDUCTION COURT PVC PR MF 160/125	U	48789.2	41,95

PVC PRESSION

TUBES ET RACCORDS PVC PRESSION

REDUCTION A COLLER PVC
 MF - Conique

	DÉSIGNATION	UT	CODE	PPHT (€)
238.0002.74	MAMELON DE REDUCTION PVC PR MF 32/20	U	02870.4	3,91
238.0003.95	MAMELON DE REDUCTION PVC PR MF 40/20	U	02872.0	5,64
238.0003.95	MAMELON DE REDUCTION PVC PR MF 40/25	U	20682.1	5,64
238.0004.89	MAMELON DE REDUCTION PVC PR MF 50/25	U	02874.6	6,98
238.0001.57	MAMELON DE REDUCTION PVC PR MF 50/32	U	20729.0	2,25
238.0006.51	MAMELON DE REDUCTION PVC PR MF 63/25	U	02877.9	9,30
238.0014.11	MAMELON DE REDUCTION PVC PR MF 90/63	U	02882.9	20,16
238.0014.11	MAMELON DE REDUCTION PVC PR MF 90/75	U	00003.4	20,16

REDUCTION A COLLER / A VISSER PVC
 MF

	DÉSIGNATION	UT	CODE	PPHT (€)
238.0002.91	EMBOUT FILETE F.M.A COLLER PVC PR 20/25-3/4	U	02914.0	4,15
238.0001.96	EMBOUT FILETE F.M.A COLLER PVC PR 25/32-3/4	U	02907.4	3,27
238.0003.51	EMBOUT FILETE F.M.A COLLER PVC PR 25/32-1	U	02915.7	5,02
238.0004.65	EMBOUT FILETE F.M.A COLLER PVC PR 32/40-1 1/4	U	02916.5	6,64
238.0004.56	EMBOUT FILETE F.M.A COLLER PVC PR 40/50-1 1/4	U	02909.0	6,51
238.0005.68	EMBOUT FILETE F.M.A COLLER PVC PR 40/50-1 1/2	U	02917.3	8,11
238.0004.98	EMBOUT FILETE F.M.A COLLER PVC PR 50/63-1 1/2	U	02910.8	7,11
238.0005.46	EMBOUT FILETE F.M.A COLLER PVC PR 50/63-2	U	02918.1	7,80
238.0007.83	EMBOUT FILETE F.M.A COLLER PVC PR 63/75-2	U	02911.6	11,18
238.0014.84	EMBOUT FILETE F.M.A COLLER PVC PR 75/90-2 1/2	U	54768.7	21,20
238.0012.39	EMBOUT FILETE F.M.A COLLER PVC PR 75/90- 3	U	4444E.5	17,70
238.0015.25	EMBOUT FILETE F.M.A COLLER PVC PR 90/110- 4	U	4444F.3	21,78

TE A COLLER PVC
 FFF - Egal

	DÉSIGNATION	UT	CODE	PPHT (€)
238.0002.07	TE DROIT PVC PR 90 FF 20	U	02821.7	2,96
238.0002.46	TE DROIT PVC PR 90 FF 25	U	02822.5	3,51
238.0003.20	TE DROIT PVC PR 90 FF 32	U	02823.3	4,57
238.0004.82	TE DROIT PVC PR 90 FF 40	U	02824.1	6,89
238.0005.76	TE DROIT PVC PR 90 FF 50	U	20566.6	8,23
238.0009.14	TE DROIT PVC PR 90 FF 63	U	02825.8	13,06
238.0021.42	TE DROIT PVC PR 90 FF 75	U	20592.2	30,60
238.0038.83	TE DROIT PVC PR 90 FF 90	U	20600.3	55,47
238.0049.17	TE DROIT PVC PR 90 FF 110	U	20601.1	70,25
238.0070.03	TE DROIT PVC PR 90 FF 125	U	02826.6	100,04
238.0065.95	TE DROIT PVC PR 90 FF 140	U	4439L.9	94,22
238.0078.04	TE DROIT PVC PR 90 FF 160	U	44405.9	111,48

PVC PRESSION

TUBES ET RACCORDS PVC PRESSION

TE A COLLER PVC
 FFF - Egal
 - suite

	DÉSIGNATION	UT	CODE	PPHT (€)
238.0225.84	TE DROIT PVC PR 90 FF 200	U	44406.7	322,63

TE A COLLER PVC
 FFF - Réduit

	DÉSIGNATION	UT	CODE	PPHT (€)
238.0003.55	TE DROIT REDUIT PVC PR 90 FF 25/20	U	02828.2	5,07
238.0004.56	TE DROIT REDUIT PVC PR 90 FF 32/25	U	02830.8	6,51
238.0007.15	TE DROIT REDUIT PVC PR 90 FF 40/20	U	02835.7	10,21
238.0007.15	TE DROIT REDUIT PVC PR 90 FF 40/25	U	02834.0	10,21
238.0006.13	TE DROIT REDUIT PVC PR 90 FF 40/32	U	02833.2	10,21
238.0010.74	TE DROIT REDUIT PVC PR 90 FF 50/20	U	02839.9	15,34
238.0010.74	TE DROIT REDUIT PVC PR 90 FF 50/25	U	02838.1	15,34
238.0010.74	TE DROIT REDUIT PVC PR 90 FF 50/32	U	02837.3	15,34
238.0008.72	TE DROIT REDUIT PVC PR 90 FF 50/40	U	02836.5	12,46
238.0017.49	TE DROIT REDUIT PVC PR 90 FF 63/25	U	02843.1	24,99
238.0019.99	TE DROIT REDUIT PVC PR 90 FF 63/32	U	02842.3	24,99
238.0013.86	TE DROIT REDUIT PVC PR 90 FF 63/50	U	02840.7	19,80
238.0015.01	TE DROIT REDUIT PVC PR 90 FF 75/50	U	4441C.3	21,45
238.0021.31	TE DROIT REDUIT PVC PR 90 FF 90/50	U	4441E.8	30,44
238.0021.35	TE DROIT REDUIT PVC PR 90 FF 90/63	U	4441F.6	30,50

RACCORD A COLLER PVC
 Joint plat pour collet - Strié

	DÉSIGNATION	UT	CODE	PPHT (€)
238.0001.89	JOINT PLAT POUR COLLET STRIE PVC PR 50	U	4442G.3	2,70
238.0002.26	JOINT PLAT POUR COLLET STRIE PVC PR 63	U	4442H.1	3,23
238.0003.22	JOINT PLAT POUR COLLET STRIE PVC PR 75	U	4442I.9	4,60
238.0003.54	JOINT PLAT POUR COLLET STRIE PVC PR 90	U	4442J.8	5,06
238.0004.46	JOINT PLAT POUR COLLET STRIE PVC PR 110	U	4442K.6	6,37
238.0004.83	JOINT PLAT POUR COLLET STRIE PVC PR 125	U	4442L.4	6,90
238.0005.29	JOINT PLAT POUR COLLET STRIE PVC PR 140	U	44438.0	7,55
238.0005.98	JOINT PLAT POUR COLLET STRIE PVC PR 160	U	4443C.1	8,54
238.0007.49	JOINT PLAT POUR COLLET STRIE PVC PR 200	U	4443D.9	10,70

PVC PRESSION

TUBES ET RACCORDS PVC PRESSION



RACCORD A COLLER PVC

Clapet anti-retour à boule - Sans ressort - Embout femelle à coller -PN 16 - Avec joint



	DÉSIGNATION	UT	CODE	PPHT (€)
264.0020.11	CLAPET ANTI-RETOUR A BOULE F.A COLL.40 VRS40	U	27453.0	33,51
264.0031.18	CLAPET ANTI-RETOUR A BOULE F.A COLL.50 VRS50	U	0786E.9	51,96
264.0036.74	CLAPET ANTI-RETOUR A BOULE F.A COLL.63 VRS63	U	0786F.7	66,80



MANCHON A COLLER / A VISSER PVC-U K62

FM - Taraudé - Avec bague métallique de renfort



	DÉSIGNATION	UT	CODE	PPHT (€)
238.0003.73	MANCHON TAR+ BAG.FM 20/25X3/4 K62 GIRPI BEG25	U	81866.6	5,33
238.0003.73	MANCHON TAR+ BAG.FM 25/32X1 K62 GIRPI BEG32	U	58331.0	6,21



UNION A VISSER / A COLLER PVC-U K62

FF - Mixte métal - Avec joint EPDM et écrou laiton



	DÉSIGNATION	UT	CODE	PPHT (€)
238.0009.01	UNION MIX MET.FF 25X3/4 K62 GIRPI UL25	U	21651.5	12,87



EQUIPEMENT COMPLEMENTAIRE

Bride ronde PN 16 en Polyamide fibre de verre



	DÉSIGNATION	UT	CODE	PPHT (€)	ECOPART (€)
251.0033.13	BRIDE POLYAMIDE FIB.VER. 63X50 PN16 BPA50	U	50448.0	33,16	0,03
251.0046.79	BRIDE POLYAMIDE FIB.VER. 75X60 PN16 BPA65	U	5044C.1	46,83	0,04
251.0051.66	BRIDE POLYAMIDE FIB.VER. 90X80 PN16 BPA80	U	5044D.9	51,70	0,04
251.0059.42	BRIDE POLYAMIDE FIB.VER. 110X100 PN16 BPA100	U	5044E.6	59,47	0,05



UNION A COLLER / A VISSER PVC-LAITON

FF - Taraudé



	DÉSIGNATION	UT	CODE	PPHT (€)
269.0014.93	UNION PVC/LAIT.TAR.A COLL. 25X3/4 RV0BMF25C	U	3529E.5	29,87

Le PPHT comprend l'ecopart (€)

PVC PRESSION

TUBES ET RACCORDS PVC PRESSION



UNION A COLLER / A VISSER PVC-LAITON

FF - Taraudé
- suite



	DÉSIGNATION	UT	CODE	PPHT (€)
269.0020.05	UNION PVC/LAIT.TAR.A COLL. 32X1 RV0BMF32D	U	3529F.3	40,09
269.0028.81	UNION PVC/LAIT.TAR.A COLL. 40X11/4 RV0BMF40E	U	3529G.1	57,61
269.0039.53	UNION PVC/LAIT.TAR.A COLL. 50X11/2 RV0BMF50F	U	3529H.9	79,07
269.0052.31	UNION PVC/LAIT.TAR.A COLL. 63X2 RV0BMF63G	U	3529I.7	104,62



UNION A COLLER / A VISSER PVC-LAITON

FM - Fileté



	DÉSIGNATION	UT	CODE	PPHT (€)
269.0018.64	UNION PVC/LAIT.FIL.A COLL. 25X3/4 RV0BMM25C	U	3531J.2	37,28
269.0025.05	UNION PVC/LAIT.FIL.A COLL. 32X1 RV0BMM32D	U	3531K.0	50,11
269.0035.75	UNION PVC/LAIT.FIL.A COLL. 40X11/4 RV0BMM40E	U	3531L.8	71,51
269.0064.97	UNION PVC/LAIT.FIL.A COLL. 63X2 RV0BMM63G	U	3532D.3	129,95
269.0049.19	UNION PVC/LAIT.FIL.A COLL. 50X11/2 RV0BMM50F	U	3532A.9	98,38



RACCORD A COLLER PVC

Clapet anti-retour



	DÉSIGNATION	UT	CODE	PPHT (€)	ECOPART (€)
267.0031.63	CLAPET ANTI-RETOUR PVC D032 CARF	U	66245.2	45,19	0,01
267.0042.55	CLAPET ANTI-RETOUR PVC D040 UCARH	U	03239.1	60,79	0,01
267.0054.26	CLAPET ANTI-RETOUR PVC D050 CARJ	U	66246.0	77,53	0,01
267.0067.46	CLAPET ANTI-RETOUR PVC D063 UCARL	U	43345.8	96,38	0,01

Pour plus d'infos,
consultez
le CAHIER TECHNIQUE
page 14

PVC PRESSION TECHNIQUE

TUBES ET RACCORDS PVC PRESSION EAU CHAUDE



TUBE HTA® POUR EAU CHAUDE

System'O® - Chanfreinés aux 2 extrémités



	DÉSIGNATION	UT	CODE	PPHT (€)	ECOPART (€)
260.0003.82	TUBE CPVC 3M 16X1.8 PN25 HTA GIRPI TUBHT163	M	38408.1	5,87	0,00
260.0004.86	TUBE CPVC 3M 20X2.3 PN25 HTA GIRPI TUBHT203	M	38422.2	7,48	0,00
260.0006.62	TUBE CPVC 3M 25X2.8 PN25 HTA GIRPI TUBHT253	M	38423.0	10,18	0,00
260.0006.86	TUBE CPVC 3M 32X2.4 PN16 HTA GIRPI THT3216	M	23443.5	10,55	0,00
260.0010.77	TUBE CPVC 3M 40X3.7 PN16 HTA GIRPI THT4016	M	23447.6	16,57	0,00
260.0016.61	TUBE CPVC 3M 50X3.7 PN16 HTA GIRPI THT5016	M	23448.4	25,56	0,00
260.0024.92	TUBE CPVC 4M 63X4.7 PN16 HTA GIRPI TUBHT63	M	38474.3	38,34	0,00
260.0045.73	TUBE CPVC 4M 75X5.5 PN16 HTA GIRPI TUBHT75	M	06726.4	70,35	0,00
260.0062.08	TUBE CPVC 4M 90X6.6 PN16 HTA GIRPI TUBHT90	M	10394.5	95,50	0,00



COUDE A COLLER HTA

FF - 45°



	DÉSIGNATION	UT	CODE	PPHT (€)	ECOPART (€)
260.0001.88	COUDE 45 SPLE FF 20 HTA GIRPI H8M20	U	38661.5	2,89	
260.0002.28	COUDE 45 SPLE FF 25 HTA GIRPI H8M25	U	38666.4	3,51	
260.0003.84	COUDE 45 SPLE FF 32 HTA GIRPI H8M32	U	38667.2	5,91	
260.0005.58	COUDE 45 SPLE FF 40 HTA GIRPI H8M40	U	38668.0	8,58	
260.0006.58	COUDE 45 SPLE FF 50 HTA GIRPI H8M50	U	38670.6	10,13	0,01
260.0011.29	COUDE 45 SPLE FF 63 HTA GIRPI H8M63	U	38671.4	17,38	0,01
260.0022.84	COUDE 45 SPLE FF 75 HTA GIRPI H8M75	U	005NV.2	35,15	0,01
260.0055.18	COUDE 45 SPLE FF 90 HTA GIRPI H8M90	U	2065D.0	84,91	0,02



COUDE A COLLER HTA

FF - 90°



	DÉSIGNATION	UT	CODE	PPHT (€)	ECOPART (€)
260.0001.53	COUDE 90 SPLE FF 16 HTA GIRPI H4M16	U	38652.4	2,35	
260.0001.65	COUDE 90 SPLE FF 20 HTA GIRPI H4M20	U	38653.2	2,54	
260.0002.33	COUDE 90 SPLE FF 25 HTA GIRPI H4M25	U	38654.0	3,59	
260.0003.17	COUDE 90 SPLE FF 32 HTA GIRPI H4M32	U	38655.7	4,88	
260.0005.12	COUDE 90 SPLE FF 40 HTA GIRPI H4M40	U	38656.5	7,88	
260.0008.40	COUDE 90 SPLE FF 50 HTA GIRPI H4M50	U	38657.3	12,93	0,01
260.0013.73	COUDE 90 SPLE FF 63 HTA GIRPI H4M63	U	38659.9	21,14	0,01
260.0020.37	COUDE 90 SPLE FF 75 HTA GIRPI H4M75	U	005NU.4	31,35	0,01
260.0054.91	COUDE 90 SPLE FF 90 HTA GIRPI H4M90	U	2065E.7	84,50	0,02

PVC PRESSION TECHNIQUE

TUBES ET RACCORDS PVC PRESSION EAU CHAUDE



MANCHON A COLLER HTA

FF



	DÉSIGNATION	UT	CODE	PPHT (€)	ECOPART (€)
260.0001.19	MANCHON FF 16 HTA GIRPI HMA16	U	38711.8	1,83	
260.0001.12	MANCHON FF 20 HTA GIRPI HMA20	U	38712.6	1,72	
260.0001.55	MANCHON FF 25 HTA GIRPI HMA25	U	38715.9	2,38	
260.0002.39	MANCHON FF 32 HTA GIRPI HMA32	U	38745.6	3,67	
260.0003.63	MANCHON FF 40 HTA GIRPI HMA40	U	38751.4	5,58	
260.0005.45	MANCHON FF 50 HTA GIRPI HMA50	U	38762.1	8,39	
260.0009.43	MANCHON FF 63 HTA GIRPI HMA63	U	38765.4	14,52	0,01
260.0022.84	MANCHON FF 75 HTA GIRPI HMA75	U	005NW.0	35,15	0,01



REDUCTION A COLLER HTA

MF - Double



	DÉSIGNATION	UT	CODE	PPHT (€)	ECOPART (€)
260.0003.35	REDUCTION DBLE MF 20 HTA GIRPI HRD32/20	U	38863.7	5,15	
260.0005.76	REDUCTION DBLE MF 20 HTA GIRPI HRD40/20	U	38864.5	8,86	
260.0004.91	REDUCTION DBLE MF 25 HTA GIRPI HRD40/25	U	38865.2	7,56	
260.0007.46	REDUCTION DBLE MF 25 HTA GIRPI HRD50/25	U	38866.0	11,47	
260.0006.36	REDUCTION DBLE MF 32 HTA GIRPI HRD50/32	U	38891.8	9,79	
260.0011.29	REDUCTION DBLE MF 20 HTA GIRPI HRD63/20	U	3629H.8	17,37	
260.0011.29	REDUCTION DBLE MF 25 HTA GIRPI HRD63/25	U	47831.3	17,37	
260.0011.29	REDUCTION DBLE MF 32 HTA GIRPI HRD63/32	U	38893.4	17,37	
260.0010.08	REDUCTION DBLE MF 40 HTA GIRPI HRD63/40	U	38902.3	15,52	0,01
260.0018.16	REDUCTION DBLE MF 32 HTA GIRPI HRD75/32	U	3205A.5	27,95	0,01
260.0018.16	REDUCTION DBLE MF 50 HTA GIRPI HRD75/50	U	005PB.5	27,95	0,01



REDUCTION A COLLER HTA

MF - Simple



	DÉSIGNATION	UT	CODE	PPHT (€)	ECOPART (€)
260.0001.19	REDUCTION SPLE MF 16 HTA GIRPI HRS20	U	38774.6	1,83	
260.0001.55	REDUCTION SPLE MF 20 HTA GIRPI HRS25	U	38775.3	2,38	
260.0002.28	REDUCTION SPLE MF 25 HTA GIRPI HRS32	U	38776.1	3,51	
260.0002.95	REDUCTION SPLE MF 32 HTA GIRPI HRS40	U	38783.7	4,54	
260.0004.45	REDUCTION SPLE MF 40 HTA GIRPI HRS50	U	38784.5	6,84	
260.0006.48	REDUCTION SPLE MF 50 HTA GIRPI HRS63	U	38808.2	9,97	
260.0009.37	REDUCTION SPLE MF 63 HTA GIRPI HRS75	U	005PD.1	14,41	
260.0013.70	REDUCTION SPLE MF 75 HTA GIRPI HRS90	U	2066E.6	21,09	0,01
260.0028.82	REDUCTION SPLE MF 90 HTA GIRPI HRS110	U	2066F.4	44,35	0,01

Le PPHT comprend l'ecopart (€)

PVC PRESSION TECHNIQUE

TUBES ET RACCORDS PVC PRESSION EAU CHAUDE

TE A COLLER HTA
 FFF - 90° - Egal

	DÉSIGNATION	UT	CODE	PPHT (€)	ECOPART (€)
260.0002.57	TE 90 EGAL FF 20 HTA GIRPI HTE20	U	38678.9	3,96	
260.0003.44	TE 90 EGAL FF 25 HTA GIRPI HTE25	U	38679.7	5,30	
260.0004.21	TE 90 EGAL FF 32 HTA GIRPI HTE32	U	38680.5	6,47	
260.0006.58	TE 90 EGAL FF 40 HTA GIRPI HTE40	U	38681.3	10,13	0,01
260.0011.58	TE 90 EGAL FF 50 HTA GIRPI HTE50	U	38682.1	17,82	0,01
260.0018.64	TE 90 EGAL FF 63 HTA GIRPI HTE63	U	39009.6	28,68	0,01
260.0029.98	TE 90 EGAL FF 75 HTA GIRPI HTE75	U	005NY.6	46,14	0,02
260.0074.97	TE 90 EGAL FF 90 HTA GIRPI HTE90	U	20665.6	115,37	0,03

TE A COLLER HTA
 FFF - 90° - Réduit

	DÉSIGNATION	UT	CODE	PPHT (€)	ECOPART (€)
260.0006.24	TE 90 RED.FF 32X25 HTA GIRPI HTR32/25	U	38697.9	9,60	
260.0009.61	TE 90 RED.FF 40X25 HTA GIRPI HTR40/25	U	38698.7	14,79	0,01
260.0009.61	TE 90 RED.FF 40X32 HTA GIRPI HTR40/32	U	38699.5	14,79	0,01
260.0016.93	TE 90 RED.FF 50X20 HTA GIRPI HTR50/20	U	14594.6	26,06	0,01
260.0016.93	TE 90 RED.FF 50X25 HTA GIRPI HTR50/25	U	14597.9	26,06	0,01
260.0016.93	TE 90 RED.FF 50X32 HTA GIRPI HTR50/32	U	38701.9	26,06	0,01
260.0016.93	TE 90 RED.FF 50X40 HTA GIRPI HTR50/40	U	38703.5	26,06	0,01
260.0024.85	TE 90 RED.FF 63X25 HTA GIRPI HTR63/25	U	38706.8	38,24	0,01
260.0024.85	TE 90 RED.FF 63X32 HTA GIRPI HTR63/32	U	38707.6	38,24	0,01
260.0024.85	TE 90 RED.FF 63X50 HTA GIRPI HTR63/50	U	36051.1	38,24	0,01

UNION A COLLER HTA
 FF

	DÉSIGNATION	UT	CODE	PPHT (€)	ECOPART (€)
260.0013.16	UNION 3 PCS FF CPVC 25 HTA GIRPI H3P25	U	39703.4	20,25	
260.0017.29	UNION 3 PCS FF CPVC 32 HTA GIRPI H3P32	U	39704.2	26,60	
260.0022.80	UNION 3 PCS FF CPVC 40 HTA GIRPI H3P40	U	39705.9	35,09	0,01
260.0032.15	UNION 3 PCS FF CPVC 50 HTA GIRPI H3P50	U	39706.7	49,47	0,01
260.0045.25	UNION 3 PCS FF CPVC 63 HTA GIRPI H3P63	U	50451.4	69,62	0,01

PVC PRESSION TECHNIQUE

TUBES ET RACCORDS PVC PRESSION EAU CHAUDE

RACCORD A COLLER HTA
 Collet strié - Femelle (sans joint)

	DÉSIGNATION	UT	CODE	PPHT (€)	ECOPART (€)
260.0005.51	COLLET STRIE SS JT F.32 HTA GIRPI HCS32	U	40717.1	8,48	
260.0008.05	COLLET STRIE SS JT F.40 HTA GIRPI HCS40	U	39044.3	12,38	
260.0012.23	COLLET STRIE SS JT F.50 HTA GIRPI HCS50	U	39047.6	18,82	
260.0018.60	COLLET STRIE SS JT F.63 HTA GIRPI HCS63	U	39055.9	28,62	
260.0021.12	COLLET STRIE SS JT F.75 HTA GIRPI HCS75	U	2066H.0	32,50	0,01
260.0043.17	COLLET STRIE SS JT F.90 HTA GIRPI HCS90	U	20661.8	66,43	0,01
260.0054.46	COLLET STRIE SS JT F.110 HTA GIRPI HCS110	U	18901.2	83,79	0,01

EMBOUT A VISSER / A COLLER HTA
 FM - Type HEAL - Fileté laiton

	DÉSIGNATION	UT	CODE	PPHT (€)
260.0008.05	EMBOUT FIL.LAIT.A 1/2 HTA GIRPI HEAL20	U	10200.4	12,39
260.0010.35	EMBOUT FIL.LAIT.A 3/4 HTA GIRPI HEAL25	U	10228.5	15,92
260.0018.34	EMBOUT FIL.LAIT.A 1" HTA GIRPI HEAL32	U	12471.9	28,21
260.0030.34	EMBOUT FIL.LAIT.A 1"1/4 HTA GIRPI HEAL40	U	4798A.6	46,67
260.0040.19	EMBOUT FIL.LAIT.A 1"1/2 HTA GIRPI HEAL50	U	56668.7	61,83
260.0053.15	EMBOUT FIL.LAIT.A 2" HTA GIRPI HEAL63	U	56735.4	81,77
260.0089.45	EMBOUT FIL.LAIT.A 2"1/2 HTA GIRPI HEAL75	U	3113K.6	137,61
260.0107.87	EMBOUT FIL.LAIT.A 3" HTA GIRPI HEAL90	U	3113L.4	165,95

EMBOUT A VISSER / A COLLER HTA
 FM - Type HEBL - Fileté laiton

	DÉSIGNATION	UT	CODE	PPHT (€)	ECOPART (€)
260.0008.89	EMBOUT FIL.LAIT.B 1/2 HTA GIRPI HEBL16	U	52541.0	13,68	
260.0011.00	EMBOUT FIL.LAIT.B 3/4 HTA GIRPI HEBL20	U	10248.3	16,93	
260.0015.68	EMBOUT FIL.LAIT.B 1" HTA GIRPI HEBL25	U	10263.2	24,13	
260.0045.18	EMBOUT FIL.LAIT.B 1"1/4 HTA GIRPI HEBL32	U	6364Y.8	45,18	
260.0059.64	EMBOUT FIL.LAIT.B 1"1/2 HTA GIRPI HEBL40	U	6365E.5	59,65	0,01
260.0080.87	EMBOUT FIL.LAIT.B 2" HTA GIRPI HEBL50	U	63651.7	80,87	

MANCHON A COLLER / A VISSER HTA FER/PVC
 FM - Taraudage laiton

	DÉSIGNATION	UT	CODE	PPHT (€)
260.0007.62	MANCHON TAR.LAIT.FM 1/2 HTA GIRPI HMML20	U	10286.3	11,73
260.0009.31	MANCHON TAR.LAIT.FM 3/4 HTA GIRPI HMML25	U	10313.5	14,32

Le PPHT comprend l'ecopart (€)

PVC PRESSION TECHNIQUE

TUBES ET RACCORDS PVC PRESSION EAU CHAUDE



MANCHON A COLLER / A VISSER HTA FER/PVC
FM - Taraudage laiton
- suite

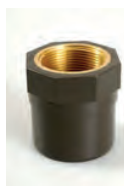

	DÉSIGNATION	UT	CODE	PPHT (€)
260.0017.80	MANCHON TAR.LAIT.FM 1" HTA GIRPI HMML32	U	10326.7	27,39
260.0032.87	MANCHON TAR.LAIT.FM 1"1/4 HTA GIRPI HMML40	U	94142.7	50,57
260.0038.91	MANCHON TAR.LAIT.FM 1"1/2 HTA GIRPI HMML50	U	92233.6	59,86
260.0051.34	MANCHON TAR.LAIT.FM 2" HTA GIRPI HMML63	U	92242.7	78,98
260.0076.18	MANCHON TAR.LAIT.FM 2"1/2 HTA GIRPI HMML75	U	31140.7	117,20
260.0088.26	MANCHON TAR.LAIT.FM 3" HTA GIRPI HMML90	U	31145.6	135,79



UNION A COLLER / A VISSER HTA FER/PVC
FF - 3 pièces - Taraudé laiton



	DÉSIGNATION	UT	CODE	PPHT (€)
260.0013.62	UNION 3 PCS MIXT.CPVC 20 HTA GIRPI H3G/L20	U	40548.0	20,96
260.0019.77	UNION 3 PCS MIXT.CPVC 25 HTA GIRPI H3G/L25	U	40551.4	30,41
260.0026.83	UNION 3 PCS MIXT.CPVC 32 HTA GIRPI H3G/L32	U	40555.5	41,27
260.0044.66	UNION 3 PCS MIXT.CPVC 40 HTA GIRPI H3G/L40	U	40559.7	68,70
260.0054.59	UNION 3 PCS MIXT.CPVC 50 HTA GIRPI H3G/L50	U	40560.5	83,99
260.0091.36	UNION 3 PCS MIXT.CPVC 63 HTA GIRPI H3G/L63	U	52572.5	140,56



UNION A COLLER / A VISSER HTA FER/PVC
MF - 3 pièces - Filetée laiton



	DÉSIGNATION	UT	CODE	PPHT (€)	ECOPART (€)
260.0014.57	UNION 3 PCS FIL.MF CPVC 20 HTA GIRPI H3F/L20	U	39756.2	22,42	
260.0021.85	UNION 3 PCS FIL.MF CPVC 25 HTA GIRPI H3F/L25	U	39760.4	33,62	
260.0029.92	UNION 3 PCS FIL.MF CPVC 32 HTA GIRPI H3F/L32	U	39761.2	46,03	
260.0048.83	UNION 3 PCS FIL.MF CPVC 40 HTA GIRPI H3F/L40	U	39765.3	75,13	
260.0059.52	UNION 3 PCS FIL.MF CPVC 50 HTA GIRPI H3F/L50	U	39766.1	91,58	0,01
260.0094.67	UNION 3 PCS FIL.MF CPVC 63 HTA GIRPI H3F/L63	U	39769.5	145,65	



TE A COLLER / A VISSER HTA FER/PVC
FFF - 90° - Taraudage laiton



	DÉSIGNATION	UT	CODE	PPHT (€)
260.0015.60	TE INSERT LAIT.TAR.32X3/4 HTA GIRPI HTGRL3234	U	3633A.7	24,00
260.0032.37	TE INSERT LAIT.TAR.40-1/2 HTA GIRPI HTGRL4012	U	07310.4	32,37
260.0018.79	TE INSERT LAIT.TAR.40X3/4 HTA GIRPI HTGRL4034	U	3633D.1	28,91
260.0037.76	TE INSERT LAIT.TAR.50 1/2 HTA GIRPI HTGRL5012	U	35420.7	37,76

PVC PRESSION TECHNIQUE

TUBES ET RACCORDS PVC PRESSION EAU CHAUDE



TE A COLLER / A VISSER HTA FER/PVC
FFF - 90° - Taraudage laiton
- suite



	DÉSIGNATION	UT	CODE	PPHT (€)
260.0021.92	TE INSERT LAIT.TAR.50X3/4 HTA GIRPI HTGRL5034	U	3633E.8	33,73
260.0028.21	TE INSERT LAIT.TAR.63X3/4 HTA GIRPI HTGRL6334	U	3633F.6	43,40



RACCORD A VISSER/PVC A COLLER HTA FER/ PVC

Douille de raccordement - Mâle taraudage à visser - Avec joint, bague et écrou fou en laiton



	DÉSIGNATION	UT	CODE	PPHT (€)
260.0006.85	DOUILLE RACC.MF 20X3/4 HTA GIRPI HDR20	U	38971.8	10,54
260.0009.69	DOUILLE RACC.MF 25X1" HTA GIRPI HDR25	U	38981.7	14,91
260.0013.60	DOUILLE RACC.MF 32X1"1/4 HTA GIRPI HDR32	U	38985.8	20,92
260.0017.51	DOUILLE RACC.MF 40X1"1/2 HTA GIRPI HDR40	U	38991.6	26,94
260.0030.15	DOUILLE RACC.MF 50X2" HTA GIRPI HDR50	U	39000.5	46,39

TUBES ET RACCORDS PVC PRESSION EAU GLACEE



MANCHON A COLLER / A VISSER KRYOCLIM®
Manchon récupération des condensats



	DÉSIGNATION	UT	CODE	PPHT (€)
000.0003.92	MANCHON RECUP.CONDENSAT D32X16 ACP32/16	U	274NS.1	3,92
000.0004.14	MANCHON RECUP.CONDENSAT D40X16 ACP40/16	U	274NT.9	4,14

Pour plus d'infos,
consultez
le CAHIER TECHNIQUE
page 14

POLYETHYLENE

TUBES POLYETHYLENE



TUBE POLYETHYLENE HAUTE DENSITE BANDE BLEUE

Eau potable - Couronne



	DÉSIGNATION	UT	CODE	PPHT (€)
271.0052.47	TUBE POLYETH.B.BLEUES HD 16B 25X3.0 COUR.25M	U	33036.5	104,94
271.0068.79	TUBE POLYETH.B.BLEUES HD 16B 32X3.6 COUR. 25M	U	73461.6	137,58
271.0077.24	TUBE POLYETH.B.BLEU.PE100 16B 20X3 COUR.50M	U	34152.9	154,48
000.0099.93	TUBE POLYETH.B.BLEU.PE100 16B 25X3 COUR.50M	U	33038.1	199,86
271.0131.03	TUBE POLYETH.B.BLEU.PE100 16B 32X3 COUR.50M	U	34155.2	262,05
271.0226.21	TUBE POLYETH.B.BLEU.PE100 16B 40X3.7 COUR.50M	U	34157.8	452,42
271.0351.63	TUBE POLYETH.B.BLEU.PE100 16B 50X4.6 COUR.50M	U	34163.6	703,27
271.0262.05	TUBE POLYETH.B.BLEU.PE100 16B 32X3 COUR.100M	U	34156.0	524,09
271.0452.42	TUBE POLYETH.B.BLEU.PE100 16B40X3.7 COUR.100M	U	72900.4	904,84
271.0199.87	TUBE POLYETH.B.BLEU.PE100 16B 25X3 COUR.100M	U	34153.7	399,75
271.0465.17	TUBE POLYETH.B.BLEU.PE100 16B 63X5.8 COUR.50M	U	3290P.3	930,33

RACCORDS LAITON POUR PE



RACCORD DROIT

Raccord droit pour tuyau PE mâle



	DÉSIGNATION	UT	CODE	PPHT (€)
375.0007.27	RACCORD MALE P.TUYAU PE 1/4" DN8 D70001B	U	5802V.6	7,27



COUDE

Laiton 90° égal - Type 120



	DÉSIGNATION	UT	CODE	PPHT (€)	ECOPART (€)
373.0025.41	COUDE EGAL 90° TYPE 120 ISIFLO 20X20 573200	U	09941.6	33,89	0,01
373.0021.87	COUDE EGAL 90° TYPE 120 ISIFLO 25X25 573250	U	09524.0	29,17	0,01
373.0031.94	COUDE EGAL 90° TYPE 120 ISIFLO 32X32 573320	U	09525.7	42,59	0,01
373.0050.68	COUDE EGAL 90° TYPE 120 ISIFLO 40X40 573400	U	09942.4	67,59	0,01
373.0097.82	COUDE EGAL 90° TYPE 120 ISIFLO 50X50 573500	U	09943.2	130,43	0,01
373.0141.32	COUDE EGAL 90° TYPE 120 ISIFLO 63X63 573630	U	09944.0	188,44	0,01



COUDE

Laiton 90° - Mâle à visser / extérieur PE (90°) type 121



	DÉSIGNATION	UT	CODE	PPHT (€)	ECOPART (€)
373.0020.72	COUDE MALE TYPE 121 ISIFLO 25-03/4 553254	U	09662.8	27,63	0,01
373.0029.94	COUDE MALE TYPE 121 ISIFLO 32-01" 553325	U	09663.6	39,93	0,01
373.0050.36	COUDE MALE TYPE 121 ISIFLO 40-11/4 553406	U	09664.4	67,16	0,01
373.0067.82	COUDE MALE TYPE 121 ISIFLO 50-11/2 553507	U	09946.5	90,43	0,01

Le PPHT comprend l'ecopart (€)

POLYETHYLENE

RACCORDS LAITON POUR PE



COUDE

Laiton 90° - Mâle à visser / extérieur PE (90°) type 121 - suite



	DÉSIGNATION	UT	CODE	PPHT (€)	ECOPART (€)
373.0092.44	COUDE MALE TYPE 121 ISIFLO 63-02" 553638	U	10047.9	123,26	0,01



COUDE

Laiton 90° - Femelle à visser / extérieur PE (90°) type 122



	DÉSIGNATION	UT	CODE	PPHT (€)	ECOPART (€)
373.0016.46	COUDE FEMELLE TYPE 122 ISIFLO 20-1/2 563203	U	09968.9	21,95	
373.0016.71	COUDE FEMELLE TYPE 122 ISIFLO 25-3/4 563254	U	09969.7	22,29	0,01
373.0022.88	COUDE FEMELLE TYPE 122 ISIFLO 32-1 563325	U	09670.1	30,51	0,01
373.0035.30	COUDE FEMELLE TYPE 122 ISIFLO 40-11/4 563406	U	09673.5	47,08	0,01
373.0048.40	COUDE FEMELLE TYPE 122 ISIFLO 50-11/2 563507	U	09674.3	64,54	0,01
373.0089.96	COUDE FEMELLE TYPE 122 ISIFLO 63-2 563638	U	10072.7	119,95	0,01



COUDE

90° écrou prisonnier - Type 119



	DÉSIGNATION	UT	CODE	PPHT (€)	ECOPART (€)
373.0031.82	COUDE A ECROU ISIFLO 25-3/4 TYPE 119 583254	U	31524.2	42,43	0,01
373.0052.00	COUDE A ECROU ISIFLO 32-1" TYPE 119 583325	U	31527.5	69,35	0,01



TE

Té Egal T125 - Egal



	DÉSIGNATION	UT	CODE	PPHT (€)	ECOPART (€)
373.0023.72	TE EGAL TYPE 125 ISIFLO 20X20X20 574200	U	62879.2	31,64	0,01
373.0021.60	TE EGAL TYPE 125 ISIFLO 25X25X25 574250	U	62880.0	28,81	0,01
373.0033.97	TE EGAL TYPE 125 ISIFLO 32X32X32 574320	U	62883.4	45,30	0,01
373.0045.30	TE EGAL TYPE 125 ISIFLO 40X40X40 574400	U	62881.8	60,41	0,01
373.0094.00	TE EGAL TYPE 125 ISIFLO 50X50X50 574500	U	62882.6	125,34	0,01



TE

Laiton fileté - Mâle à visser / extérieur PE type 131



	DÉSIGNATION	UT	CODE	PPHT (€)	ECOPART (€)
373.0019.72	TE FILETE MALE 20-1/2 TYPE 131 554203	U	06494.9	26,31	0,01
373.0022.29	TE FILETE MALE 25-3/4 TYPE 131 554254	U	06495.6	29,73	0,01
373.0034.28	TE FILETE MALE 32-1" TYPE 131 554325	U	06496.4	45,71	0,01

POLYETHYLENE

RACCORDS LAITON POUR PE



TE

Laiton fileté - Mâle à visser / extérieur PE type 131 - suite



	DÉSIGNATION	UT	CODE	PPHT (€)	ECOPART (€)
373.0051.82	TE FILETE MALE 40-11/4 TYPE 131 554406	U	09667.7	69,10	0,01
373.0074.24	TE FILETE MALE 50-11/2 TYPE 131 554507	U	09716.2	98,99	0,01



TE

Laiton fileté - Femelle à visser / extérieur PE type 132



	DÉSIGNATION	UT	CODE	PPHT (€)	ECOPART (€)
373.0024.10	TE FILETE FEM.TYPE 132 ISIFLO 20-1/2 564203	U	74129.8	32,14	0,01
373.0026.29	TE FILETE FEM.TYPE 132 ISIFLO 25-3/4 564254	U	55140.8	35,06	0,01
373.0032.87	TE FILETE FEM.TYPE 132 ISIFLO 32-1" 564325	U	41679.2	43,84	0,01
373.0052.61	TE FILETE FEM.TYPE 132 ISIFLO 40-11/4 564406	U	56632.3	70,16	0,01
373.0105.27	TE FILETE FEM.TYPE 132 ISIFLO 50-11/2 564507	U	18913.4	140,37	0,01
373.0192.51	TE FILETE FEM.TYPE 132 ISIFLO 63-2" 564638	U	74624.8	256,69	0,01



MANCHON

Union double réparation - Type 101



	DÉSIGNATION	UT	CODE	PPHT (€)
373.0027.78	MANCHON REPARAT.TYPE 101 ISIFLO 25X25 171250	U	79843.9	37,04
373.0037.53	MANCHON REPARAT.TYPE 101 ISIFLO 32X32 171320	U	79842.1	50,04
373.0064.86	MANCHON REPARAT.TYPE 101 ISIFLO 40X40 171400	U	22021.0	86,48
373.0090.17	MANCHON REPARAT.TYPE 101 ISIFLO 50X50 171500	U	22022.8	120,23
373.0134.33	MANCHON REPARAT.TYPE 101 ISIFLO 63X63 171630	U	22023.6	179,11



RACCORD UNION

Raccord droit laiton Femelle à visser / extérieur PE - Type 116



	DÉSIGNATION	UT	CODE	PPHT (€)	ECOPART (€)
373.0008.75	RACCORD FEM.TYPE 116 ISIFLO 20-1/2 561203	U	62873.5	11,67	
373.0008.92	RACCORD FEM.TYPE 116 ISIFLO 25-3/4 561254	U	71318.0	11,90	
373.0013.01	RACCORD FEM.TYPE 116 ISIFLO 32-1" 561325	U	62875.0	17,36	0,01
373.0020.98	RACCORD FEM.TYPE 116 ISIFLO 40-11/4 561406	U	62876.8	27,98	0,01
373.0031.94	RACCORD FEM.TYPE 116 ISIFLO 50-1" 561507	U	62877.6	42,59	0,01
373.0052.20	RACCORD FEM.TYPE 116 ISIFLO 63-2" 561638	U	62878.4	69,61	0,01

POLYETHYLENE

RACCORDS LAITON POUR PE



RACCORD UNION

Raccord droit laiton mâle à visser / extérieur PE - Type 110



	DÉSIGNATION	UT	CODE	PPHT (€)	ECOPART (€)
373.0008.20	RACCORD MALE TYPE 110 ISIFLO 20-1/2 551203	U	62867.7	10,94	
373.0009.26	RACCORD MALE TYPE 110 ISIFLO 25-3/4 551254	U	62868.5	12,35	
373.0014.43	RACCORD MALE TYPE 110 ISIFLO 32-1 551325	U	62869.3	19,25	0,01
373.0022.59	RACCORD MALE TYPE 110 ISIFLO 40-11/4 551406	U	62870.1	30,13	0,01
373.0032.89	RACCORD MALE TYPE 110 ISIFLO 50-11/2 551507	U	62871.9	43,86	0,01
373.0058.73	RACCORD MALE TYPE 110 ISIFLO 63-2 551638	U	62872.7	78,32	0,01



RACCORD UNION

Raccord droit Mâle-Femelle - Type 110-116



	DÉSIGNATION	UT	CODE	PPHT (€)	ECOPART (€)
373.0217.51	RACCORD ISIFLO FEM 75-66/76 551769	U	1699X.7	362,52	0,01



RACCORD UNION

Raccord droit laiton PE à visser réduit - Mâle à visser / extérieur PE type 112



	DÉSIGNATION	UT	CODE	PPHT (€)	ECOPART (€)
373.0015.95	RACCORD MALE RED.TYPE112 ISIFLO32-3/4 551324	U	09661.0	21,28	0,01



RACCORD UNION

Raccord droit laiton PE à visser réduit - Femelle à visser / extérieur PE type 116



	DÉSIGNATION	UT	CODE	PPHT (€)	ECOPART (€)
373.0016.32	RACCORD FEMELLE TYPE116 ISIFLO 32-3/4 561324	U	67706.2	21,77	0,01



RACCORD UNION

Raccord droit laiton PE à visser augmenté - Mâle à visser / extérieur PE type 105



	DÉSIGNATION	UT	CODE	PPHT (€)	ECOPART (€)
373.0011.26	RACCORD MALE TYPE 105 ISIFLO 25 1" 551255	U	09719.6	15,02	0,01

Le PPHT comprend l'ecopart (€)

POLYETHYLENE

RACCORDS LAITON POUR PE

isiflo
RACCORD UNION

Raccord droit écrou prisonnier - Type 109



	DÉSIGNATION	UT	CODE	PPHT (€)	ECOPART (€)
373.0022.20	RACCORD FEM+EC.TYPE 109 ISIFLO 25-3/4 581254	U	31520.0	29,61	0,01
373.0031.35	RACCORD FEM+EC.TYPE 109 ISIFLO 32-3/4 581324	U	26430.9	41,81	0,01
373.0034.28	RACCORD FEM+EC.TYPE 109 ISIFLO 32-1" 581325	U	31522.6	45,71	0,01

isiflo
RACCORD UNION

Union double - Union double iso PE/FER - Type 100



	DÉSIGNATION	UT	CODE	PPHT (€)	ECOPART (€)
373.0014.22	MANCHON TYPE 100 ISIFLO 20X20 571200	U	62859.4	18,97	0,01
373.0013.76	MANCHON TYPE 100 ISIFLO 25X25 571250	U	62860.2	18,36	0,01
373.0021.98	MANCHON TYPE 100 ISIFLO 32X32 571320	U	62861.0	29,31	0,01
373.0029.55	MANCHON TYPE 100 ISIFLO 40X40 571400	U	62862.8	39,41	0,01
373.0048.82	MANCHON TYPE 100 ISIFLO 50X50 571500	U	62863.6	65,11	0,01
373.0095.94	MANCHON TYPE 100 ISIFLO 63X63 571630	U	62864.4	127,93	0,01

isiflo
RACCORD UNION

Applique murale laiton - Femelle à visser / extérieur PE type 150



	DÉSIGNATION	UT	CODE	PPHT (€)	ECOPART (€)
373.0017.55	APPLIQUE MURALE 20-1/2 TYPE 150 565203	U	06498.0	23,41	0,01
373.0021.92	APPLIQUE MURALE 25-1/2 TYPE 150 565253	U	79245.7	29,24	0,01
373.0020.87	APPLIQUE MURALE 25-3/4 TYPE 150 565254	U	06499.8	27,84	0,01

isiflo
RACCORD UNION

Union double réduit - Type 102



	DÉSIGNATION	UT	CODE	PPHT (€)	ECOPART (€)
373.0035.30	MANCHON REDUIT TYPE 102 ISIFLO 32X25 571322	U	44641.9	47,08	0,01

sferaco
ROBINETTERIE, COMPTEURS & RACCORDES

RACCORD DECA POUR TUBE PE
Raccord droit - 860 - Femelle



	DÉSIGNATION	UT	CODE	PPHT (€)	ECOPART (€)
373.0136.04	RACCORD LAIT.P.PE DROIT FEM. 2"1/2 75 860075	U	91543.9	209,33	0,03
373.0195.55	RACCORD LAIT.P.PE DROIT FEM. 3" 90 860090	U	91546.2	300,90	0,05

Le PPHT comprend l'ecopart (€)

ACIER

TUBES ACIER GALVA



TUBE S195 T1 ACIER SOUDE SANS FILETAGE

Norme W-EN10255 - Galva



	DÉSIGNATION	UT	CODE	PPHT (€)
041.0005.64	TUBE SOUD.S195T T1 GBL W-EN10255 21.3X2.30	M	00578.5	10,25
041.0006.22	TUBE SOUD.S195T T1 GBL W-EN10255 26.9X2.30	M	00579.3	11,30
041.0008.50	TUBE SOUD.S195T T1 GBL W-EN10255 33.7X2.90	M	00580.1	15,46
041.0010.16	TUBE SOUD.S195T T1 GBL W-EN10255 42.4X2.90	M	00581.9	18,48
041.0014.21	TUBE SOUD.S195T T1 GBL W-EN10255 48.3X2.90	M	00582.7	25,83
041.0015.38	TUBE SOUD.S195T T1 GBL W-EN10255 60.3X3.20	M	00583.5	27,97



TUBE S195 T1 ACIER SOUDE FILETE MANCHONNE

Norme W-EN10255 - Galva



	DÉSIGNATION	UT	CODE	PPHT (€)
041.0006.10	TUBE SOUD.S195T T1 GFM W-EN10255 21.3X2.30	M	00537.1	11,09
041.0006.42	TUBE SOUD.S195T T1 GFM W-EN10255 26.9X2.30	M	00538.9	11,68
041.0009.12	TUBE SOUD.S195T T1 GFM W-EN10255 33.7X2.90	M	00539.7	16,59
041.0011.74	TUBE SOUD.S195T T1 GFM W-EN10255 42.4X2.90	M	00540.5	21,34
041.0014.44	TUBE SOUD.S195T T1 GFM W-EN10255 48.3X2.90	M	00541.3	26,25
041.0018.34	TUBE SOUD.S195T T1 GFM W-EN10255 60.3X3.20	M	00542.1	33,35



TUBE S195 T2 ACIER SOUDE SANS FILETAGE

Norme W-EN10255 - Galva



	DÉSIGNATION	UT	CODE	PPHT (€)
041.0020.63	TUBE SOUD.S195T T2 GBL W-EN10255 76.1X3.20	M	00585.0	37,51



TUBE S195 T2 ACIER SOUDE FILETE MANCHONNE

Norme W-EN10255 - Galva



	DÉSIGNATION	UT	CODE	PPHT (€)
041.0025.22	TUBE SOUD.S195T T2 GFM W-EN10255 76.1X3.20	M	00544.7	45,86

ACIER

TUBES ACIER GALVA

**TUBE S195 T3 ACIER SANS SOUDURE,
SANS FILETAGE**

Norme S-EN10255 - Galva



	DÉSIGNATION	UT	CODE	PPHT (€)
061.0022.45	TUBE SS S195T GBL S-EN10255 48.3X3.20	M	00669.2	40,82
061.0020.14	TUBE SS S195T GBL S-EN10255 60.3X3.60	M	00670.0	36,62
061.0030.95	TUBE SS S195T GBL S-EN10255 76.1X3.60	M	00672.6	56,28
061.0042.88	TUBE SS S195T GBL S-EN10255 88.9X4.00	M	00673.4	77,96

**TUBE S195 T3 ACIER SANS SOUDURE,
FILETE MANCHONNE**

Norme S-EN10255 - Galva



	DÉSIGNATION	UT	CODE	PPHT (€)
061.0032.93	TUBE SS S195T GFM S-EN10255 76.1X3.60	M	00659.3	59,88

RACCORDS ACIER GALVA A SOUDER

COURBE

3D - 90° - Sans soudure - EN10253-1 - Galva



	DÉSIGNATION	UT	CODE	PPHT (€)
345.0003.51	COURBE A SOUD. GALVA NF EN10253-1 3D 90 26,9	U	58398.9	5,85
345.0005.73	COURBE A SOUD. GALVA NF EN10253-1 3D 90 48,3	U	58401.1	9,55
345.0009.30	COURBE A SOUD. GALVA NF EN10253-1 3D 90 60,3	U	58402.9	15,50
345.0014.04	COURBE A SOUD. GALVA NF EN10253-1 3D 90 76,1	U	58404.5	23,40
345.0020.82	COURBE A SOUD. GALVA NFA 49186 3D 90 88,9	U	58405.2	34,70

FOND

Bombé à souder - EN10253-1 - Galva



	DÉSIGNATION	UT	CODE	PPHT (€)
345.0001.89	FOND BOMBE GALVA NF EN10253-1 48.3X2.6	U	40108.3	3,15
345.0002.67	FOND BOMBE GALVA NF EN10253-1 60.3X2.9	U	20771.2	4,45
345.0003.72	FOND BOMBE GALVA NF EN10253-1 76.1X2.9	U	20776.1	6,20

ACIER

RACCORDS ACIER GALVA A VISSER

MANCHON

Filetage cylindrique - 270 - EN10241 - Galva



	DÉSIGNATION	UT	CODE	PPHT (€)
345.0001.08	MANCHON FER GALVA 15X21	U	21405.6	1,80
345.0001.47	MANCHON FER GALVA 20X27	U	21407.2	2,45
345.0002.37	MANCHON FER GALVA 26X34	U	21408.0	3,95
345.0003.36	MANCHON FER GALVA 33X42	U	21409.8	5,60
345.0003.90	MANCHON FER GALVA 40X49	U	21410.6	6,50
345.0005.49	MANCHON FER GALVA 50X60	U	21411.4	9,15
345.0008.82	MANCHON FER GALVA 66X76	U	21466.0	14,70

MAMELON

Filetage conique - 530 - EN10241 - Galva



	DÉSIGNATION	UT	CODE	PPHT (€)
345.0002.22	MAMELON 530 GALVA 26X34 50	U	68199.9	3,70
345.0001.98	MAMELON 530 GALVA 15X21 100	U	51897.7	3,30
345.0002.70	MAMELON 530 GALVA 20X27 100	U	21335.5	4,50
345.0003.51	MAMELON 530 GALVA 26X34 100	U	51899.3	5,85
345.0004.68	MAMELON 530 GALVA 33X42 100	U	52771.3	7,80
345.0005.37	MAMELON 530 GALVA 40X49 100	U	51902.5	8,95
345.0007.35	MAMELON 530 GALVA 50X60 100	U	51903.3	12,25
345.0002.88	MAMELON 530 GALVA 15X21 150	U	44950.4	4,80
345.0003.45	MAMELON 530 GALVA 20X27 150	U	52774.7	5,75
345.0004.68	MAMELON 530 GALVA 26X34 150	U	52775.4	7,80
345.0006.06	MAMELON 530 GALVA 33X42 150	U	52776.2	10,10
345.0007.05	MAMELON 530 GALVA 40X49 150	U	52777.0	11,75
345.0010.47	MAMELON 530 GALVA 50X60 150	U	52784.6	17,45
345.0015.09	MAMELON 530 GALVA 66X76 150	U	52785.3	25,15
345.0018.24	MAMELON 530 GALVA 80X90 150	U	52786.1	30,40
345.0003.72	MAMELON 530 GALVA 15X21 200	U	51898.5	6,20
345.0004.41	MAMELON 530 GALVA 20X27 200	U	52788.7	7,35
345.0005.97	MAMELON 530 GALVA 26X34 200	U	51900.9	9,95
345.0007.98	MAMELON 530 GALVA 33X42 200	U	51901.7	13,30
345.0009.36	MAMELON 530 GALVA 40X49 200	U	52787.9	15,60
345.0014.04	MAMELON 530 GALVA 50X60 200	U	51904.1	23,40
345.0018.57	MAMELON 530 GALVA 66X76 200	U	09521.6	30,95
345.0022.71	MAMELON 530 GALVA 80X90 200	U	62345.4	37,85
345.0012.72	MAMELON 530 GALVA 40X49 300	U	18266.7	21,20
345.0019.26	MAMELON 530 GALVA 50X60 300	U	18267.5	32,10
345.0005.97	MAMELON 530 GALVA 20X27 300	U	69100.6	9,95
345.0008.25	MAMELON 530 GALVA 26X34 300	U	69104.8	13,75
345.0010.89	MAMELON 530 GALVA 33X42 300	U	69111.3	18,15
345.0004.98	MAMELON 530 GALVA 15X21 300	U	69095.8	8,30
345.0007.86	MAMELON 530 GALVA 20X27 400	U	71282.8	13,10
345.0019.95	MAMELON 530 GALVA 1M 20X27	U	14717.3	33,25
345.0027.78	MAMELON 530 GALVA 1M 26X34	U	14718.1	46,30
345.0016.50	MAMELON 530 GALVA 1M 15X21	U	14716.5	27,50
345.0016.50	MAMELON 530 GALVA 1M 12X17	U	14721.5	27,50
345.0037.14	MAMELON 530 GALVA 1M 33X42	U	14719.9	61,90

ACIER

RACCORDS ACIER GALVA A VISSER



MAMELON
Filetage conique - 530 - EN10241 - Galva
- suite



	DÉSIGNATION	UT	CODE	PPHT (€)
345.0044.04	MAMELON 530 GALVA 1M 40X49	U	27263.3	73,40



BRIDE TARAUEE
Plate - PN16 - Galva



	DÉSIGNATION	UT	CODE	PPHT (€)
345.0047.34	BRIDE PLATE TARAUEE PN16 GALVA DN50 TUB.60.3	U	1288F.8	78,90
345.0054.25	BRIDE PLATE TARAUEE PN16 GALVA DN65 TUB.76.1	U	1288G.6	90,42
345.0095.15	BRIDE PLATE TARAUEE PN16 GALVA DN80 TUB.88.9	U	1288H.4	158,58

RACCORDS ACIER GALVA A SERTIR

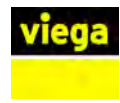

COUDE MEGAPRESS AVEC SC-CONTUR
90° - FF - 4216 - Joint EPDM



	DÉSIGNATION	UT	CODE	PPHT (€)
000.0009.46	COUDE 90 AV.SC AC.GALVA 1/2 VIEGA 694517	U	5738D.0	15,77
000.0010.61	COUDE 90 AV.SC AC.GALVA 3/4 VIEGA 694524	U	5738E.7	17,68
000.0012.80	COUDE 90 AV.SC AC.GALVA 1 VIEGA 694531	U	5738I.9	21,34
000.0019.21	COUDE 90 AV.SC AC.GALVA 1"1/4 VIEGA 694548	U	2840K.8	32,01
000.0021.71	COUDE 90 AV.SC AC.GALVA 1"1/2 VIEGA 694555	U	5738T.0	36,18
000.0036.49	COUDE 90 AV.SC AC.GALVA 2" VIEGA 694562	U	2839Q.1	60,82



MANCHON MEGAPRESS AVEC SC-CONTUR
FF - 4215 - Joint EPDM



	DÉSIGNATION	UT	CODE	PPHT (€)
000.0009.65	MANCHON AC.GALVA FF 1/2 VIEGA 694753	U	5771R.2	16,09
000.0010.36	MANCHON AC.GALVA FF 3/4 VIEGA 694760	U	5773F.1	17,27
000.0016.82	MANCHON AC.GALVA FF 1"1/2 VIEGA 694791	U	5773V.1	28,04
000.0019.28	MANCHON AC.GALVA FF 2" VIEGA 694807	U	2839I.4	32,14

ACIER

RACCORDS ACIER GALVA A SERTIR



PIECE DE TRANSITION AVEC SC-CONTUR
FM - 4211



	DÉSIGNATION	UT	CODE	PPHT (€)
000.0009.89	PIECE TRANS.AC.GALVA 1/2X1/2 VIEGA 695279	U	21821.4	16,48
000.0010.96	PIECE TRANS.AC.GALVA 3/4-3/4 VIEGA 695286	U	4206P.4	18,27
000.0013.28	PIECE TRANS.AC.GALVA 1"X1" VIEGA 695293	U	4206R.0	22,14
000.0016.22	PIECE TRANS.AC.GALVA 1"1/4X1"1/4 VIEGA 695309	U	4206T.6	27,03
000.0019.02	PIECE TRANS.AC.GALVA 1"1/2X1"1/2 VIEGA 695316	U	4206U.3	31,70
000.0025.77	PIECE TRANS.AC.GALVA 2"X2" VIEGA 695323	U	4207A.1	42,95



PIECE DE TRANSITION AVEC SC-CONTUR
Mâle - 4215.1



	DÉSIGNATION	UT	CODE	PPHT (€)
000.0011.99	REDUCTION AC.GALV.M. 3/4X1/2 VIEGA 695392	U	5777M.4	19,98
000.0014.80	REDUCTION AC.GALV.M. 1"X3/4 VIEGA 695415	U	57831.0	24,67
000.0011.60	REDUCTION AC.GALV.M. 1"1/4X1" VIEGA 695446	U	5785A.2	19,33

RACCORDS FONTE MALLEABLE GALVA



COUDE
FF - 90° - 90 - EN10242 - Galva



	DÉSIGNATION	UT	CODE	PPHT (€)
340.0002.91	COUDE EGAL FF GALVA 90 12X17	U	03685.5	4,85
340.0002.00	COUDE EGAL FF GALVA 90 15X21	U	03686.3	3,33
340.0003.14	COUDE EGAL FF GALVA 90 20X27	U	03687.1	5,23
340.0004.62	COUDE EGAL FF GALVA 90 26X34	U	03688.9	7,70
340.0008.81	COUDE EGAL FF GALVA 90 33X42	U	03689.7	14,68
340.0014.14	COUDE EGAL FF GALVA 90 40X49	U	03690.5	23,56
340.0016.70	COUDE EGAL FF GALVA 90 50X60	U	03691.3	27,84
340.0048.68	COUDE EGAL FF GALVA 90 66X76	U	03693.9	81,13
340.0066.72	COUDE EGAL FF GALVA 90 80X90	U	03694.7	111,20



COUDE
MF - 90° - 92 - EN10242 - Galva



	DÉSIGNATION	UT	CODE	PPHT (€)
340.0003.25	COUDE EGAL MF GALVA 92 12X17	U	03732.5	5,42

ACIER

RACCORDS FONTE MALLEABLE GALVA



COUDE

MF - 90° - 92 - EN10242 - Galva
- suite



	DÉSIGNATION	UT	CODE	PPHT (€)
340.0002.28	COUDE EGAL MF GALVA 92 15X21	U	03733.3	3,80
340.0003.59	COUDE EGAL MF GALVA 92 20X27	U	03734.1	5,99
340.0005.96	COUDE EGAL MF GALVA 92 26X34	U	03735.8	9,93
340.0010.29	COUDE EGAL MF GALVA 92 33X42	U	03736.6	17,15
340.0015.39	COUDE EGAL MF GALVA 92 40X49	U	03737.4	25,65
340.0020.18	COUDE EGAL MF GALVA 92 50X60	U	03738.2	33,63
340.0050.22	COUDE EGAL MF GALVA 92 66X76	U	03740.8	83,70
340.0066.12	COUDE EGAL MF GALVA 92 80X90	U	03741.6	110,20



COUDE

FF - Union - 96 - EN10242 - Galva



	DÉSIGNATION	UT	CODE	PPHT (€)
340.0021.86	COUDE UNION FF GALVA 96 26X34	U	03798.6	36,43
340.0036.43	COUDE UNION FF GALVA 96 33X42	U	03799.4	60,71
340.0043.40	COUDE UNION FF GALVA 96 40X49	U	03800.0	72,34
340.0073.56	COUDE UNION FF GALVA 96 50X60	U	03801.8	122,60



COUDE

MF - Union - 98 - EN10242 - Galva



	DÉSIGNATION	UT	CODE	PPHT (€)
340.0016.79	COUDE UNION MF GALVA 98 20X27	U	03825.7	27,98
340.0023.11	COUDE UNION MF GALVA 98 26X34	U	03826.5	38,52
340.0038.53	COUDE UNION MF GALVA 98 33X42	U	03827.3	64,22
340.0047.17	COUDE UNION MF GALVA 98 40X49	U	03828.1	78,61
340.0078.32	COUDE UNION MF GALVA 98 50X60	U	03829.9	130,53



COURBE

MF - Grand rayon - 1 - EN10242 - Galva



	DÉSIGNATION	UT	CODE	PPHT (€)
340.0005.56	COURBE GR MF GALVA 1 15X21	U	03546.9	9,26
340.0009.52	COURBE GR MF GALVA 1 20X27	U	03547.7	15,87
340.0022.31	COURBE GR MF GALVA 1 33X42	U	03549.3	37,19
340.0029.50	COURBE GR MF GALVA 1 40X49	U	03550.1	49,16
340.0047.83	COURBE GR MF GALVA 1 50X60	U	03551.9	79,71

ACIER

RACCORDS FONTE MALLEABLE GALVA



COURBE

FF - Grand rayon - 2 - EN10242 - Galva



	DÉSIGNATION	UT	CODE	PPHT (€)
340.0006.16	COURBE GR FF GALVA 2 12X17	U	03573.3	10,26
340.0006.27	COURBE GR FF GALVA 2 15X21	U	03574.1	10,45
340.0009.66	COURBE GR FF GALVA 2 20X27	U	03575.8	16,10
340.0013.11	COURBE GR FF GALVA 2 26X34	U	03577.4	21,85
340.0022.40	COURBE GR FF GALVA 2 33X42	U	03578.2	37,34
340.0027.53	COURBE GR FF GALVA 2 40X49	U	03579.0	45,89



COURBE

MF - 45° - 40 - EN10242 - Galva



	DÉSIGNATION	UT	CODE	PPHT (€)
340.0006.27	COURBE A 45.MF GALVA 40 15X21	U	03631.9	10,45
340.0008.47	COURBE A 45.MF GALVA 40 20X27	U	03632.7	14,11
340.0086.27	COURBE A 45.MF GALVA 40 66X76	U	03638.4	143,78



COURBE

FF - 45° - 41 - EN10242 - Galva



	DÉSIGNATION	UT	CODE	PPHT (€)
340.0007.41	COURBE A 45.FF GALVA 41 15X21	U	03658.2	12,35
340.0009.35	COURBE A 45.FF GALVA 41 20X27	U	03659.0	15,58
340.0011.94	COURBE A 45.FF GALVA 41 26X34	U	03660.8	19,90
340.0021.38	COURBE A 45.FF GALVA 41 33X42	U	03661.6	35,63
340.0028.24	COURBE A 45.FF GALVA 41 40X49	U	03662.4	47,07
340.0079.09	COURBE A 45.FF GALVA 41 66X76	U	03665.7	131,81



CROIX

FFFF - 180 - EN10242 - Galva



	DÉSIGNATION	UT	CODE	PPHT (€)
340.0009.35	CROIX EGALE F GALVA 180 15X21	U	04131.9	15,58
340.0013.94	CROIX EGALE F GALVA 180 20X27	U	04132.7	23,23
340.0017.44	CROIX EGALE F GALVA 180 26X34	U	04133.5	29,07

ACIER

RACCORDS FONTE MALLEABLE GALVA



TE
FFF - Egal - 130 - EN10242 - Galva



	DÉSIGNATION	UT	CODE	PPHT (€)
340.0004.05	TE EGAL F GALVA 130 12X17	U	03851.3	6,75
340.0002.65	TE EGAL F GALVA 130 15X21	U	03852.1	4,42
340.0004.62	TE EGAL F GALVA 130 20X27	U	03853.9	7,70
340.0006.76	TE EGAL F GALVA 130 26X34	U	03854.7	11,26
340.0011.92	TE EGAL F GALVA 130 33X42	U	03855.4	19,86
340.0018.24	TE EGAL F GALVA 130 40X49	U	03856.2	30,40
340.0025.91	TE EGAL F GALVA 130 50X60	U	03857.0	43,18
340.0059.36	TE EGAL F GALVA 130 66X76	U	03859.6	98,94
340.0079.34	TE EGAL F GALVA 130 80X90	U	03860.4	132,24



TE
FFF - Réduit - 130R - EN10242 - Galva



	DÉSIGNATION	UT	CODE	PPHT (€)
340.0004.93	TE REDUIT F GALVA 130 20X15X20	U	03981.8	8,22
340.0006.38	TE REDUIT F GALVA 130 26X15X26	U	03993.3	10,64
340.0006.87	TE REDUIT F GALVA 130 26X20X26	U	03997.4	11,45
340.0010.66	TE REDUIT F GALVA 130 33X15X33	U	04007.1	17,77
340.0011.20	TE REDUIT F GALVA 130 33X20X33	U	04011.3	18,67
340.0012.62	TE REDUIT F GALVA 130 33X26X33	U	04014.7	21,04
340.0014.22	TE REDUIT F GALVA 130 40X15X40	U	04020.4	23,70
340.0015.28	TE REDUIT F GALVA 130 40X26X40	U	04022.0	25,46
340.0016.79	TE REDUIT F GALVA 130 40X26X40	U	04024.6	27,98
340.0022.66	TE REDUIT F GALVA 130 40X33X40	U	04028.7	37,76
340.0020.98	TE REDUIT F GALVA 130 50X15X50	U	04034.5	34,96
340.0027.02	TE REDUIT F GALVA 130 50X20X50	U	04035.2	45,03
340.0021.12	TE REDUIT F GALVA 130 50X26X50	U	04036.0	35,20
340.0031.15	TE REDUIT F GALVA 130 50X40X50	U	04040.2	51,92
340.0043.13	TE REDUIT F GALVA 130 66X40X66	U	20953.6	86,26



MANCHON
FF - 270 - EN10242 - Galva



	DÉSIGNATION	UT	CODE	PPHT (€)
340.0002.28	MANCHON GALVA 270 15X21	U	04422.2	3,80
340.0002.77	MANCHON GALVA 270 12X17	U	04421.4	4,61
340.0003.11	MANCHON GALVA 270 20X27	U	04423.0	5,18
340.0004.07	MANCHON GALVA 270 26X34	U	04424.8	6,79
340.0006.38	MANCHON GALVA 270 33X42	U	04425.5	10,64
340.0009.18	MANCHON GALVA 270 40X49	U	04426.3	15,30
340.0013.57	MANCHON GALVA 270 50X60	U	04427.1	22,61
340.0037.62	MANCHON GALVA 270 66X76	U	04429.7	62,70

ACIER

RACCORDS FONTE MALLEABLE GALVA



MANCHON
FF - 270 - EN10242 - Galva
- suite



	DÉSIGNATION	UT	CODE	PPHT (€)
340.0045.20	MANCHON GALVA 270 80X90	U	04430.5	75,34



MAMELON
MM - 280 - EN10242 - Galva



	DÉSIGNATION	UT	CODE	PPHT (€)
340.0003.34	MAMELON GALVA 280 8X13	U	04476.8	5,56
340.0003.79	MAMELON GALVA 280 12X17	U	04477.6	6,32
340.0002.02	MAMELON GALVA 280 15X21	U	04478.4	3,37
340.0002.59	MAMELON GALVA 280 20X27	U	04479.2	4,32
340.0003.73	MAMELON GALVA 280 26X34	U	04480.0	6,22
340.0006.30	MAMELON GALVA 280 33X42	U	04481.8	10,50
340.0007.27	MAMELON GALVA 280 40X49	U	04482.6	12,11
340.0013.11	MAMELON GALVA 280 50X60	U	04483.4	21,85
340.0023.80	MAMELON GALVA 280 66X76	U	04485.9	39,66
340.0028.64	MAMELON GALVA 280 80X90	U	04486.7	47,74



REDUCTION
FF - Réduit - 240R - EN10242 - Galva



	DÉSIGNATION	UT	CODE	PPHT (€)
340.0004.05	MANCHON REDUIT FF GALVA 240 15X8	U	04210.1	6,75
340.0003.99	MANCHON REDUIT FF GALVA 240 20X15	U	04214.3	6,65
340.0005.05	MANCHON REDUIT FF GALVA 240 26X15	U	04217.6	8,41
340.0004.64	MANCHON REDUIT FF GALVA 240 26X20	U	04218.4	7,74
340.0009.49	MANCHON REDUIT FF GALVA 240 33X15	U	04220.0	15,82
340.0008.38	MANCHON REDUIT FF GALVA 240 33X20	U	04221.8	13,97
340.0008.18	MANCHON REDUIT FF GALVA 240 33X26	U	04222.6	13,63
340.0012.94	MANCHON REDUIT FF GALVA 240 40X20	U	04225.9	21,57
340.0009.92	MANCHON REDUIT FF GALVA 240 40X26	U	04226.7	16,53
340.0010.86	MANCHON REDUIT FF GALVA 240 40X33	U	04227.5	18,10
340.0019.46	MANCHON REDUIT FF GALVA 240 50X26	U	04229.1	32,44
340.0017.10	MANCHON REDUIT FF GALVA 240 50X33	U	04230.9	28,50
340.0016.33	MANCHON REDUIT FF GALVA 240 50X40	U	04231.7	27,22

ACIER

RACCORDS FONTE MALLEABLE GALVA



REDUCTION

MF - Réduit - 241R - EN10242 - Galva



	DÉSIGNATION	UT	CODE	PPHT (€)
340.0002.59	MAMELON REDUIT MF GALVA 241 12X8	U	04284.6	4,32
340.0002.00	MAMELON REDUIT MF GALVA 241 15X8	U	04286.1	3,33
340.0002.02	MAMELON REDUIT MF GALVA 241 15X12	U	04287.9	3,37
340.0002.77	MAMELON REDUIT MF GALVA 241 20X12	U	04290.3	4,61
340.0002.14	MAMELON REDUIT MF GALVA 241 20X15	U	44840.7	3,56
340.0004.56	MAMELON REDUIT MF GALVA 241 26X12	U	44857.1	7,60
340.0002.99	MAMELON REDUIT MF GALVA 241 26X15	U	04291.1	4,99
340.0002.82	MAMELON REDUIT MF GALVA 241 26X20	U	04292.9	4,70
340.0005.08	MAMELON REDUIT MF GALVA 241 33X15	U	04294.5	8,46
340.0004.53	MAMELON REDUIT MF GALVA 241 33X20	U	04295.2	7,55
340.0003.45	MAMELON REDUIT MF GALVA 241 33X26	U	04296.0	5,75
340.0006.73	MAMELON REDUIT MF GALVA 241 40X15	U	04298.6	11,21
340.0007.44	MAMELON REDUIT MF GALVA 241 40X20	U	04299.4	12,40
340.0005.05	MAMELON REDUIT MF GALVA 241 40X26	U	04300.0	8,41
340.0005.10	MAMELON REDUIT MF GALVA 241 40X33	U	04301.8	8,50
340.0013.54	MAMELON REDUIT MF GALVA 241 50X15	U	04303.4	22,56
340.0013.28	MAMELON REDUIT MF GALVA 241 50X20	U	04304.2	22,14
340.0010.97	MAMELON REDUIT MF GALVA 241 50X26	U	04305.9	18,29
340.0010.46	MAMELON REDUIT MF GALVA 241 50X33	U	04306.7	17,43
340.0009.41	MAMELON REDUIT MF GALVA 241 50X40	U	04307.5	15,68
340.0021.63	MAMELON REDUIT MF GALVA 241 66X26	U	04311.7	36,05
340.0023.63	MAMELON REDUIT MF GALVA 241 66X40	U	04313.3	39,38
340.0018.21	MAMELON REDUIT MF GALVA 241 66X50	U	04314.1	30,35
340.0031.43	MAMELON REDUIT MF GALVA 241 80X40	U	04317.4	52,39
340.0023.48	MAMELON REDUIT MF GALVA 241 80X50	U	04318.2	39,14
340.0026.42	MAMELON REDUIT MF GALVA 241 80X66	U	04320.8	44,03



REDUCTION

MM - Réduit - 245R - EN10242 - Galva



	DÉSIGNATION	UT	CODE	PPHT (€)
340.0004.70	MAMELON REDUIT MM GALVA 245 15X12	U	04347.1	7,84
340.0008.32	MAMELON REDUIT MM GALVA 245 20X12	U	04350.5	13,87
340.0004.10	MAMELON REDUIT MM GALVA 245 20X15	U	04351.3	6,84
340.0008.27	MAMELON REDUIT MM GALVA 245 26X15	U	04353.9	13,78
340.0004.73	MAMELON REDUIT MM GALVA 245 26X20	U	04354.7	7,89
340.0010.72	MAMELON REDUIT MM GALVA 245 33X20	U	04357.0	17,86
340.0007.47	MAMELON REDUIT MM GALVA 245 33X26	U	04358.8	12,45
340.0010.86	MAMELON REDUIT MM GALVA 245 40X20	U	04360.4	18,10
340.0017.36	MAMELON REDUIT MM GALVA 245 40X26	U	04361.2	28,93
340.0009.35	MAMELON REDUIT MM GALVA 245 40X33	U	04362.0	15,58
340.0015.53	MAMELON REDUIT MM GALVA 245 50X26	U	04363.8	25,89
340.0019.33	MAMELON REDUIT MM GALVA 245 50X33	U	04364.6	32,21
340.0017.78	MAMELON REDUIT MM GALVA 245 50X40	U	04365.3	29,64
340.0043.04	MAMELON REDUIT MM GALVA 245 66X50	U	42367.3	71,73
340.0052.64	MAMELON REDUIT MM GALVA 245 80X50	U	04080.8	87,73

ACIER

RACCORDS FONTE MALLEABLE GALVA



REDUCTION

FM - Réduit - 246R - EN10242 - Galva



	DÉSIGNATION	UT	CODE	PPHT (€)
340.0003.82	MANCHON REDUIT FM GALVA 246 15X12	U	04389.3	6,37
340.0004.05	MANCHON REDUIT FM GALVA 246 20X15	U	04391.9	6,75
340.0006.22	MANCHON REDUIT FM GALVA 246 26X15	U	04393.5	10,36
340.0006.61	MANCHON REDUIT FM GALVA 246 26X20	U	04394.3	11,02
340.0011.69	MANCHON REDUIT FM GALVA 246 33X20	U	04396.8	19,48
340.0007.33	MANCHON REDUIT FM GALVA 246 33X26	U	04397.6	12,21
340.0013.94	MANCHON REDUIT FM GALVA 246 40X26	U	04400.8	23,23
340.0019.75	MANCHON REDUIT FM GALVA 246 50X33	U	04403.2	32,92
340.0020.98	MANCHON REDUIT FM GALVA 246 50X40	U	04404.0	34,96



BOUCHON

Mâle - 290 - EN10242 - Galva



	DÉSIGNATION	UT	CODE	PPHT (€)
340.0001.57	BOUCHON MALE GALVA 290 12X17	U	04532.8	2,61
340.0001.57	BOUCHON MALE GALVA 290 15X21	U	04533.6	2,61
340.0002.14	BOUCHON MALE GALVA 290 20X27	U	04535.1	3,56
340.0002.36	BOUCHON MALE GALVA 290 26X34	U	04536.9	3,94
340.0004.42	BOUCHON MALE GALVA 290 33X42	U	04537.7	7,36
340.0005.44	BOUCHON MALE GALVA 290 40X49	U	04538.5	9,07
340.0009.55	BOUCHON MALE GALVA 290 50X60	U	04539.3	15,91
340.0020.98	BOUCHON MALE GALVA 290 66X76	U	04541.9	34,96



BOUCHON

Femelle - 300 - EN10242 - Galva



	DÉSIGNATION	UT	CODE	PPHT (€)
340.0002.42	BOUCHON FEMELLE GALVA 300 8X13	U	04588.0	4,04
340.0002.28	BOUCHON FEMELLE GALVA 300 12X17	U	04589.8	3,80
340.0002.54	BOUCHON FEMELLE GALVA 300 15X21	U	04590.6	4,23
340.0003.08	BOUCHON FEMELLE GALVA 300 20X27	U	04591.4	5,13
340.0003.59	BOUCHON FEMELLE GALVA 300 26X34	U	04592.2	5,99
340.0005.33	BOUCHON FEMELLE GALVA 300 33X42	U	04593.0	8,88
340.0006.64	BOUCHON FEMELLE GALVA 300 40X49	U	04594.8	11,07
340.0012.57	BOUCHON FEMELLE GALVA 300 50X60	U	04595.5	20,95
340.0023.17	BOUCHON FEMELLE GALVA 300 66X76	U	04597.1	38,62
340.0025.11	BOUCHON FEMELLE GALVA 300 80X90	U	04598.9	41,85

ACIER

RACCORDS FONTE MALLEABLE GALVA



RACCORD UNION

MF - 331 - A joint plat - EN10242 - Galva



	DÉSIGNATION	UT	CODE	PPHT (€)
340.0010.52	UNION MF GALVA 331 20X27	U	04675.5	17,53
340.0012.74	UNION MF GALVA 331 26X34	U	04676.3	21,23
340.0023.00	UNION MF GALVA 331 33X42	U	04677.1	38,33
340.0027.73	UNION MF GALVA 331 40X49	U	04678.9	46,22
340.0043.38	UNION MF GALVA 331 50X60	U	04679.7	72,30



RACCORD UNION

FF - 340 - EN10242 - Galva



	DÉSIGNATION	UT	CODE	PPHT (€)
340.0012.91	UNION FF GALVA 340 12X17	U	04701.9	21,52
340.0009.89	UNION FF GALVA 340 15X21	U	04702.7	16,48
340.0011.23	UNION FF GALVA 340 20X27	U	04703.5	18,72
340.0012.94	UNION FF GALVA 340 26X34	U	04704.3	21,57
340.0022.26	UNION FF GALVA 340 33X42	U	04705.0	37,10
340.0026.05	UNION FF GALVA 340 40X49	U	04706.8	43,42
340.0042.83	UNION FF GALVA 340 50X60	U	04707.6	71,39
340.0093.97	UNION FF GALVA 340 66X76	U	04709.2	156,61
340.0131.05	UNION FF GALVA 340 80X90	U	04710.0	218,41



RACCORD UNION

MF - 341 - EN10242 - Galva



	DÉSIGNATION	UT	CODE	PPHT (€)
340.0011.60	UNION MF GALVA 341 12X17	U	22748.8	19,33
340.0009.66	UNION MF GALVA 341 15X21	U	22749.6	16,10
340.0011.63	UNION MF GALVA 341 20X27	U	22750.4	19,38
340.0014.45	UNION MF GALVA 341 26X34	U	22751.2	24,08
340.0022.97	UNION MF GALVA 341 33X42	U	22746.2	38,29
340.0029.41	UNION MF GALVA 341 40X49	U	22747.0	49,02
340.0046.88	UNION MF GALVA 341 50X60	U	22752.0	78,14
340.0102.60	UNION MF GALVA 341 66X76	U	22745.4	171,00
340.0160.43	UNION MF GALVA 341 80X90	U	22753.8	267,38

ACIER

RACCORDS FONTE MALLEABLE GALVA



RACCORD UNION

MM - 344 - EN10242 - Galva



	DÉSIGNATION	UT	CODE	PPHT (€)
340.0024.77	UNION MM GALVA 344 26X34	U	04746.4	41,28
340.0042.98	UNION MM GALVA 344 33X42	U	04747.2	71,63
340.0047.88	UNION MM GALVA 344 40X49	U	04748.0	79,80
340.0087.89	UNION MM GALVA 344 50X60	U	04749.8	146,49



RACCORD UNION

Femelle - Type I - PN10



	DÉSIGNATION	UT	CODE	PPHT (€)
000.0014.95	RACCORD UNION FEM.1 3/8 GEBO 011500100	U	82731.1	24,12
000.0015.32	RACCORD UNION FEM.1 1/2 GEBO 011500101	U	98552.3	24,71
000.0019.24	RACCORD UNION FEM.1 3/4 GEBO 011500102	U	98553.1	31,04
000.0020.01	RACCORD UNION FEM.1 1" GEBO 011500103	U	98554.9	32,28
000.0028.67	RACCORD UNION FEM.1 1"1/4 GEBO 011500104	U	98555.6	46,25
358.0033.90	RACCORD UNION FEM.1 1"1/2 GEBO 011500105	U	98556.4	54,67
000.0054.68	RACCORD UNION FEM.1 2" GEBO 011500106	U	98557.2	88,20



RACCORD UNION

Femelle - Type I - PN16



	DÉSIGNATION	UT	CODE	PPHT (€)
000.0095.40	BRIDE UNION FEM.IF 2"1/2 GEBO 012200107	U	33794.9	153,87
000.0131.20	BRIDE UNION FEM.IF 3" GEBO 012200108	U	72844.4	211,62



RACCORD UNION

Mâle - Type A - PN10



	DÉSIGNATION	UT	CODE	PPHT (€)
000.0014.95	RACCORD UNION MALE A 3/8 GEBO 011500000	U	82733.7	24,12
000.0015.32	RACCORD UNION MALE A 1/2 GEBO 011500001	U	98546.5	24,71
000.0019.24	RACCORD UNION MALE A 3/4 GEBO 011500002	U	98547.3	31,04
000.0020.01	RACCORD UNION MALE A 1" GEBO 011500003	U	98548.1	32,28
000.0028.67	RACCORD UNION MALE A 1"1/4 GEBO 011500004	U	98549.9	46,25
000.0033.90	RACCORD UNION MALE A 1"1/2 GEBO 011500005	U	98550.7	54,67
000.0054.68	RACCORD UNION MALE A 2" GEBO 011500006	U	98551.5	88,20

ACIER

RACCORDS FONTE MALLEABLE GALVA

gebo
FITS BETTER!

RACCORD UNION

Mâte - Type A - PN16



	DÉSIGNATION	UT	CODE	PPHT (€)
000.0095.40	BRIDE UNION MALE AF 2"1/2 GEB0 012200007	U	36348.1	153,87
000.0131.20	BRIDE UNION MALE AF 3" GEB0 012200008	U	72525.9	211,62

gebo
FITS BETTER!

RACCORD UNION

Droit - Type O - PN10



	DÉSIGNATION	UT	CODE	PPHT (€)
000.0022.60	MANCHON UNION O 1/2 GEB0 011500201	U	98538.2	36,45
000.0025.18	MANCHON UNION O 3/4 GEB0 011500202	U	98539.0	40,61
000.0020.07	MANCHON UNION O 3/8 GEB0 011500200	U	82734.5	32,37
000.0028.17	MANCHON UNION O 1" GEB0 011500203	U	98540.8	45,43
000.0045.19	MANCHON UNION O 1"1/2 GEB0 011500205	U	98542.4	72,88
000.0036.93	MANCHON UNION O 1"1/4 GEB0 011500204	U	98541.6	59,57
000.0068.30	MANCHON UNION O 2" GEB0 011500206	U	98543.2	110,16

gebo
FITS BETTER!

RACCORD UNION

Droit - Type O - PN16



	DÉSIGNATION	UT	CODE	PPHT (€)
000.0155.50	BRIDE UNION OF 2"1/2 GEB0 012200207	U	36346.5	250,80
000.0206.11	BRIDE UNION OF 3" GEB0 012200208	U	72729.7	332,44

TUBES ACIER NOIR



TUBE S195 T1 ACIER SOUDE SANS FILETAGE

Norme W-EN10255 - Noir - Mètre



	DÉSIGNATION	UT	CODE	PPHT (€)
041.0003.14	TUBE SOUD.S195T T1 NBL W-EN10255 17.2X2.00	M	00562.9	5,71
041.0003.99	TUBE SOUD.S195T T1 NBL W-EN10255 21.3X2.30	M	00563.7	7,26
041.0003.98	TUBE SOUD.S195T T1 NBL W-EN10255 26.9X2.30	M	00564.5	7,23
041.0005.70	TUBE SOUD.S195T T1 NBL W-EN10255 33.7X2.90	M	00565.2	10,36
041.0006.80	TUBE SOUD.S195T T1 NBL W-EN10255 42.4X2.90	M	00566.0	12,36
041.0008.95	TUBE SOUD.S195T T1 NBL W-EN10255 48.3X2.90	M	00567.8	16,28
041.0010.43	TUBE SOUD.S195T T1 NBL W-EN10255 60.3X3.20	M	00568.6	18,96

ACIER

TUBES ACIER NOIR



TUBE S195 T2 ACIER SOUDE SANS FILETAGE

Norme W-EN10255 - Noir



	DÉSIGNATION	UT	CODE	PPHT (€)
041.0014.83	TUBE SOUD.S195T NBL W-EN10255 76.1X3.20	M	00570.2	26,96
041.0017.18	TUBE SOUD.S195T NBL W-EN10255 88.9X3.20	M	00571.0	31,24
041.0027.48	TUBE SOUD.S195T NBL W-EN10255 114.3X3.60	M	00573.6	49,96



TUBE S195 T3 ACIER SANS SOUDURE, SANS FILETAGE

Norme S-EN10255 - Noir



	DÉSIGNATION	UT	CODE	PPHT (€)
061.0005.31	TUBE SS S195T NBL S-EN10255 21.3X2.60	M	00638.7	9,66
061.0008.11	TUBE SS S195T NBL S-EN10255 26.9X2.60	M	00639.5	14,74
061.0008.82	TUBE SS S195T NBL S-EN10255 33.7X3.20	M	00640.3	16,04
061.0014.46	TUBE SS S195T NBL S-EN10255 42.4X3.20	M	00641.1	26,29
061.0016.65	TUBE SS S195T NBL S-EN10255 48.3X3.20	M	00642.9	30,28
061.0020.28	TUBE SS S195T NBL S-EN10255 60.3X3.60	M	00643.7	36,88
061.0022.68	TUBE SS S195T NBL S-EN10255 76.1X3.60	M	00645.2	41,24
061.0037.00	TUBE SS S195T NBL S-EN10255 88.9X4.00	M	00646.0	67,28



TUBE P235 TR1 T10 ACIER SANS SOUDURE, SANS FILETAGE

Norme S-EN10216-1 - Noir



	DÉSIGNATION	UT	CODE	PPHT (€)
061.0050.31	TUBE SANS SOUDURE EN10216-1 1L 139.7X4.0	M	24194.3	91,48
061.0066.07	TUBE SANS SOUDURE EN10216-1 1L 168.0X4.5	M	24198.4	120,12

RACCORDS ACIER NOIR A SOUDER



COURBE

3D - 90° - Sans soudure - EN10253-1 - Noir



	DÉSIGNATION	UT	CODE	PPHT (€)
345.0001.98	COURBE A SOUDER NF EN10253-1 3D 90 21,3	U	04837.1	3,30
345.0002.01	COURBE A SOUDER NF EN10253-1 3D 90 26,9	U	04838.9	3,35
345.0002.34	COURBE A SOUDER NF EN10253-1 3D 90 33,7	U	04839.7	3,90
345.0002.79	COURBE A SOUDER NF EN10253-1 3D 90 42,4	U	04841.3	4,65
345.0003.51	COURBE A SOUDER NF EN10253-1 3D 90 48,3	U	04843.9	5,85
345.0004.89	COURBE A SOUDER NF EN10253-1 3D 90 60,3	U	04846.2	8,15

ACIER

RACCORDS ACIER NOIR A SOUDER



COURBE

3D - 90° - Sans soudure - EN10253-1 - Noir - suite



	DÉSIGNATION	UT	CODE	PPHT (€)
345.0007.35	COURBE A SOUDER NF EN10253-1 3D 90 76,1	U	04848.8	12,25
345.0010.92	COURBE A SOUDER NF EN10253-1 3D 90 88,9	U	04849.6	18,20
345.0020.64	COURBE A SOUDER NF EN10253-1 3D 90 114,3	U	04852.0	34,40
345.0037.14	COURBE A SOUDER NF EN10253-1 3D 90 139,7	U	04854.6	61,90
345.0058.47	COURBE A SOUDER NF EN10253-1 3D 90 168,3	U	04856.1	97,45



COURBE

3D - 90° - Sans soudure - EN10253-2



	DÉSIGNATION	UT	CODE	PPHT (€)
000.0001.44	COURBE 3D 90 EN10253-2 P235GH ATG 26.9X2.6	U	317C4.7	1,44
000.0003.60	COURBE 3D 90 EN10253-2 P235GH ATG 33.7X3.2	U	317C5.4	3,60
000.0004.41	COURBE 3D 90 EN10253-2 P235GH ATG 42.4X3.6	U	317C6.2	4,41
000.0004.76	COURBE 3D 90 EN10253-2 P235GH ATG 48.3X3.6	U	317C7.0	4,76
000.0006.14	COURBE 3D 90 EN10253-2 P235GH ATG 60.3X3.6	U	317C8.8	6,14
000.0012.75	COURBE 3D 90 EN10253-2 P235GH ATG 88.9X4.0	U	317CA.3	12,75



TE

Sans soudure - EN10253-1 - Noir



	DÉSIGNATION	UT	CODE	PPHT (€)
345.0023.52	TE SANS SOUDURE A SOUDER 26.9X2.00	U	67682.5	39,20



REDUCTION

Concentrique - Sans soudure - EN10253-1 - Noir



	DÉSIGNATION	UT	CODE	PPHT (€)
345.0004.89	REDUCTION CONCENTRIQ.NF EN10253-1 33,7-26,9	U	04949.4	8,15
345.0006.99	REDUCTION CONCENTRIQ.NF EN10253-1 42,4-26,9	U	04950.2	11,65
345.0006.03	REDUCTION CONCENTRIQ.NF EN10253-1 42,4-33,7	U	04973.4	10,05
345.0007.80	REDUCTION CONCENTRIQ.NF EN10253-1 48,3-26,9	U	04952.8	13,00
345.0006.75	REDUCTION CONCENTRIQ.NF EN10253-1 48,3-33,7	U	04953.6	11,25
345.0006.21	REDUCTION CONCENTRIQ.NF EN10253-1 48,3-42,4	U	20898.3	10,35
345.0009.21	REDUCTION CONCENTRIQ.NF EN10253-1 60,3-33,7	U	20879.3	15,35
345.0007.35	REDUCTION CONCENTRIQ.NF EN10253-1 60,3-42,4	U	04955.1	12,25
345.0006.96	REDUCTION CONCENTRIQ.NF EN10253-1 60,3-48,3	U	04957.7	11,60
345.0011.22	REDUCTION CONCENTRIQ.NF EN10253-1 76,1-42,4	U	20883.5	18,70

ACIER

RACCORDS ACIER NOIR A SOUDER



REDUCTION

Concentrique - Sans soudure - EN10253-1 - Noir - suite



	DÉSIGNATION	UT	CODE	PPHT (€)
345.0009.69	REDUCTION CONCENTRIQ.NF EN10253-1 76,1-48,3	U	68205.4	16,15
345.0008.16	REDUCTION CONCENTRIQ.NF EN10253-1 76,1-60,3	U	04961.9	13,60
345.0011.19	REDUCTION CONCENTRIQ.NF EN10253-1 88,9-60,3	U	04963.5	18,65
345.0009.18	REDUCTION CONCENTRIQ.NF EN10253-1 88,9-76,1	U	21019.5	15,30
345.0019.11	REDUCTION CONCENTRIQ.NF EN10253-1 114,3-76,1	U	21014.6	31,85
345.0015.57	REDUCTION CONCENTRIQ.NF EN10253-1 114,3-88,9	U	04972.6	25,95
345.0022.77	REDUCTION CONCENTRIQ.NF EN10253-1 139,7-114,3	U	72992.1	37,95
345.0039.87	REDUCTION CONCENTRIQ.NF EN10253-1 168,3-114,3	U	04984.1	66,45
345.0033.69	REDUCTION CONCENTRIQ.NF EN10253-1 168,3-139,7	U	27262.5	56,15
345.0095.10	REDUCTION CONCENTRIQ.NF EN10253-1 273,0-219,1	U	04991.6	158,50



REDUCTION

EN10253-2 P235GH ATG



	DÉSIGNATION	UT	CODE	PPHT (€)
000.0011.21	RED. EN10253-2 P235GH ATG 33.7X3.2-26.9X2.6	U	317CU.4	11,21
000.0012.41	RED. EN10253-2 P235GH ATG 42.4X3.6-33.7X3.2	U	317CV.2	12,41
000.0012.99	RED. EN10253-2 P235GH ATG 48.3X3.6-42.4X3.6	U	317CW.0	12,99
000.0021.47	RED. EN10253-2 P235GH ATG 60.3X3.6-48.3X3.6	U	317CX.8	21,47
000.0018.29	RED. EN10253-2 P235GH ATG 88.9X4.0-60.3X3.6	U	317EU.2	18,29



BRIDE PLATE

Face droite sans portée de joint - Type 01A - EN1092-1 - PN16 - Noir



	DÉSIGNATION	UT	CODE	PPHT (€)
345.0042.80	BRIDE PLATE NORMALE NOIRE PN16 DN100	U	2895A.2	71,33



BRIDE A COLLERETTE BOUT A BOUT

Alésage droit - Face de joint surélevée dressée - Type 11B - EN1092-1 - PN16 - Noir



	DÉSIGNATION	UT	CODE	PPHT (€)
345.0025.83	BRIDE A COLL. PN10-16-1FD- DN 50TUB 60,3-E165	U	05274.6	43,05
345.0029.22	BRIDE A COLL. PN10-16-1FD- DN 65TUB 76 -E185	U	05275.3	48,70
345.0037.89	BRIDE A COLL. PN10-16-1FD- DN 80TUB88,9 -E200	U	05276.1	63,15
345.0044.64	BRIDE A COLL. PN10-16-1FD-DN100TUB114-E 220	U	16426.9	74,40

ACIER

RACCORDS ACIER NOIR A SOUDER



BRIDE A COLLERETTE BOUT A BOUT

Alésage droit - Face de joint surélevée dressée - Type 11B - EN1092-1 - PN16 - Noir - suite



	DÉSIGNATION	UT	CODE	PPHT (€)
345.0058.77	BRIDE A COLL. PN10-16-1FD-DN125-TUB139,7-E250	U	05279.5	97,95
345.0075.27	BRIDE A COLL. PN10-16-1FD-DN150-TUB168,3-E285	U	16427.7	125,45



BRIDE A COLLERETTE BOUT A BOUT

Alésage droit - Face de joint surélevée dressée - Type 11B - EN1092-1 - PN40 - Noir



	DÉSIGNATION	UT	CODE	PPHT (€)
345.0022.35	BRIDE A COLL. PN25-40 1FD DN 32 TUB42,4 E 100	U	71661.3	37,25
345.0025.11	BRIDE A COLL. PN25-40 1FD DN 40 TUB48,3 E 110	U	71664.7	41,85



FOND

Bombé à souder - EN10253-1 - Noir



	DÉSIGNATION	UT	CODE	PPHT (€)
345.0000.93	FOND BOMBE NF EN10253-1 26,9	U	18014.1	1,55
345.0000.99	FOND BOMBE NF EN10253-1 33,7	U	05009.6	1,65
345.0001.20	FOND BOMBE NF EN10253-1 42,4	U	05011.2	2,00
345.0001.23	FOND BOMBE NF EN10253-1 48,3	U	05012.0	2,05
345.0001.80	FOND BOMBE NF EN10253-1 60,3	U	05015.3	3,00
345.0002.55	FOND BOMBE NF EN10253-1 76,1	U	05017.9	4,25
345.0003.21	FOND BOMBE NF EN10253-1 88,9	U	05018.7	5,35
345.0006.45	FOND BOMBE NF EN10253-1 114,3	U	05021.1	10,75

RACCORDS ACIER NOIR A VISSER



MANCHON

Filetage cylindrique - 270 - EN10241 - Noir



	DÉSIGNATION	UT	CODE	PPHT (€)
345.0000.84	MANCHON FER NOIR 12X17	U	05165.6	1,40
345.0000.84	MANCHON FER NOIR 15X21	U	05166.4	1,40

ACIER

RACCORDS ACIER NOIR A VISSER



MANCHON

Filetage cylindrique - 270 - EN10241 - Noir - suite



	DÉSIGNATION	UT	CODE	PPHT (€)
345.0001.14	MANCHON FER NOIR 20X27	U	05167.2	1,90
345.0001.98	MANCHON FER NOIR 26X34	U	05168.0	3,30
345.0002.70	MANCHON FER NOIR 33X42	U	05169.8	4,50
345.0003.09	MANCHON FER NOIR 40X49	U	05170.6	5,15
345.0004.32	MANCHON FER NOIR 50X60	U	05171.4	7,20
345.0006.90	MANCHON FER NOIR 66X76	U	05173.0	11,50



MAMELON

Filetage conique - 530 - EN10241 - Noir



	DÉSIGNATION	UT	CODE	PPHT (€)
345.0001.89	MAMELON 530 NOIR 26X34 50	U	21235.7	3,15
345.0001.59	MAMELON 530 NOIR 12X17 100	U	05037.7	2,65
345.0001.59	MAMELON 530 NOIR 15X21 100	U	05050.0	2,65
345.0002.22	MAMELON 530 NOIR 20X27 100	U	05062.5	3,70
345.0002.88	MAMELON 530 NOIR 26X34 100	U	05074.0	4,80
345.0003.87	MAMELON 530 NOIR 33X42 100	U	05085.6	6,45
345.0004.50	MAMELON 530 NOIR 40X49 100	U	05095.5	7,50
345.0006.12	MAMELON 530 NOIR 50X60 100	U	05106.0	10,20
345.0002.28	MAMELON 530 NOIR 12X17 150	U	05041.9	3,80
345.0002.34	MAMELON 530 NOIR 15X21 150	U	05054.2	3,90
345.0002.76	MAMELON 530 NOIR 20X27 150	U	05066.6	4,60
345.0003.78	MAMELON 530 NOIR 26X34 150	U	05078.1	6,30
345.0004.89	MAMELON 530 NOIR 33X42 150	U	05088.0	8,15
345.0005.70	MAMELON 530 NOIR 40X49 150	U	05099.7	9,50
345.0008.22	MAMELON 530 NOIR 50X60 150	U	05109.4	13,70
345.0002.82	MAMELON 530 NOIR 12X17 200	U	05044.3	4,70
345.0002.97	MAMELON 530 NOIR 15X21 200	U	05057.5	4,95
345.0003.45	MAMELON 530 NOIR 20X27 200	U	05069.0	5,75
345.0004.68	MAMELON 530 NOIR 26X34 200	U	05080.7	7,80
345.0006.39	MAMELON 530 NOIR 33X42 200	U	05091.4	10,65
345.0010.95	MAMELON 530 NOIR 50X60 200	U	05111.0	18,25
345.0007.50	MAMELON 530 NOIR 40X49 200	U	05102.9	12,50
345.0015.12	MAMELON 530 NOIR 66X76 200	U	05125.0	25,20
345.0018.57	MAMELON 530 NOIR 80X90 200	U	05132.6	30,95
345.0008.73	MAMELON 530 NOIR 40X49 250	U	05103.7	14,55
345.0012.72	MAMELON 530 NOIR 50X60 250	U	05112.8	21,20
345.0007.35	MAMELON 530 NOIR 33X42 250	U	44974.4	12,25
345.0017.22	MAMELON 530 NOIR 66X76 250	U	05126.8	28,70
345.0003.78	MAMELON 530 NOIR 15X21 300	U	86443.9	6,30
345.0014.70	MAMELON 530 NOIR 50X60 300	U	44951.2	24,50
345.0019.65	MAMELON 530 NOIR 66X76 300	U	05127.6	32,75
345.0024.63	MAMELON 530 NOIR 80X90 300	U	05134.2	41,05

ACIER

RACCORDS ACIER NOIR A VISSER



BRIDE PLEINE

Normale - Noir - PN16



	DÉSIGNATION	UT	CODE	PPHT (€)
345.0042.37	BRIDE PLEINE NORMALE NOIRE PN16 DN80	U	2894E.4	70,61
345.0054.70	BRIDE PLEINE NORMALE NOIRE PN16 DN100	U	2894F.2	91,17



BRIDE TARAUEE

Face de joint surélevée dressée - Noir - PN16



	DÉSIGNATION	UT	CODE	PPHT (€)
345.0026.18	BRIDE A COLLERETTE PN16 A VISSER NOIRE 50X60	U	2897H.5	43,63
345.0040.37	BRIDE A COLLERETTE PN16 A VISSER NOIRE 80X90	U	2897J.2	67,28



BRIDE TARAUEE

Face de joint surélevée dressée - Noir - PN40



	DÉSIGNATION	UT	CODE	PPHT (€)
345.0022.96	BRIDE A COLLERETTE PN40 A VISSER NOIRE 40X49	U	28976.7	38,27

RACCORDS FONTE MALLEABLE NOIR



COUDE

FF - 90° - 90 - EN10242 - Noir



	DÉSIGNATION	UT	CODE	PPHT (€)
340.0002.28	COUDE EGAL FF NOIR N 90 12X17	U	03671.5	3,80
340.0001.48	COUDE EGAL FF NOIR N 90 15X21	U	03672.3	2,47
340.0002.36	COUDE EGAL FF NOIR N 90 20X27	U	03673.1	3,94
340.0003.62	COUDE EGAL FF NOIR N 90 26X34	U	03674.9	6,03
340.0007.07	COUDE EGAL FF NOIR N 90 33X42	U	03675.6	11,78
340.0011.40	COUDE EGAL FF NOIR N 90 40X49	U	03676.4	19,00
340.0013.17	COUDE EGAL FF NOIR N 90 50X60	U	03677.2	21,95

ACIER

RACCORDS FONTE MALLEABLE NOIR



COUDE

MF - 90° - 92 - EN10242 - Noir



	DÉSIGNATION	UT	CODE	PPHT (€)
340.0002.77	COUDE EGAL MF NOIR N 92 12X17	U	03718.4	4,61
340.0001.91	COUDE EGAL MF NOIR N 92 15X21	U	03719.2	3,18
340.0002.91	COUDE EGAL MF NOIR N 92 20X27	U	03720.0	4,85
340.0004.64	COUDE EGAL MF NOIR N 92 26X34	U	03721.8	7,74
340.0008.44	COUDE EGAL MF NOIR N 92 33X42	U	03722.6	14,06
340.0012.28	COUDE EGAL MF NOIR N 92 40X49	U	03723.4	20,47
340.0015.96	COUDE EGAL MF NOIR N 92 50X60	U	03724.2	26,60



COUDE

FF - Union - 96 - EN10242 - Noir



	DÉSIGNATION	UT	CODE	PPHT (€)
340.0010.43	COUDE UNION FF NOIR N 96 15X21	U	03782.0	17,39
340.0012.05	COUDE UNION FF NOIR N 96 20X27	U	03783.8	20,09
340.0017.39	COUDE UNION FF NOIR N 96 26X34	U	03784.6	28,98
340.0029.27	COUDE UNION FF NOIR N 96 33X42	U	03785.3	48,78
340.0034.28	COUDE UNION FF NOIR N 96 40X49	U	03786.1	57,14
340.0057.77	COUDE UNION FF NOIR N 96 50X60	U	03787.9	96,28



COUDE

MF - Union - 98 - EN10242 - Noir



	DÉSIGNATION	UT	CODE	PPHT (€)
340.0010.46	COUDE UNION MF NOIR N 98 15X21	U	03810.9	17,43
340.0013.40	COUDE UNION MF NOIR N 98 20X27	U	03811.7	22,33
340.0018.30	COUDE UNION MF NOIR N 98 26X34	U	03812.5	30,50
340.0030.27	COUDE UNION MF NOIR N 98 33X42	U	03813.3	50,45
340.0037.91	COUDE UNION MF NOIR N 98 40X49	U	03814.1	63,18
340.0061.53	COUDE UNION MF NOIR N 98 50X60	U	03815.8	102,55



COURBE

MF - Grand rayon - 1 - EN10242 - Noir



	DÉSIGNATION	UT	CODE	PPHT (€)
340.0004.93	COURBE GR MF NOIR N 1 12X17	U	03531.1	8,22
340.0004.45	COURBE GR MF NOIR N 1 15X21	U	03532.9	7,41
340.0007.58	COURBE GR MF NOIR N 1 20X27	U	03533.7	12,64
340.0010.32	COURBE GR MF NOIR N 1 26X34	U	03534.5	17,20

ACIER

RACCORDS FONTE MALLEABLE NOIR



COURBE

FF - Grand rayon - 2 - EN10242 - Noir



	DÉSIGNATION	UT	CODE	PPHT (€)
340.0005.08	COURBE GR FF NOIR N 2 15X21	U	03560.0	8,46



COURBE

MF - 45° - 40 - EN10242 - Noir



	DÉSIGNATION	UT	CODE	PPHT (€)
340.0005.08	COURBE A 45.MF NOIR N 40 15X21	U	03617.8	8,46
340.0006.81	COURBE A 45.MF NOIR N 40 20X27	U	03618.6	11,35
340.0009.52	COURBE A 45.MF NOIR N 40 26X34	U	03619.4	15,87
340.0016.56	COURBE A 45.MF NOIR N 40 33X42	U	03620.2	27,60
340.0019.87	COURBE A 45.MF NOIR N 40 40X49	U	03621.0	33,11
340.0030.86	COURBE A 45.MF NOIR N 40 50X60	U	03622.8	51,44



TE

FFF - Egal - 130 - EN10242 - Noir



	DÉSIGNATION	UT	CODE	PPHT (€)
340.0003.34	TE EGAL F NOIR N 130 12X17	U	03837.2	5,56
340.0002.14	TE EGAL F NOIR N 130 15X21	U	03838.0	3,56
340.0003.62	TE EGAL F NOIR N 130 20X27	U	03839.8	6,03
340.0005.27	TE EGAL F NOIR N 130 26X34	U	03840.6	8,79
340.0009.64	TE EGAL F NOIR N 130 33X42	U	03841.4	16,06
340.0014.54	TE EGAL F NOIR N 130 40X49	U	03842.2	24,23
340.0021.12	TE EGAL F NOIR N 130 50X60	U	03843.0	35,20
340.0047.51	TE EGAL F NOIR N 130 66X76	U	03845.5	79,18



TE

FFF - Réduit - 130R - EN10242 - Noir



	DÉSIGNATION	UT	CODE	PPHT (€)
340.0003.91	TE REDUIT F NOIR N 130 20X15X20	U	03879.4	6,51
340.0005.16	TE REDUIT F NOIR N 130 26X15X26	U	03892.7	8,60
340.0005.62	TE REDUIT F NOIR N 130 26X20X26	U	03895.0	9,36
340.0008.44	TE REDUIT F NOIR N 130 33X15X33	U	03906.5	14,06
340.0009.15	TE REDUIT F NOIR N 130 33X20X33	U	03910.7	15,25
340.0010.12	TE REDUIT F NOIR N 130 33X26X33	U	03914.9	16,86
340.0011.40	TE REDUIT F NOIR N 130 40X15X40	U	03924.8	19,00
340.0012.08	TE REDUIT F NOIR N 130 40X20X40	U	03927.1	20,14

ACIER

RACCORDS FONTE MALLEABLE NOIR



TE

FFF - Réduit - 130R - EN10242 - Noir
- suite

	DÉSIGNATION	UT	CODE	PPHT (€)
340.0013.28	TE REDUIT F NOIR N 130 40X26X40	U	03932.1	22,14
340.0016.87	TE REDUIT F NOIR N 130 50X26X50	U	03950.3	28,12



MANCHON

FF - 270 - EN10242 - Noir



	DÉSIGNATION	UT	CODE	PPHT (€)
340.0002.31	MANCHON NOIR N 270 12X17	U	04407.3	3,85
340.0001.88	MANCHON NOIR N 270 15X21	U	04408.1	3,14
340.0002.42	MANCHON NOIR N 270 20X27	U	04409.9	4,04
340.0003.14	MANCHON NOIR N 270 26X34	U	04410.7	5,23
340.0005.16	MANCHON NOIR N 270 33X42	U	04411.5	8,60
340.0007.15	MANCHON NOIR N 270 40X49	U	04412.3	11,92
340.0010.78	MANCHON NOIR N 270 50X60	U	04413.1	17,96
340.0030.18	MANCHON NOIR N 270 66X76	U	04415.6	50,30



MANCHON

FF - 271 - EN10242 - Noir



	DÉSIGNATION	UT	CODE	PPHT (€)
340.0002.82	MANCHON NOIR N 271 15X21	U	04436.2	4,70
340.0003.62	MANCHON NOIR N 271 20X27	U	04437.0	6,03
340.0004.82	MANCHON NOIR N 271 26X34	U	04438.8	8,03



MAMELON

MM - 280 - EN10242 - Noir



	DÉSIGNATION	UT	CODE	PPHT (€)
340.0003.08	MAMELON NOIR N 280 12X17	U	04463.6	5,13
340.0001.60	MAMELON NOIR N 280 15X21	U	04464.4	2,66
340.0002.11	MAMELON NOIR N 280 20X27	U	04465.1	3,52
340.0002.93	MAMELON NOIR N 280 26X34	U	04466.9	4,89
340.0005.08	MAMELON NOIR N 280 33X42	U	04467.7	8,46
340.0006.01	MAMELON NOIR N 280 40X49	U	04468.5	10,02
340.0010.43	MAMELON NOIR N 280 50X60	U	04469.3	17,39
340.0019.04	MAMELON NOIR N 280 66X76	U	04471.9	31,73
340.0023.06	MAMELON NOIR N 280 80X90	U	04472.7	38,43

ACIER

RACCORDS FONTE MALLEABLE NOIR



REDUCTION

FF - Réduit - 240R - EN10242 - Noir



	DÉSIGNATION	UT	CODE	PPHT (€)
340.0002.88	MANCHON REDUIT FF NOIR N 240 15X12	U	04179.8	4,80
340.0003.11	MANCHON REDUIT FF NOIR N 240 20X15	U	04183.0	5,18
340.0003.62	MANCHON REDUIT FF NOIR N 240 26X20	U	04186.3	6,03
340.0006.50	MANCHON REDUIT FF NOIR N 240 33X26	U	04190.5	10,83
340.0010.21	MANCHON REDUIT FF NOIR N 240 40X20	U	04193.9	17,01
340.0007.90	MANCHON REDUIT FF NOIR N 240 40X26	U	04194.7	13,16
340.0008.55	MANCHON REDUIT FF NOIR N 240 40X33	U	04195.4	14,25
340.0015.16	MANCHON REDUIT FF NOIR N 240 50X26	U	04198.8	25,27
340.0013.76	MANCHON REDUIT FF NOIR N 240 50X33	U	04199.6	22,94
340.0012.91	MANCHON REDUIT FF NOIR N 240 50X40	U	04200.2	21,52



REDUCTION

MF - Réduit - 241R - EN10242 - Noir



	DÉSIGNATION	UT	CODE	PPHT (€)
340.0002.80	MAMELON REDUIT MF NOIR N 241 8X5	U	04238.2	4,66
340.0002.02	MAMELON REDUIT MF NOIR N 241 12X8	U	04240.8	3,37
340.0001.63	MAMELON REDUIT MF NOIR N 241 15X8	U	04242.4	2,71
340.0001.51	MAMELON REDUIT MF NOIR N 241 15X12	U	04243.2	2,52
340.0002.28	MAMELON REDUIT MF NOIR N 241 20X12	U	04246.5	3,80
340.0001.60	MAMELON REDUIT MF NOIR N 241 20X15	U	04247.3	2,66
340.0003.71	MAMELON REDUIT MF NOIR N 241 26X12	U	04250.7	6,18
340.0002.36	MAMELON REDUIT MF NOIR N 241 26X15	U	04251.5	3,94
340.0002.11	MAMELON REDUIT MF NOIR N 241 26X20	U	04252.3	3,52
340.0004.30	MAMELON REDUIT MF NOIR N 241 33X15	U	04253.1	7,17
340.0003.68	MAMELON REDUIT MF NOIR N 241 33X20	U	04254.9	6,13
340.0002.82	MAMELON REDUIT MF NOIR N 241 33X26	U	04255.6	4,70
340.0005.24	MAMELON REDUIT MF NOIR N 241 40X15	U	04258.0	8,74
340.0006.04	MAMELON REDUIT MF NOIR N 241 40X20	U	04259.8	10,07
340.0004.02	MAMELON REDUIT MF NOIR N 241 40X26	U	04260.6	6,70
340.0004.07	MAMELON REDUIT MF NOIR N 241 40X33	U	04261.4	6,79
340.0010.57	MAMELON REDUIT MF NOIR N 241 50X15	U	04263.0	17,62
340.0010.52	MAMELON REDUIT MF NOIR N 241 50X20	U	04264.8	17,53
340.0008.66	MAMELON REDUIT MF NOIR N 241 50X26	U	04265.5	14,44
340.0008.27	MAMELON REDUIT MF NOIR N 241 50X33	U	04266.3	13,78
340.0007.38	MAMELON REDUIT MF NOIR N 241 50X40	U	04267.1	12,30
340.0017.41	MAMELON REDUIT MF NOIR N 241 66X26	U	04272.1	29,02
340.0014.39	MAMELON REDUIT MF NOIR N 241 66X50	U	04275.4	23,99
340.0018.84	MAMELON REDUIT MF NOIR N 241 80X50	U	04279.6	31,40
340.0021.26	MAMELON REDUIT MF NOIR N 241 80X66	U	04281.2	35,44
340.0038.25	MAMELON REDUIT MF NOIR N 241 102X80	U	22199.4	63,75

ACIER

RACCORDS FONTE MALLEABLE NOIR



REDUCTION

MM - Réduit - 245R - EN10242 - Noir



	DÉSIGNATION	UT	CODE	PPHT (€)
340.0003.71	MAMELON REDUIT MM NOIR N 245 15X12	U	04326.5	6,18
340.0003.37	MAMELON REDUIT MM NOIR N 245 20X15	U	04329.9	5,61
340.0006.50	MAMELON REDUIT MM NOIR N 245 26X15	U	04331.5	10,83
340.0003.71	MAMELON REDUIT MM NOIR N 245 26X20	U	04332.3	6,18
340.0008.69	MAMELON REDUIT MM NOIR N 245 33X20	U	04335.6	14,49
340.0006.10	MAMELON REDUIT MM NOIR N 245 33X26	U	04336.4	10,17
340.0013.63	MAMELON REDUIT MM NOIR N 245 40X26	U	04339.8	22,71
340.0007.33	MAMELON REDUIT MM NOIR N 245 40X33	U	04338.0	12,21
340.0015.47	MAMELON REDUIT MM NOIR N 245 50X33	U	04341.4	25,79
340.0014.02	MAMELON REDUIT MM NOIR N 245 50X40	U	04342.2	23,37
340.0050.89	MAMELON REDUIT MM NOIR N 245 80X66	U	0948F.2	84,81



REDUCTION

FM - Réduit - 246R - EN10242 - Noir



	DÉSIGNATION	UT	CODE	PPHT (€)
340.0005.05	MANCHON REDUIT FM NOIR N 246 26X15	U	04374.5	8,41
340.0005.16	MANCHON REDUIT FM NOIR N 246 26X20	U	04375.2	8,60
340.0009.38	MANCHON REDUIT FM NOIR N 246 33X20	U	04377.8	15,63
340.0006.04	MANCHON REDUIT FM NOIR N 246 33X26	U	04378.6	10,07
340.0011.23	MANCHON REDUIT FM NOIR N 246 40X26	U	04381.0	18,72
340.0009.77	MANCHON REDUIT FM NOIR N 246 40X33	U	04382.8	16,29
340.0015.70	MANCHON REDUIT FM NOIR N 246 50X33	U	04384.4	26,17
340.0016.45	MANCHON REDUIT FM NOIR N 246 50X40	U	04385.1	27,41
340.0003.08	MANCHON REDUIT FM NOIR N 246 15X12	U	04370.3	5,13
340.0003.25	MANCHON REDUIT FM NOIR N 246 20X15	U	04372.9	5,42



BOUCHON

Mâle - 290 - EN10242 - Noir



	DÉSIGNATION	UT	CODE	PPHT (€)
340.0001.34	BOUCHON MALE NOIR N 290 12X17	U	04519.5	2,23
340.0001.31	BOUCHON MALE NOIR N 290 15X21	U	04520.3	2,19
340.0001.74	BOUCHON MALE NOIR N 290 20X27	U	04521.1	2,90
340.0001.97	BOUCHON MALE NOIR N 290 26X34	U	04522.9	3,28
340.0003.50	BOUCHON MALE NOIR N 290 33X42	U	04523.7	5,84
340.0004.48	BOUCHON MALE NOIR N 290 40X49	U	04524.5	7,46
340.0007.75	BOUCHON MALE NOIR N 290 50X60	U	04525.2	12,92
340.0016.59	BOUCHON MALE NOIR N 290 66X76	U	04527.8	27,65

ACIER

RACCORDS FONTE MALLEABLE NOIR



BOUCHON

Femelle - 300 - EN10242 - Noir

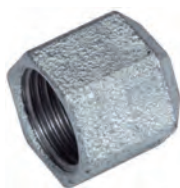

	DÉSIGNATION	UT	CODE	PPHT (€)
340.0001.71	BOUCHON FEMELLE NOIR N 300 12X17	U	04575.7	2,85
340.0002.02	BOUCHON FEMELLE NOIR N 300 15X21	U	04576.5	3,37
340.0002.42	BOUCHON FEMELLE NOIR N 300 20X27	U	04577.3	4,04
340.0002.91	BOUCHON FEMELLE NOIR N 300 26X34	U	04578.1	4,85
340.0004.42	BOUCHON FEMELLE NOIR N 300 33X42	U	04579.9	7,36
340.0005.44	BOUCHON FEMELLE NOIR N 300 40X49	U	04580.7	9,07
340.0009.98	BOUCHON FEMELLE NOIR N 300 50X60	U	04581.5	16,63



RACCORD UNION

MF - 331 - A joint plat - EN10242 - Noir



	DÉSIGNATION	UT	CODE	PPHT (€)
340.0007.70	UNION MF NOIR N 331 GAZ A JP 15X21	U	04660.7	12,83
340.0008.41	UNION MF NOIR N 331 GAZ A JP 20X27	U	04661.5	14,01
340.0010.23	UNION MF NOIR N 331 GAZ A JP 26X34	U	04662.3	17,05
340.0017.44	UNION MF NOIR N 331 GAZ A JP 33X42	U	04663.1	29,07
340.0034.06	UNION MF NOIR N 331 GAZ A JP 50X60	U	04665.6	56,76



RACCORD UNION

FF - 340 - EN10242 - Noir



	DÉSIGNATION	UT	CODE	PPHT (€)
340.0010.52	UNION FF NOIR N 340 12X17	U	04687.0	17,53
340.0007.93	UNION FF NOIR N 340 15X21	U	04688.8	13,21
340.0008.89	UNION FF NOIR N 340 20X27	U	04689.6	14,82
340.0010.34	UNION FF NOIR N 340 26X34	U	04690.4	17,24
340.0017.10	UNION FF NOIR N 340 33X42	U	04691.2	28,50
340.0020.12	UNION FF NOIR N 340 40X49	U	04692.0	33,54
340.0032.80	UNION FF NOIR N 340 50X60	U	04693.8	54,67



RACCORD UNION

MF - 341 - EN10242 - Noir



	DÉSIGNATION	UT	CODE	PPHT (€)
340.0009.23	UNION MF NOIR N 341 12X17	U	04715.9	15,39
340.0007.78	UNION MF NOIR N 341 15X21	U	04716.7	12,97
340.0009.38	UNION MF NOIR N 341 20X27	U	04717.5	15,63
340.0011.60	UNION MF NOIR N 341 26X34	U	04718.3	19,33

ACIER

RACCORDS FONTE MALLEABLE NOIR



RACCORD UNION

MF - 341 - EN10242 - Noir
- suite

	DÉSIGNATION	UT	CODE	PPHT (€)
340.0018.32	UNION MF NOIR N 341 33X42	U	04719.1	30,54
340.0023.34	UNION MF NOIR N 341 40X49	U	04720.9	38,90
340.0037.31	UNION MF NOIR N 341 50X60	U	04721.7	62,18
340.0081.37	UNION MF NOIR N 341 66X76	U	04723.3	135,61

RACCORDS PETROLE



TE

AE250B - Sans soudure - NFA 49281



	DÉSIGNATION	UT	CODE	PPHT (€)
345.0019.23	TE A SOUDER EN10253-1 33,7X2,6	U	04672.2	32,05
345.0023.66	TE A SOUDER EN10253-1 42,4X2,6	U	04680.5	39,43
345.0025.14	TE A SOUDER EN10253-1 48,3X2,6	U	04683.9	41,90
345.0030.41	TE A SOUDER EN10253-1 60,3X2,9	U	04684.7	50,69
345.0046.35	TE A SOUDER EN10253-1 76,1X2,9	U	04697.9	77,25



TE P235GH

Té à souder ATG



	DÉSIGNATION	UT	CODE	PPHT (€)
000.0018.69	TE EN10253-2 P235GH A SOUDER ATG 60.3X3.6	U	317CK.3	18,69
000.0026.58	TE EN10253-2 P235GH A SOUDER ATG 88.9X4.0	U	317CN.7	26,58

TUBES ACIER ELECTROZINGUE

TUBE ACIER CARBONE ELECTROZINGUE
SUDOXPRESS

Type C1459 - Mètre



	DÉSIGNATION	UT	CODE	PPHT (€)
351.0005.98	TUBE AC.ELEC.ZING.EXT. 22X1.5 6205177	M	208WC.6	7,04
351.0004.48	TUBE AC.ELEC.ZING.EXT. 18X1.2 6205166	M	208WB.8	5,27
351.0008.44	TUBE AC.ELEC.ZING.EXT. 28X1.5 6205188	M	208WD.4	9,93

ACIER

TUBES ACIER ELECTROZINGUE



TUBE ACIER CARBONE ELECTROZINGUE SUDOPRESS

Type C1459 - Mètre
- suite



	DÉSIGNATION	UT	CODE	PPHT (€)
351.0011.02	TUBE AC.ELEC.ZING.EXT. 35X1.5 6205199	M	208WE.1	12,97
351.0040.43	TUBE AC.ELEC.ZING.EXT. 76.1X2.0 6204803	M	208W6.9	47,56
351.0012.58	TUBE AC.ELEC.ZING.EXT. 42X1.5 6205201	M	208WF.9	14,80
351.0019.70	TUBE AC.ELEC.ZING.EXT. 54X1.5 6205221	M	208WG.7	23,18

RACCORDS ACIER ELECTROZINGUE A SERTIR



COUDE XPRESS ACIER EZ

Coude 90° MF - Type C1411 - Joint EPDM



	DÉSIGNATION	UT	CODE	PPHT (€)
351.0005.36	COUDE 90 MF EL.ZING. 18 6201646	U	1727B.6	6,30
351.0005.99	COUDE 90 MF EL.ZING. 22 6201657	U	1730B.1	7,05
351.0008.24	COUDE 90 MF EL.ZING. 28 6201668	U	1733B.8	9,70
351.0020.49	COUDE 90 MF EL.ZING. 35 6201679	U	1736B.5	24,11
351.0032.79	COUDE 90 MF EL.ZING. 42 6201681	U	1739B.2	38,58
351.0039.28	COUDE 90 MF EL.ZING. 54 6201690	U	9118B.6	46,21



COUDE XPRESS ACIER EZ

Coude 90° FF - Type C1408 - Joint EPDM



	DÉSIGNATION	UT	CODE	PPHT (€)
351.0005.36	COUDE 90 FF EL.ZING. 18 6201569	U	1879B.2	6,30
351.0005.99	COUDE 90 FF EL.ZING. 22 6201571	U	1882B.7	7,05
351.0008.24	COUDE 90 FF EL.ZING. 28 6201580	U	1885B.4	9,70
351.0020.49	COUDE 90 FF EL.ZING. 35 6201591	U	1888B.1	24,11
351.0032.79	COUDE 90 FF EL.ZING. 42 6201602	U	1891B.6	38,58
351.0040.13	COUDE 90 FF EL.ZING. 54 6201613	U	5232C.3	47,21
351.0095.14	COUDE 90 FF EL.ZING. 76,1 6208004	U	6392A.5	158,57



COUDE XPRESS ACIER EZ

Coude 45° MF - Type C1412 - Joint EPDM



	DÉSIGNATION	UT	CODE	PPHT (€)
351.0005.04	COUDE 45 MF EL.ZING.18 6201789	U	1763B.1	5,93

ACIER

RACCORDS ACIER ELECTROZINGUE A SERTIR



COUDE XPRESS ACIER EZ

Coude 45° MF - Type C1412 - Joint EPDM
- suite



	DÉSIGNATION	UT	CODE	PPHT (€)
351.0005.47	COUDE 45 MF EL.ZING.22 6201791	U	1766B.8	6,43
351.0008.30	COUDE 45 MF EL.ZING.28 6201800	U	1769B.5	9,77
351.0014.98	COUDE 45 MF EL.ZING.35 6201811	U	1772B.0	17,62
351.0019.92	COUDE 45 MF EL.ZING.42 6201822	U	1775B.7	23,44
351.0022.81	COUDE 45 MF EL.ZING.54 6201833	U	9113B.1	26,83



COUDE XPRESS ACIER EZ

Coude 45° FF - Type C1413 - Joint EPDM



	DÉSIGNATION	UT	CODE	PPHT (€)
351.0005.75	COUDE 45 FF EL.ZING.18 6201712	U	1745B.4	6,76
351.0006.05	COUDE 45 FF EL.ZING.22 6201723	U	1748B.1	7,12
351.0008.30	COUDE 45 FF EL.ZING.28 6201734	U	1751B.5	9,77
351.0016.18	COUDE 45 FF EL.ZING.35 6201745	U	1754B.2	19,04
351.0020.36	COUDE 45 FF EL.ZING.42 6201756	U	1757B.9	23,95
351.0022.94	COUDE 45 FF EL.ZING.54 6201767	U	9111B.3	26,99



TE XPRESS ACIER EZ

Té égal FFF - Type C1414 - Joint EPDM



	DÉSIGNATION	UT	CODE	PPHT (€)
351.0009.42	TE EGAL FFF EL.ZING.18 6202504	U	1823B.9	11,08
351.0010.12	TE EGAL FFF EL.ZING.22 6202515	U	1826B.6	11,90
351.0013.56	TE EGAL FFF EL.ZING.28 6202526	U	1829B.3	15,95
351.0021.08	TE EGAL FFF EL.ZING.35 6202537	U	1832B.8	24,80
351.0031.14	TE EGAL FFF EL.ZING.42 6202548	U	1835B.5	36,64
351.0037.34	TE EGAL FFF EL.ZING.54 6202559	U	9125B.7	43,93



TE XPRESS ACIER EZ

Té réduit FFF - Type C1415 - Joint EPDM



	DÉSIGNATION	UT	CODE	PPHT (€)
351.0010.12	TE REDUIT FFF EL.ZING.22-18-22 6202614	U	1844B.4	11,90
351.0013.84	TE REDUIT FFF EL.ZING.28-18-28 6202636	U	1850B.5	16,28
351.0014.57	TE REDUIT FFF EL.ZING.28-22-28 6202647	U	1853B.2	17,14
351.0020.82	TE REDUIT FFF EL.ZING.35-18-35 6202669	U	1859B.6	24,49
351.0021.24	TE REDUIT FFF EL.ZING.35-22-35 6202671	U	1862B.1	24,99

ACIER

RACCORDS ACIER ELECTROZINGUE A SERTIR



TE XPRESS ACIER EZ

Té réduit FFF - Type C1415 - Joint EPDM
- suite



	DÉSIGNATION	UT	CODE	PPHT (€)
351.0021.52	TE REDUIT FFF EL.ZING.35-28-35 6202680	U	1865B.8	25,32
351.0028.42	TE REDUIT FFF EL.ZING.42-22-42 6202691	U	1868B.5	33,43
351.0029.50	TE REDUIT FFF EL.ZING.42-28-42 6202702	U	1871B.0	34,70
351.0028.82	TE REDUIT FFF EL.ZING.42-35-42 6202713	U	1874B.7	33,91
351.0033.90	TE REDUIT FFF EL.ZING.54-22-54 6202724	U	1877B.4	39,88
351.0034.55	TE REDUIT FFF EL.ZING.54-28-54 6202735	U	1880B.9	40,65
351.0035.64	TE REDUIT FFF EL.ZING.54-35-54 6202746	U	1883B.6	41,93
351.0037.34	TE REDUIT FFF EL.ZING.54-42-54 6202757	U	1886B.3	43,93
351.0271.61	TE REDUIT FFF EL.ZING.76,1-35-76,1 6207069	U	1216J.8	319,54
351.0277.52	TE REDUIT FFF EL.ZING.76,1-42-76,1 6207071	U	12170.7	326,50



MANCHON XPRESS ACIER EZ

Manchon FF - Type C1401 - Joint EPDM



	DÉSIGNATION	UT	CODE	PPHT (€)
351.0003.17	MANCHON COURT EL.ZING.18 6201371	U	1861B.2	3,73
351.0003.67	MANCHON COURT EL.ZING.22 6201382	U	1864B.9	4,32
351.0004.84	MANCHON COURT EL.ZING.28 6201393	U	1867B.6	5,70
351.0008.14	MANCHON COURT EL.ZING.35 6201404	U	1870B.1	9,58
351.0010.88	MANCHON COURT EL.ZING.42 6201415	U	1873B.8	12,80
351.0012.81	MANCHON COURT EL.ZING.54 6201426	U	9119B.5	15,07
351.0060.65	MANCHON COURT EL.ZING.76,1 6206200	U	68305.2	71,35



REDUCTION XPRESS ACIER EZ

Réduction MF - Type C1407 - Joint EPDM



	DÉSIGNATION	UT	CODE	PPHT (€)
351.0003.56	REDUCTION CONCENT.MF EL.ZING.22X18 6202163	U	1895B.2	4,19
351.0004.65	REDUCTION CONCENT.MF EL.ZING.28X18 6202185	U	1731B.0	5,47
351.0004.73	REDUCTION CONCENT.MF EL.ZING.28X22 6202196	U	1737B.4	5,57
351.0005.53	REDUCTION CONCENT.MF EL.ZING.35X22 6202207	U	1740B.9	6,51
351.0005.60	REDUCTION CONCENT.MF EL.ZING.35X28 6202218	U	5610A.3	6,59
351.0016.12	REDUCTION CONCENT.MF EL.ZING.42X22 6206651	U	7239J.9	18,96
351.0017.62	REDUCTION CONCENT.MF EL.ZING.42X28 6206662	U	7239J.8	20,73
351.0017.88	REDUCTION CONCENT.MF EL.ZING.42X35 6202229	U	1746B.3	21,04
351.0028.09	REDUCTION CONCENT.MF EL.ZING.54X35 6206684	U	5745I.0	33,05
351.0028.13	REDUCTION CONCENT.MF EL.ZING.54X42 6202251	U	9124B.8	33,09
351.0068.72	REDUCTION CONCENT.MF EL.ZING.76X42 6206387	U	68202.1	80,85
351.0085.10	REDUCTION CONCENT.MF EL.ZING.76X54 6206398	U	68217.9	100,12
351.0091.07	REDUCTION CONCENT.MF EL.ZING.89X76 6206411	U	68235.1	107,14

ACIER

RACCORDS ACIER ELECTROZINGUE A SERTIR



BOUCHON XPRESS ACIER EZ

Bouchon à sertir F - Type C1429 - Joint EPDM



	DÉSIGNATION	UT	CODE	PPHT (€)
351.0007.93	BOUCHON OBTURATION EL.ZING.18 6202966	U	1791B.7	9,33
351.0012.72	BOUCHON OBTURATION EL.ZING.28 6202988	U	1797B.1	14,97
351.0014.21	BOUCHON OBTURATION EL.ZING.35 6202999	U	1800B.6	16,72



BRIDE XPRESS ACIER EZ

Bride plate bout lisse - Type C1426 - PN16



	DÉSIGNATION	UT	CODE	PPHT (€)
351.0232.99	BRIDE PLATE PN 10/16 76,1 6206596	U	20140.0	274,11

RACCORDS ACIER ELECTROZINGUE A SERTIR ET A VISSER



TE XPRESS ACIER EZ

Té mixte taraudé FFF - Type C1418 - Joint EPDM



	DÉSIGNATION	UT	CODE	PPHT (€)
351.0012.51	TE MIXTE TAR.EL.ZING.18-1/2-18 6202823	U	1752B.4	14,72
351.0013.74	TE MIXTE TAR.EL.ZING.22-1/2-22 6202834	U	1755B.1	16,16
351.0016.68	TE MIXTE TAR.EL.ZING.22-3/4-22 6206706	U	4470F.0	19,62
351.0015.94	TE MIXTE TAR.EL.ZING.28-1/2-28 6202845	U	1758B.8	18,75
351.0017.32	TE MIXTE TAR.EL.ZING.28-3/4-28 6207181	U	4470G.8	20,38
351.0021.83	TE MIXTE TAR.EL.ZING.35-1/2-35 6202856	U	1761B.3	25,68
351.0028.02	TE MIXTE TAR.EL.ZING.35-3/4-35 6207102	U	4470H.6	32,97
351.0033.90	TE MIXTE TAR.EL.ZING.42-1/2-42 6202867	U	1764B.0	39,88
351.0039.88	TE MIXTE TAR.EL.ZING.42-3/4-42 6207113	U	4470I.4	46,92
351.0037.34	TE MIXTE TAR.EL.ZING.54-1/2-54 6202878	U	1767B.7	43,93
351.0043.83	TE MIXTE TAR.EL.ZING.54-3/4-54 6207124	U	46540.1	51,57
351.0164.07	TE MIXTE TAR.EL.ZING.76,1-RP3/4 6206508	U	6817B.3	193,02



RACCORD XPRESS ACIER EZ

Raccord droit FF - Type C1402 - Joint EPDM



	DÉSIGNATION	UT	CODE	PPHT (€)
351.0010.00	RACCORD MIXTE TARAUDE 18X1/2 EZ 6202383	U	1782B.8	11,77
351.0011.96	RACCORD MIXTE TARAUDE 22X1/2 EZ 6340202	U	5949D.5	19,94
351.0011.73	RACCORD MIXTE TARAUDE 22X3/4 EZ 6202405	U	0048J.4	13,80

ACIER

RACCORDS ACIER ELECTROZINGUE A SERTIR ET A VISSER



RACCORD XPRESS ACIER EZ
Raccord droit FF - Type C1402 - Joint EPDM
- suite



	DÉSIGNATION	UT	CODE	PPHT (€)
351.0014.98	RACCORD MIXTE TARAUDE 28X1 EZ 6202416	U	1785B.5	17,62
351.0016.68	RACCORD MIXTE TARAUDE 28X3/4 EZ 6209830	U	2443B.7	19,62



RACCORD XPRESS ACIER EZ
Raccord droit MF - Type C1405 - Joint EPDM



	DÉSIGNATION	UT	CODE	PPHT (€)
351.0010.18	RACCORD MIXTE MALE EL.ZING.18-1/2 6202295	U	1805B.1	11,98
351.0011.73	RACCORD MIXTE MALE EL.ZING.18-3/4 6202306	U	9121B.1	13,80
351.0009.89	RACCORD MIXTE MALE EL.ZING.22-1/2 6206717	U	2969S.9	14,13
351.0011.73	RACCORD MIXTE MALE EL.ZING.22-3/4 6202317	U	1808B.8	13,80
351.0014.98	RACCORD MIXTE MALE EL.ZING.28-1 6202328	U	1811B.3	17,62
351.0019.17	RACCORD MIXTE MALE EL.ZING.35-1 1/4 6202339	U	1814B.0	22,55
351.0021.44	RACCORD MIXTE MALE EL.ZING.42-1 1/2 6202341	U	1817B.7	25,22
351.0033.18	RACCORD MIXTE MALE EL.ZING.54-2 6202350	U	4185B.5	39,04
351.0062.03	RACCORD MIXTE MALE EL.ZING.76,1-21/2 6204781	U	1212C.6	72,98



RACCORD UNION XPRESS ACIER EZ
Raccord écrou libre F - Type C1446 - Joint EPDM



	DÉSIGNATION	UT	CODE	PPHT (€)
351.0013.69	RACCORD A SERTIR ECR.LIBRE 22-1 6340554	U	12226.7	14,26
351.0016.87	RACCORD A SERTIR ECR.LIBRE 28-11/4 6340565	U	1222A.8	19,85
351.0022.94	RACCORD A SERTIR ECR.LIBRE 35-11/2 6340576	U	12230.9	26,99



RACCORD UNION XPRESS ACIER EZ
Raccord union FF - Type C1444 - Joint EPDM



	DÉSIGNATION	UT	CODE	PPHT (€)
351.0018.39	RACCORD UN.TAR.FEM.EL.ZING.18-1/2 6208917	U	5550L.9	21,63
351.0036.07	RACCORD UN.TAR.FEM.EL.ZING.28-1 6208939	U	5551C.6	42,43
351.0051.89	RACCORD UN.TAR.FEM.EL.ZING.35-11/4 6208941	U	20596.1	61,05
351.0075.17	RACCORD UN.TAR.FEM.EL.ZING.42-11/2 6208950	U	5551E.1	88,43
351.0119.56	RACCORD UN.TAR.FEM.EL.ZING.54-2 6208961	U	52011.7	199,27

ACIER

RACCORDS ACIER ELECTROZINGUE A SERTIR ET A VISSER



RACCORD UNION XPRESS ACIER EZ
Raccord union MF - Type C1435 - Joint EPDM



	DÉSIGNATION	UT	CODE	PPHT (€)
351.0017.29	RACCORD A SERT.Z3416E1 CARB.M 18-1/2 6207036	U	1213C.5	23,05
351.0069.93	RACCORD UNION FIL.MALE 42X11/2 6207234	U	72586.9	82,27
351.0161.21	RACCORD UNION FIL.MALE 54X2 6207245	U	62321.8	189,66
351.0020.77	RACCORD UNION FIL.MALE 22X3/4 6207201	U	7369J.0	24,43
351.0033.98	RACCORD UNION FIL.MALE 28X1 6207212	U	73691.1	39,98
351.0046.30	RACCORD UNION FIL.MALE 35.11/4 6207223	U	7369K.8	54,47

RACCORDS DE REPARATION ACIER



GAMME ORIGINAL

Collier de réparation - Long DSL - Pour tube acier



	DÉSIGNATION	UT	CODE	PPHT (€)
000.0026.80	COLLIER REP.LONG DSL 1/2 012522801	U	6944L.2	43,23
000.0027.71	COLLIER REP.LONG DSL 3/4 012522802	U	85469.5	44,70
000.0031.04	COLLIER REP.LONG DSL 1" 012522803	U	85472.9	50,07
000.0036.94	COLLIER REP.LONG DSL 1"1/2 012522805	U	85501.5	59,58
000.0034.76	COLLIER REP.LONG DSL 1"1/4 012522804	U	85478.6	56,07
000.0044.07	COLLIER REP.LONG DSL 2" 012522806	U	85504.9	71,08
000.0067.46	COLLIER REP.LONG DSL 2"1/2 012522807	U	6945C.9	108,80



GAMME UNIFIX

Collier de réparation - Mini - 1 boulon



	DÉSIGNATION	UT	CODE	PPHT (€)
000.0010.17	COLLIER REP.UNIFIX MINI 21-25 500102102506	U	71725.6	16,40
000.0010.47	COLLIER REP.UNIFIX MINI 26-30 500102603006	U	71763.7	16,88
000.0010.77	COLLIER REP.UNIFIX MINI 29-33 500102903306	U	6752F.4	17,37
000.0010.77	COLLIER REP.UNIFIX MINI 33-37 500103303706	U	45161.7	17,37
000.0011.07	COLLIER REP.UNIFIX MINI 38-42 500103804206	U	45197.1	17,85
000.0011.25	COLLIER REP.UNIFIX MINI 42-45 500104204506	U	71980.7	18,15
000.0012.16	COLLIER REP.UNIFIX MINI 48-51 500104805106	U	71729.8	19,61
000.0016.85	COLLIER REP.UNIFIX MINI 50-54 500105005406	U	6754J.5	27,17
000.0016.85	COLLIER REP.UNIFIX MINI 55-58 500105505806	U	6754L.1	27,17
000.0017.65	COLLIER REP.UNIFIX MINI 60-64 500106006406	U	45224.3	28,46
000.0018.23	COLLIER REP.UNIFIX MINI 69-73 500106907306	U	6755C.8	29,41
000.0018.63	COLLIER REP.UNIFIX MINI 74-80 500107408006	U	6755D.6	30,05

ACIER

RACCORDS DE REPARATION ACIER



ROBINETTERIE, COMPTEURS & RACCORDS

COLLIER DE REPARATION

A jonction définitive - Type B - 3

Tirants - 1403 - Longueur 200 mm



	DÉSIGNATION	UT	CODE	PPHT (€)	ECOPART (€)
430.0220.90	COLLIER REP.CR1403 TYP.B 3T.60/68 1403060	U	75471.3	294,61	0,08
430.0222.51	COLLIER REP.CR1403 TYP.B 3T.68/78 1403068	U	75496.0	296,76	0,08
430.0233.29	COLLIER REP.CR1403 TYP.B 3T.88/98 1403088	U	90487.0	311,13	0,08
430.0249.80	COLLIER REP.CR1403 TYP.B 3T.108/118 1403108	U	8093B.7	333,14	0,08

Pour plus d'infos,
consultez
le CAHIER TECHNIQUE
page 14

**VOTRE
ESPACE PRO,
LA CLÉ DE TOUS
VOS SUCCÈS !**

MON ESPACE PRO
www.richardson.fr



Rendez-vous vers
votre espace pro



INOX

TUBES INOX



TUBE ACIER INOXYDABLE SUDOXPRESS

Type R2751 - 1.4301 (AISI 304) - Mètre



	DÉSIGNATION	UT	CODE	PPHT (€)
100.0026.83	TUBE INOX SUDOXPRESS 1.4301 76,1X2 HB 6195079	M	304A9.6	74,52
100.0038.66	TUBE INOX SUDOXPRESS 1.4301 88,9X2 HB 6195081	M	304AA.3	96,65



TUBE ACIER INOXYDABLE SUDOXPRESS

Type R2751 - 1.4301 (AISI 304) - Mini-Fardeau

/ Mètre



	DÉSIGNATION	UT	CODE	PPHT (€)
100.0003.71	TUBE INOX SUDOXPRESS 1.4301 18X1.0 HB 6196003	M	210GU.7	10,31
100.0004.95	TUBE INOX SUDOXPRESS 1.4301 22X1.2 HB 6196014	M	210GH.1	13,75
100.0006.15	TUBE INOX SUDOXPRESS 1.4301 28X1.2 HB 6196025	M	210GJ.8	17,09
100.0009.97	TUBE INOX SUDOXPRESS 1.4301 35X1.5 HB 6196036	M	210GR.4	27,69



TUBE ACIER INOXYDABLE SUDOXPRESS

Type R2750 - 1.4401 (AISI 316) - Mini-fardeau

/ Mètre



	DÉSIGNATION	UT	CODE	PPHT (€)
100.0005.99	TUBE INOX SUDOXPRESS 316 - 18X1.0 HB 6192318	M	210GQ.6	16,64
100.0007.98	TUBE INOX SUDOXPRESS 316 - 22X1.2 HB 6192329	M	210CS.6	22,18
100.0009.86	TUBE INOX SUDOXPRESS 316 - 28X1.2 HB 6192331	M	210GS.2	27,40
100.0014.53	TUBE INOX SUDOXPRESS 316 - 35X1.5 HB 6192340	M	210CP.2	40,36
100.0017.42	TUBE INOX SUDOXPRESS 316 42X1.5 6M HB 6192351	M	210CQ.0	48,39
100.0022.23	TUBE INOX SUDOXPRESS 316 - 54X1.5 HB 6192362	M	210CN.4	61,75
100.0046.32	TUBE INOX SUDOXPRESS 316 - 76.1X2 HB 6192373	M	236SQ.5	128,68

RACCORDS INOX A SERTIR



BRIDE XPRESS ACIER INOX

Bride plate à bout lisse - Type R2726



	DÉSIGNATION	UT	CODE	PPHT (€)
105.0102.57	BRIDE BOUT LISS.X7500B 65X76.1 6204121	U	6948G.7	320,53
105.0121.86	BRIDE BOUT LISS.X7500B 80X88.9 6204132	U	6948J.2	380,80

Le PPHT comprend l'ecopart (€)

INOX

RACCORDS INOX A SERTIR



COUDE XPRESS ACIER INOX

Coude 45° FF - Type R2713



	DÉSIGNATION	UT	CODE	PPHT (€)
101.0007.00	COUDE 45 FEMELLE X7041 D.18 6190052	U	6982E.8	18,41
101.0008.12	COUDE 45 FEMELLE X7041 D.22 6190063	U	6982F.6	21,37
101.0009.45	COUDE 45 FEMELLE X7041 D.28 6190074	U	6982H.2	24,87
101.0011.08	COUDE 45 FEMELLE X7041 D.35 6190085	U	6982J.9	29,16
101.0017.86	COUDE 45 FEMELLE X7041 D.42 6190096	U	6982K.7	47,01
101.0023.18	COUDE 45 FEMELLE X7041 D.54 6190107	U	6982L.5	61,00
105.0055.23	COUDE 45 FEMELLE X7041 D.76.1 6230061	U	69838.1	172,60
105.0066.87	COUDE 45 FEMELLE X7041 D.88.9 6230070	U	6983A.6	208,98



COUDE XPRESS ACIER INOX

Coude 45° MF - Type R2712



	DÉSIGNATION	UT	CODE	PPHT (€)
101.0006.82	COUDE 45 MALE-FEM.X7040 D.18 6190129	U	6983E.7	17,95
101.0007.85	COUDE 45 MALE-FEM.X7040 D.22 6190131	U	6983G.3	20,66
101.0009.21	COUDE 45 MALE-FEM.X7040 D.28 6190140	U	6983H.1	24,23
101.0010.50	COUDE 45 MALE-FEM.X7040 D.35 6190151	U	6983K.6	27,62
101.0016.86	COUDE 45 MALE-FEM.X7040 D.42 6190162	U	6983L.4	44,38
101.0021.99	COUDE 45 MALE-FEM.X7040 D.54 6190173	U	6984A.5	57,87
105.0053.08	COUDE 45 MALE-FEM.X7040 D.76.1 6230092	U	6984C.1	165,88



COUDE XPRESS ACIER INOX

Coude 90° FF - Type R2708



	DÉSIGNATION	UT	CODE	PPHT (€)
101.0005.51	COUDE 90 FEMELLE X7002A D.18 6190217	U	6984K.5	14,51
101.0006.74	COUDE 90 FEMELLE X7002A D.22 6190228	U	6984L.3	17,73
101.0008.50	COUDE 90 FEMELLE X7002A D.28 6190239	U	69852.2	22,37
101.0014.90	COUDE 90 FEMELLE X7002A D.35 6190241	U	69856.3	39,21
101.0024.23	COUDE 90 FEMELLE X7002A D.42 6190250	U	69857.1	63,76
101.0036.59	COUDE 90 FEMELLE X7002A D.54 6190261	U	6985A.4	96,28
105.0058.83	COUDE 90 FEMELLE X7002A D.76.1 6230004	U	6985C.0	183,83
105.0073.61	COUDE 90 FEMELLE X7002A D.88.9 6230015	U	6985D.8	230,04

INOX

RACCORDS INOX A SERTIR



COUDE XPRESS ACIER INOX

Coude 90° MF - Type R2711 - X7001A



	DÉSIGNATION	UT	CODE	PPHT (€)
101.0005.38	COUDE 90 MALE-FEM.X7001A D.18 6190351	U	6985I.7	14,17
101.0006.55	COUDE 90 MALE-FEM.X7001A D.22 6190360	U	6985J.6	17,25
101.0008.17	COUDE 90 MALE-FEM.X7001A D.28 6190371	U	6985K.4	21,49
101.0013.13	COUDE 90 MALE-FEM.X7001A D.35 6190382	U	69863.9	34,54
101.0021.28	COUDE 90 MALE-FEM.X7001A D.42 6190393	U	69865.4	56,00
101.0030.60	COUDE 90 MALE-FEM.X7001A D.54 6190404	U	69867.0	80,52
105.0062.25	COUDE 90 MALE-FEM.X7001A D.76.1 6230037	U	6986C.9	194,54



TE XPRESS ACIER INOX

Té égal FFF - Type R2714



	DÉSIGNATION	UT	CODE	PPHT (€)
101.0008.97	TE EGAL FEMELLE X7130 D.18 6191372	U	6989E.1	23,60
101.0009.67	TE EGAL FEMELLE X7130 D.22 6191405	U	6989F.9	25,45
101.0011.32	TE EGAL FEMELLE X7130 D.28 6191449	U	6989H.5	29,80
101.0014.36	TE EGAL FEMELLE X7130 D.35 6191493	U	6989I.3	37,78
101.0020.38	TE EGAL FEMELLE X7130 D.42 6191537	U	6989J.2	53,62
101.0024.33	TE EGAL FEMELLE X7130 D.54 6191581	U	6989K.0	64,02
105.0105.95	TE EGAL FEMELLE X7130 D.76.1 6204319	U	9060X.1	331,10
105.0115.91	TE EGAL FEMELLE X7130 D.88.9 6204321	U	9061I.5	362,21



TE XPRESS ACIER INOX

Té Réduit FFF - Type R2715



	DÉSIGNATION	UT	CODE	PPHT (€)
101.0008.56	TE REDUIT XR130R FEMELLE 22-18-22 6191394	U	6977I.4	22,53
101.0010.32	TE REDUIT XR130R FEMELLE 28-18-28 6191427	U	6977H.9	27,15
101.0010.85	TE REDUIT FEMELLE 28-22-28 XR130R 6191438	U	6977A.4	28,54
101.0012.91	TE REDUIT XR130R FEMELLE 35-22-35 6191471	U	6977F.3	33,98
101.0013.47	TE REDUIT XR130R FEMELLE 35-28-35 6191482	U	6977H.9	35,45
101.0018.49	TE REDUIT XR130R FEMELLE 42-22-42 6191504	U	6977I.7	48,66
101.0019.11	TE REDUIT XR130R FEMELLE 42-28-42 6191515	U	6977K.4	50,29
101.0019.70	TE REDUIT XR130R FEMELLE 42-35-42 6191526	U	6977L.2	51,85
101.0020.92	TE REDUIT 54X22X54 6191548	U	9326S.2	55,06
101.0021.52	TE REDUIT XR130R FEMELLE 54-28-54 6191559	U	69783.9	56,64
101.0022.25	TE REDUIT XR130R FEMELLE 54-35-54 6191561	U	6978F.2	58,56
101.0022.89	TE REDUIT XR130R FEMELLE 54-42-54 6191570	U	6978H.8	60,25
105.0109.04	TE REDUIT XR130R FEMELLE 76.1-54-76.1 6204385	U	6978J.5	340,74

INOX

RACCORDS INOX A SERTIR



MANCHON XPRESS ACIER INOX

Manchon FF - Type R2701



	DÉSIGNATION	UT	CODE	PPHT (€)
101.0003.63	MANCHON FEMELLE X7270 D.18 6190954	U	69871.5	9,55
101.0004.24	MANCHON FEMELLE X7270 D.22 6190965	U	69871.4	11,15
101.0004.78	MANCHON FEMELLE X7270 D.28 6190976	U	6987K.2	12,58
101.0005.93	MANCHON FEMELLE X7270 D.35 6190987	U	6987L.0	15,60
101.0008.11	MANCHON FEMELLE X7270 D.42 6190998	U	69882.9	21,33
101.0009.71	MANCHON FEMELLE X7270 D.54 6191009	U	69883.7	25,56
105.0039.12	MANCHON FEMELLE X7270 D.76.1 6204154	U	69884.5	122,26
105.0044.73	MANCHON FEMELLE X7270 D.88.9 6204165	U	69886.0	139,79



REDUCTION XPRESS ACIER INOX

Réduction MF - Type R2707



	DÉSIGNATION	UT	CODE	PPHT (€)
101.0004.18	REDUCTION MALE-FEM.X7243 22-18 6191141	U	69909.0	11,01
101.0004.69	REDUCTION MALE-FEM.X7243 28-22 6191174	U	6990D.1	12,35
101.0009.40	REDUCTION MALE-FEM.X7243 35-22 6191196	U	6990F.6	24,74
101.0009.65	REDUCTION MALE-FEM.X7243 35-28 6191207	U	6990G.4	25,40
101.0014.08	REDUCTION MALE-FEM.X7243 42-22 6191218	U	6990H.2	37,04
101.0014.24	REDUCTION MALE-FEM.X7243 42-28 6191229	U	6990I.0	37,47
101.0014.62	REDUCTION MALE-FEM.X7243 42-35 6191231	U	6990J.9	38,47
101.0017.24	REDUCTION MALE-FEM.X7243 54-22 6191240	U	6990K.7	45,36
101.0017.76	REDUCTION MALE-FEM.X7243 54-28 6191251	U	6990L.5	46,74
101.0018.02	REDUCTION MALE-FEM.X7243 54-35 6191262	U	69910.8	47,42
101.0018.41	REDUCTION MALE-FEM.X7243 54-42 6191273	U	69915.7	48,44
105.0029.81	REDUCTION MALE-FEM.X7243 76.1-42 6204211	U	69917.3	93,15
105.0036.21	REDUCTION MALE-FEM.X7243 76.1-54 6204220	U	69918.1	113,15
105.0038.05	REDUCTION MALE-FEM.X7243 88.9-76.1 6204242	U	6991C.2	118,90

RACCORDS INOX A SERTIR ET A VISSER



TE XPRESS ACIER INOX

Té Mixte Taraudé FFF - Type R2718 - Joint EPDM



	DÉSIGNATION	UT	CODE	PPHT (€)
101.0010.58	TE MIXTE TAR.X7130G FF 22X3/4X22 6191636	U	69519.7	27,85
101.0010.43	TE MIXTE 28X1/2X28 6191647	U	9060G.3	27,44
101.0012.33	TE MIXTE TAR.X7130G FF 28X3/4X28 6191658	U	6951C.0	32,46
101.0012.53	TE FEMELLE 35X1/2X35 6191669	U	9613N.2	32,98
101.0015.35	TE MIXTE 42X1/2X42 6191680	U	9749U.6	40,39
101.0017.12	TE MIXTE TAR.X7130G FF 42X3/4X42 6191691	U	6951E.5	45,06
101.0018.20	TE FEM 54X1/2X54 6191702	U	9779S.4	47,89

INOX

RACCORDS INOX A SERTIR ET A VISSER



TE XPRESS ACIER INOX

Té Mixte Taraudé FFF - Type R2718 -

Joint EPDM

- suite



	DÉSIGNATION	UT	CODE	PPHT (€)
101.0019.97	TE MIXTE TAR.X7130G FF 54X3/4X54 6191724	U	6951H.9	52,56
105.0089.21	TE MIXTE TAR.X7130G FF 76.1X3/4X76.1 6204528	U	6951L.2	278,79
105.0113.85	TE MIXTE TAR.X7130G FF 88.9X3/4X88.9 6204539	U	69520.5	355,77



RACCORD XPRESS ACIER INOX

Raccord droit MF - Type R2705



	DÉSIGNATION	UT	CODE	PPHT (€)
101.0007.05	RACCORD MIXTE AV.FIL.MALE 18X1/2 6190602	U	6952E.4	18,54
101.0007.00	RACCORD MIXTE AV.FIL.MALE 18X3/4 6190613	U	6952G.0	18,41
101.0007.57	RACCORD MIXTE AV.FIL.M 22-1/2 6190635	U	4901S.6	19,93
101.0007.96	RACCORD MIXTE AV.FIL.MALE 22X3/4 6190646	U	6991F.5	20,95
101.0010.10	RACCORD MIXTE AV.FIL.MALE 28X1 6190657	U	6952J.5	26,57
101.0014.83	RACCORD MIXTE AV.FIL.MALE 35X11/4 6190701	U	4557E.8	39,02
101.0021.55	RAC MIXTE INOX 42X11/2M 6190712	U	2679W.1	56,70
101.0028.95	RACCORD MIXTE AV.FIL.MALE 54X2 6190745	U	69532.0	76,19
105.0119.11	RACCORD FIL 76.1X21/2 6204759	U	9780P.7	372,22



RACCORD UNION XPRESS ACIER INOX

Raccord union Filetage M - MF - Type R2735



	DÉSIGNATION	UT	CODE	PPHT (€)
101.0016.58	RACCORD UNION FIL.X7341GEI 22X3/4 6192175	U	69542.9	43,63
101.0028.08	RACCORD UNION FIL.X7341GEI 28X1 6192197	U	69547.8	73,90
101.0035.83	RACCORD UNION FIL.X7341GEI 35X11/4 6192208	U	6954C.7	94,29
101.0041.43	RACCORD UNION FIL.X7341GEI 42X11/2 6192219	U	6954D.5	109,03
101.0071.63	RACCORD UNION FIL.X7341GEI 54X2 6192296	U	6954E.2	188,51



RACCORD UNION XPRESS ACIER INOX

Raccord union Filetage F - FF - Type R2738



	DÉSIGNATION	UT	CODE	PPHT (€)
101.0015.83	RACCORD UNION TAR.X7341GEL 22X3/4 6192065	U	6953F.1	41,66
101.0020.43	RACCORD UNION TAR.FF 28X1 6192087	U	90618.0	53,76
101.0025.57	RACCORD UNION TAR.X7341GEL 35X11/4 6192098	U	6953H.7	67,28

INOX

RACCORDS INOX A SERTIR ET A VISSER



RACCORD UNION XPRESS ACIER INOX

Raccord union Filetage F - FF - Type

R2738

- suite



	DÉSIGNATION	UT	CODE	PPHT (€)	ECOPART (€)
101.0031.75	RACCORD UNION TAR.X7341GEL 42X11/2 6192109	U	6953I.5	83,54	
101.0058.35	RACCORD UNION TAR.X7341GEL 54X2 6192111	U	6953J.4	153,56	

SIPHONS DE SOL/CANIVEAU INOX



SIPHON SANS REPRISE D'ETANCHEITE

Siphon inox 100x100 à sortie 40 latérale



	DÉSIGNATION	UT	CODE	PPHT (€)	ECOPART (€)
020.0068.80	SIPHON INOX D.40 100X100 LIMATEC 1040L	U	8688B.8	86,02	0,02



SIPHON SANS REPRISE D'ETANCHEITE

Siphon inox 100x100 à sortie 40 - Rosette à trous, sortie verticale - Deux hauteurs de cuve



	DÉSIGNATION	UT	CODE	PPHT (€)	ECOPART (€)
020.0040.96	SIPHON INOX LIMATEC 1040	U	04790.2	51,22	0,02



SIPHON SANS REPRISE D'ETANCHEITE

Siphon inox 150x150 à sortie 50 verticale ou latérale



	DÉSIGNATION	UT	CODE	PPHT (€)	ECOPART (€)
020.0099.52	SIPHON INOX VERTICAL LIMATEC 1550	U	04792.8	124,42	0,02
020.0108.32	SIPHON INOX VIS INVOLABLE LIMATEC 1550V	U	17182.7	135,42	0,02
020.0133.20	SIPHON INOX HORIZONTAL LIMATEC 1550L	U	04340.8	166,52	0,02



SIPHON SANS REPRISE D'ETANCHEITE

Siphon inox 200x200 à sortie 63 verticale



	DÉSIGNATION	UT	CODE	PPHT (€)	ECOPART (€)
020.0127.36	SIPHON INOX STANDARD LIMATEC 2063F	U	48572.2	159,22	0,02

Le PPHT comprend l'ecopart (€)

INOX

SIPHONS DE SOL/CANIVEAU INOX



SIPHON SANS REPRISE D'ETANCHEITE

Siphons cloche inox 250x250 à sortie verticale 100



	DÉSIGNATION	UT	CODE	PPHT (€)	ECOPART (€)
020.0194.72	SIPHON INOX STANDARD LIMATEC 25100	U	04793.6	243,42	0,02



SIPHINOX® AVEC REPRISE D'ETANCHEITE

Siphons inox pour étanchéité sous carrelage en locaux humides - Gamme 2063



	DÉSIGNATION	UT	CODE	PPHT (€)	ECOPART (€)
020.0345.90	SIPHON 200X200 TELESC. 2063RBDDECO	U	1246C.6	345,92	0,02



SIPHINOX® AVEC REPRISE D'ETANCHEITE

Siphons inox pour étanchéité sous carrelage en locaux humides - Gamme 1550

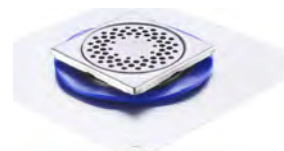

	DÉSIGNATION	UT	CODE	PPHT (€)	ECOPART (€)
020.0146.40	SIPHON INOX SV LIMATEC 1550RBD	U	1529E.9	183,02	0,02

Pour plus d'infos,
consultez
le CAHIER TECHNIQUE
page 14

ISOLATION

GAINÉ ISOLANTE

GAINÉ ISOLANTE
 Double paroi 750N

	DÉSIGNATION	UT	CODE	PPHT (€)
241.0097.37	GAINÉ DOUBLE PAROI 750N 50MM 50M	U	214WX.3	162,29

MANCHON K-FLEX® ST

 Manchon isolant non fendu : LG 2 ml -
 Epaisseur 13 mm

	DÉSIGNATION	UT	CODE	PPHT (€)	ECOPART (€)
690.0002.33	GAINÉ ISOL.K-FLEX ST EP.13 D6 ST13X006	M	283X7.9	2,34	0,01
690.0002.42	GAINÉ ISOL.K-FLEX ST EP.13 D10 ST13X010	M	283X9.5	2,43	0,01
690.0002.47	GAINÉ ISOL.K-FLEX ST EP.13 D12 ST13X012	M	283XA.2	2,48	0,01
690.0001.98	GAINÉ ISOL.K-FLEX ST EP.13 ST13X015	M	283XB.0	2,65	0,01
690.0002.05	GAINÉ ISOL.K-FLEX ST EP.13 ST13X018	M	283XC.8	2,74	0,01
690.0002.30	GAINÉ ISOL.K-FLEX ST EP.13 ST13X020	M	288KQ.8	3,08	0,01
690.0002.38	GAINÉ ISOL.K-FLEX ST EP.13 ST13X022	M	283XD.6	3,19	0,01
690.0002.51	GAINÉ ISOL.K-FLEX ST EP.13 ST13X025	M	283XE.3	3,36	0,01
690.0002.63	GAINÉ ISOL.K-FLEX ST EP.13 ST13X028	M	283XF.1	3,52	0,01
690.0002.97	GAINÉ ISOL.K-FLEX ST EP.13 ST13X032	M	288KR.6	3,97	0,01
690.0003.08	GAINÉ ISOL.K-FLEX ST EP.13 ST13X035	M	283XG.9	4,12	0,01
690.0003.45	GAINÉ ISOL.K-FLEX ST EP.13 ST13X040	M	288KS.4	4,61	0,01
690.0003.46	GAINÉ ISOL.K-FLEX ST EP.13 ST13X042	M	283XH.7	4,63	0,01
690.0004.11	GAINÉ ISOL.K-FLEX ST EP.13 ST13X048	M	288KT.2	5,49	0,01
690.0004.60	GAINÉ ISOL.K-FLEX ST EP.13 ST13X050	M	288KU.9	6,14	0,01
690.0004.72	GAINÉ ISOL.K-FLEX ST EP.13 ST13X054	M	288KV.7	6,30	0,01
690.0005.21	GAINÉ ISOL.K-FLEX ST EP.13 ST13X060	M	288KW.5	6,96	0,01
690.0006.90	GAINÉ ISOL.K-FLEX ST EP.13 ST13X064	M	288KX.3	9,21	0,01
690.0007.48	GAINÉ ISOL.K-FLEX ST EP.13 ST13X076	M	288KY.1	9,99	0,01
690.0009.98	GAINÉ ISOL.K-FLEX ST EP.13 ST13X089	M	288KZ.0	13,32	0,01
690.0014.06	GAINÉ ISOL.K-FLEX ST EP.13 ST13X114	M	288L0.9	18,75	0,01

MANCHON K-FLEX® ST

 Manchon isolant non fendu : LG 2 ml -
 Epaisseur 19 mm

	DÉSIGNATION	UT	CODE	PPHT (€)	ECOPART (€)
690.0003.52	GAINÉ ISOL.K-FLEX ST EP.19 ST19X015	M	288L2.5	4,70	0,01
690.0003.67	GAINÉ ISOL.K-FLEX ST EP.19 ST19X018	M	288L3.3	4,90	0,01
690.0003.99	GAINÉ ISOL.K-FLEX ST EP.19 ST19X020	M	288L4.1	5,33	0,01
690.0004.11	GAINÉ ISOL.K-FLEX ST EP.19 ST19X022	M	283XJ.4	5,49	0,01
690.0004.60	GAINÉ ISOL.K-FLEX ST EP.19 ST19X025	M	283XK.2	6,15	0,01
690.0005.03	GAINÉ ISOL.K-FLEX ST EP.19 ST19X028	M	283XL.0	6,72	0,01
690.0005.40	GAINÉ ISOL.K-FLEX ST EP.19 ST19X032	M	288L5.8	7,21	0,01
690.0005.76	GAINÉ ISOL.K-FLEX ST EP.19 ST19X035	M	283XM.8	7,69	0,01
690.0007.64	GAINÉ ISOL.K-FLEX ST EP.19 ST19X040	M	288L6.6	10,20	0,01
690.0010.21	GAINÉ ISOL.K-FLEX ST EP.19 ST19X042	M	283XN.6	10,22	0,01
690.0011.55	GAINÉ ISOL.K-FLEX ST EP.19 ST19X048	M	288L7.4	11,56	0,01

ISOLATION

GAINÉ ISOLANTE

MANCHON K-FLEX® ST

 Manchon isolant non fendu : LG 2 ml -
 Epaisseur 19 mm
 - suite

	DÉSIGNATION	UT	CODE	PPHT (€)	ECOPART (€)
690.0011.75	GAINÉ ISOL.K-FLEX ST EP.19 ST19X050	M	288L8.2	11,76	0,01
690.0012.17	GAINÉ ISOL.K-FLEX ST EP.19 ST19X054	M	288L9.0	12,18	0,01
690.0013.24	GAINÉ ISOL.K-FLEX ST EP.19 ST19X060	M	288LA.7	13,25	0,01
690.0015.72	GAINÉ ISOL.K-FLEX ST EP.19 ST19X064	M	288LB.5	15,73	0,01
690.0019.51	GAINÉ ISOL.K-FLEX ST EP.19 ST19X076	M	288LC.3	19,52	0,01
690.0021.72	GAINÉ ISOL.K-FLEX ST EP.19 ST19X089	M	288LD.1	21,73	0,01
690.0032.02	GAINÉ ISOL.K-FLEX ST EP.19 ST19X114	M	288LF.6	32,03	0,01

MANCHON K-FLEX® ST

 Manchon isolant non fendu : LG 2 ml -
 Epaisseur 25 mm

	DÉSIGNATION	UT	CODE	PPHT (€)	ECOPART (€)
690.0009.70	GAINÉ ISOL.K-FLEX ST EP.25 ST25X018	M	288LM.3	9,71	0,01
690.0007.66	GAINÉ ISOL.K-FLEX ST EP.25 ST25X022	M	288LN.1	10,23	0,01
690.0009.20	GAINÉ ISOL.K-FLEX ST EP.25 ST25X028	M	288LP.9	12,28	0,01
690.0009.47	GAINÉ ISOL.K-FLEX ST EP.25 ST25X032	M	288LQ.7	12,64	0,01
690.0009.60	GAINÉ ISOL.K-FLEX ST EP.25 ST25X035	M	283XP.4	12,81	0,01
690.0012.89	GAINÉ ISOL.K-FLEX ST EP.25 ST25X040	M	288LR.5	17,20	0,01
690.0013.15	GAINÉ ISOL.K-FLEX ST EP.25 ST25X042	M	283XQ.2	17,54	0,01
690.0016.20	GAINÉ ISOL.K-FLEX ST EP.25 ST25X050	M	288LT.1	21,61	0,01
690.0016.27	GAINÉ ISOL.K-FLEX ST EP.25 ST25X054	M	288LU.8	21,70	0,01
690.0020.17	GAINÉ ISOL.K-FLEX ST EP.25 ST25X064	M	288LW.4	26,90	0,01
690.0021.48	GAINÉ ISOL.K-FLEX ST EP.25 ST25X076	M	288LY.0	28,65	0,01
690.0025.71	GAINÉ ISOL.K-FLEX ST EP.25 ST25X089	M	288LZ.9	34,29	0,01

MANCHON K-FLEX® ST

 Manchon isolant non fendu : LG 2 ml -
 Epaisseur 32 mm

	DÉSIGNATION	UT	CODE	PPHT (€)	ECOPART (€)
690.0009.64	GAINÉ ISOL.K-FLEX ST EP.32 ST32X022	M	288MA.6	12,87	0,01
690.0011.12	GAINÉ ISOL.K-FLEX ST EP.32 ST32X028	M	288MB.4	14,84	0,01
690.0013.05	GAINÉ ISOL.K-FLEX ST EP.32 ST32X035	M	288MC.2	17,41	0,01
690.0016.22	GAINÉ ISOL.K-FLEX ST EP.32 ST32X042	M	288ME.7	21,63	0,01
690.0019.15	GAINÉ ISOL.K-FLEX ST EP.32 ST32X054	M	288MG.3	25,54	0,01
690.0023.25	GAINÉ ISOL.K-FLEX ST EP.32 ST32X064	M	288MJ.8	31,01	0,01

ISOLATION

GAINE ISOLANTE



MANCHON K-FLEX® ST

Manchon isolant non fendu : LG 2 ml -
Épaisseur 40 mm



	DÉSIGNATION	UT	CODE	PPHT (€)	ECOPART (€)
690.0032.96	GAINE ISOL. K-FLEX ST EP.40 ST40X042	M	288MU.7	43,95	0,01
690.0036.54	GAINE ISOL. K-FLEX ST EP.40 ST40X054	M	288MX.1	48,73	0,01
690.0038.76	GAINE ISOL. K-FLEX ST EP.40 ST40X064	M	288MZ.8	51,69	0,01
690.0040.29	GAINE ISOL. K-FLEX ST EP.40 ST40X076	M	288N1.5	53,73	0,01



MANCHON K-FLEX® ST FAST

Adhésif à recouvrement - Épaisseur 13 mm



	DÉSIGNATION	UT	CODE	PPHT (€)	ECOPART (€)
690.0002.81	GAINE ADH. K-FLEX ST FAST EP.13MM ST13X015R	M	288NZ.7	3,76	0,01
690.0003.01	GAINE ADH. K-FLEX ST FAST EP.13MM ST13X018R	M	288PO.1	4,02	0,01
690.0003.35	GAINE ADH. K-FLEX ST FAST EP.13MM ST13X022R	M	288P2.7	4,48	0,01
690.0003.83	GAINE ADH. K-FLEX ST FAST EP.13MM ST13X028R	M	288P4.3	5,12	0,01
690.0004.35	GAINE ADH. K-FLEX ST FAST EP.13MM ST13X035R	M	288P7.6	5,81	0,01
690.0004.82	GAINE ADH. K-FLEX ST FAST EP.13MM ST13X042R	M	288P8.4	6,43	0,01



MANCHON K-FLEX® ST FAST

Adhésif à recouvrement - Épaisseur 19 mm



	DÉSIGNATION	UT	CODE	PPHT (€)	ECOPART (€)
690.0004.84	GAINE ADH. K-FLEX ST FAST EP.19MM ST19X015R	M	288PP.1	6,44	0,01
690.0005.42	GAINE ADH. K-FLEX ST FAST EP.19MM ST19X020R	M	288PR.7	7,23	0,01
690.0006.35	GAINE ADH. K-FLEX ST FAST EP.19MM ST19X025R	M	288PV.8	8,48	0,01
690.0006.63	GAINE ADH. K-FLEX ST FAST EP.19MM ST19X028R	M	288PW.6	8,85	0,01
690.0006.99	GAINE ADH. K-FLEX ST FAST EP.19MM ST19X032R	M	288PX.4	9,33	0,01
690.0009.56	GAINE ADH. K-FLEX ST FAST EP.19MM ST19X042R	M	288Q0.0	12,75	0,01
690.0010.67	GAINE ADH. K-FLEX ST FAST EP.19MM ST19X050R	M	288Q2.6	14,24	0,01
690.0011.36	GAINE ADH. K-FLEX ST FAST EP.19MM ST19X054R	M	288Q3.4	15,16	0,01
690.0014.00	GAINE ADH. K-FLEX ST FAST EP.19MM ST19X064R	M	288Q5.9	18,68	0,01



MANCHON K-FLEX® ST FAST

Adhésif à recouvrement - Épaisseur 25 mm



	DÉSIGNATION	UT	CODE	PPHT (€)	ECOPART (€)
690.0011.19	GAINE ADH. K-FLEX ST FAST EP.25MM ST25X028R	M	288R6.6	14,93	0,01
690.0011.36	GAINE ADH. K-FLEX ST FAST EP.25MM ST25X032R	M	288R7.4	15,16	0,01
690.0014.41	GAINE ADH. K-FLEX ST FAST EP.25MM ST25X040R	M	288RA.7	19,22	0,01
690.0015.44	GAINE ADH. K-FLEX ST FAST EP.25MM ST25X042R	M	288RB.5	20,59	0,01
690.0018.96	GAINE ADH. K-FLEX ST FAST EP.25MM ST25X050R	M	288RE.8	25,29	0,01

Le PPHT comprend l'ecopart (€)

ISOLATION

GAINE ISOLANTE



MANCHON K-FLEX® ST FAST

Adhésif à recouvrement - Épaisseur 32 mm



	DÉSIGNATION	UT	CODE	PPHT (€)	ECOPART (€)
690.0016.36	GAINE ADH. K-FLEX ST FAST EP.32MM ST32X035R	M	288RT.1	21,82	0,01
690.0019.95	GAINE ADH. K-FLEX ST FAST EP.32MM ST32X042R	M	288RU.8	26,61	0,01
690.0024.30	GAINE ADH. K-FLEX ST FAST EP.32MM ST32X054R	M	288RZ.9	32,41	0,01
690.0029.92	GAINE ADH. K-FLEX ST FAST EP.32MM ST32X064R	M	288S1.6	39,90	0,01



ACCESSOIRES

Colle K-Flex - Avec pinceau



	DÉSIGNATION	UT	CODE	PPHT (€)
900.0011.71	COLLE K-FLEX + PINCEAU POT 0.25L AC0L02	U	3523A.0	14,64



ACCESSOIRES

Bande de désolidarisation, adhésive, B-s, d0
- Rubaflex - Noir - épaisseur 4 mm



	DÉSIGNATION	UT	CODE	PPHT (€)	ECOPART (€)
690.0051.66	BANDE ISOL.ADH.L25MX250MMX4MM TA25250	U	14553.2	129,17	0,01

PROTECTION



GAINE PVC

Annelée Souple - Couronne



	DÉSIGNATION	UT	CODE	PPHT (€)
241.0059.10	GAINE PVC SOUPLE ANNELEE N 16 -COUR.- 100M	U	44389.5	98,50
241.0034.63	GAINE PVC SOUPLE ANNELEE N 19 -COUR.- 50M	U	44397.8	57,71
241.0055.87	GAINE PVC SOUPLE ANNELEE N 23 -COUR.- 50M	U	44398.6	93,11
241.0078.03	GAINE PVC SOUPLE ANNELEE N 29 -COUR.- 50M	U	44453.9	130,05



FOURREAU DE PROTECTION TPC

Annelé/lisse - Bleu



	DÉSIGNATION	UT	CODE	PPHT (€)
241.0127.17	FOURREAU TPC ANNELE/LISSE BLEU -COUR.50M- 50	U	72738.8	254,34
241.0155.52	FOURREAU TPC ANNELE/LISSE BLEU -COUR.50M- 63	U	72762.8	311,04

ISOLATION

PROTECTION

**FOURREAU DE PROTECTION TPC**Annelé/lisse - Bleu
- suite

	DÉSIGNATION	UT	CODE	PPHT (€)
241.0265.68	FOURREAU TPC ANNELE/LISSE BLEU - COUR.50M- 90	U	72814.7	531,36

**FOURREAU DE PROTECTION TPC**

Annelé/lisse - Jaune



	DÉSIGNATION	UT	CODE	PPHT (€)
241.0127.57	FOURREAU TPC ANNELE/LISSE JAUNE - COUR.50M- 40	U	72818.8	182,25
241.0127.17	FOURREAU TPC ANNELE/LISSE JAUNE - COUR.50M- 50	U	72822.0	254,34
241.0155.52	FOURREAU TPC ANNELE/LISSE JAUNE - COUR.50M- 63	U	72836.0	311,04

**GRILLAGE AVERTISSEUR**

Normalisé - Bleu

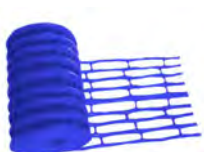

	DÉSIGNATION	UT	CODE	PPHT (€)
920.0032.80	GRILLAGE AVERTISSEUR NORMALISE BLEU 100X30	U	57768.4	43,74

**TOILE DE COTON PLATREE**

Protection des isolants et des calorifugeages



	DÉSIGNATION	UT	CODE	PPHT (€)
921.0011.18	TOILE DE COTON PLATREE 0,12X5M 816299	U	3158C.8	13,98

Pour plus d'infos,
consultez
le CAHIER TECHNIQUE
page 14

J+0 100% DISPO



L'atout LIBRE-SERVICE

- Un large choix de produits
- Tous les produits de ce catalogue à votre disposition
- Une équipe à votre service

Serena®

by sferaco

QUAND L'ÉCORESPONSABLE RENCONTRE LA HAUTE PERFORMANCE



PN40



Poignée réversible



Étanchéité à l'axe par presse-étoupe



Laiton Sans Plomb CW724R-4MS non-dézinçifiable à Haute Performance Mécanique.



Sphère chromée percée : moins de bactéries et moins d'entartrage



Traçabilité renforcée : suivi garanti



ROBINETTERIE, COMPTEURS & RACCORDS



Robinetterie bâtiment

SOMMAIRE

ROBINETTERIE BATIMENT

VANNE A SPHERE LAITON	122
VANNE A SPHERE ACIER-INOX	125
VANNE A SPHERE PLASTIQUE	125
VANNE PAPILLON FONTE	126
AUTRE ROBINETTERIE	126
COMPTAGE ET DETENTE	126
FILTRE	130
CLAPET ET CREPINE	130
DISCONNECTEUR	131
ROBINETTERIE A CLAPET	132
ACCESSOIRES ET EQUIPEMENT SANITAIRE	133
FLEXIBLE DE RACCORDEMENT	135
RACCORD D'ARROSAGE	136
BOUCHE D'ARROSAGE	136
JOINT D'ETANCHEITE	137

ROBINETTERIE BATIMENT

VANNE A SPHERE LAITON



VANNE A SPHERE FF - Manette papillon



	DÉSIGNATION	UT	CODE	PPHT (€)
430.0009.61	VANNE AV.COMPTEUR PAP. FF3/4-3/4	U	13341.3	19,23



VANNE A SPHERE FF - Manette papillon rouge



	DÉSIGNATION	UT	CODE	PPHT (€)
430.0010.89	ROBINET SPH.P.INT.PAPILLON FF GRE-CHR 12X17	U	11829.9	14,52
430.0011.05	ROBINET SPH.P.INT.PAPILLON FF GRE-CHR 15X21	U	11831.5	14,73
430.0015.41	ROBINET SPH.P.INT.PAPILLON FF GRE-CHR 20X27	U	11832.3	20,55
430.0026.24	ROBINET SPH.P.INT.PAPILLON FF GRE-CHR 26X34	U	18297.2	34,98



VANNE A SPHERE FF - Poignée acier plate verte - NF



	DÉSIGNATION	UT	CODE	PPHT (€)
430.0008.96	VANNE SPHERE FF POIGNEE VERTE NF 1/2	U	1511P.0	11,94
430.0013.22	VANNE SPHERE FF POIGNEE VERTE NF 3/4	U	1511T.2	17,63
430.0035.32	VANNE SPHERE FF POIGNEE VERTE NF 1"1/4	U	1511W.5	47,10
430.0050.20	VANNE SPHERE FF POIGNEE VERTE NF 1"1/2	U	1511X.3	66,94
430.0021.02	VANNE SPHERE FF POIGNEE VERTE NF 1"	U	1511V.7	28,03
430.0077.28	VANNE SPHERE FF POIGNEE VERTE NF 2"	U	1511Y.1	103,04



VANNE A SPHERE MF - Manette papillon rouge



	DÉSIGNATION	UT	CODE	PPHT (€)
430.0012.51	ROBINET SPH.P.INT.PAPILLON MF GRE-CHR 12X17	U	18357.4	16,68
430.0012.51	ROBINET SPH.P.INT.PAPILLON MF GRE-CHR 15X21	U	18358.2	16,68
430.0016.78	ROBINET SPHERE P.INT.PAP.MF GRE-CHR 20X27	U	40533.2	22,38
430.0029.32	ROBINET SPH.P.INT.PAPILLON MF GRE-CHR 26X34	U	18359.0	39,09

ROBINETTERIE BATIMENT

VANNE A SPHERE LAITON



VANNE A SPHERE MF - Manette papillon verte - NF



	DÉSIGNATION	UT	CODE	PPHT (€)
430.0010.30	VANNE SPHERE MF MANETTE VERTE NF 3/8	U	1513T.0	13,73
430.0009.96	VANNE SPHERE MF MANETTE VERTE NF 1/2	U	1513U.7	13,28
430.0015.50	VANNE SPHERE MF MANETTE VERTE NF 3/4	U	1513V.5	20,67



VANNE A SPHERE MF - Poignée acier plate verte - NF



	DÉSIGNATION	UT	CODE	PPHT (€)
430.0010.30	VANNE SPHERE MF POIGNEE VERTE NF 3/8	U	1512X.2	13,73
430.0009.98	VANNE SPHERE MF POIGNEE VERTE NF 1/2	U	1512Y.0	13,31
430.0015.50	VANNE SPHERE MF POIGNEE VERTE NF 3/4	U	15130.8	20,67
430.0024.76	VANNE SPHERE MF POIGNEE VERTE NF 1"	U	1513M.2	33,02
430.0058.96	VANNE SPHERE MF POIGNEE VERTE NF 1"1/2	U	1513P.8	78,62
430.0041.84	VANNE SPHERE MF POIGNEE VERTE NF 1"1/4	U	1513N.0	55,78
430.0103.30	VANNE SPHERE MF POIGNEE VERTE NF 2"	U	1513R.4	137,73



VANNE A SPHERE MF - A écrou tournant - Pour compteur



	DÉSIGNATION	UT	CODE	PPHT (€)
430.0010.95	VANNE AVANT COMPTEUR PAP. MF 1/2-3/4	U	84519.8	24,34
430.0007.60	VANNE AVANT COMPTEUR PAP. MF 3/4-3/4	U	8451D.9	16,88



VANNE A SPHERE MF - Equerre - A écrou tournant pour compteur



	DÉSIGNATION	UT	CODE	PPHT (€)
430.0009.10	VANNE EQUERRE AVANT COMPTEUR MF 1/2-3/4	U	8451E.6	20,23
430.0012.88	VANNE EQUERRE AVANT COMPTEUR MF 3/4-3/4	U	8451F.4	28,63

ROBINETTERIE BATIMENT

VANNE A SPHERE LAITON



VANNE A SPHERE

MM - Manette papillon rouge



	DÉSIGNATION	UT	CODE	PPHT (€)
430.0012.69	ROBINET SPHERE P.INT.PAP.MM GRE-CHR 12X17	U	47699.4	16,92
430.0012.92	ROBINET SPHERE P.INT.PAP.MM GRE-CHR 15X21	U	67083.6	17,22
430.0017.89	ROBINET SPHERE P.INT.PAP.MM GRE-CHR 20X27	U	67085.1	23,85
430.0029.34	ROBINET SPHERE P.INT.PAP.MM GRE-CHR 26X34	U	18301.2	39,12



VANNE A SPHERE

MM - Poignée acier plate verte - NF



	DÉSIGNATION	UT	CODE	PPHT (€)
430.0008.84	VANNE SPHERE MM POIGNEE VERTE NF 3/8	U	1514N.9	11,78
430.0010.70	VANNE SPHERE MM POIGNEE VERTE NF 1/2	U	1514P.7	14,27
430.0015.72	VANNE SPHERE MM POIGNEE VERTE NF 3/4	U	1514Q.5	20,96
430.0024.38	VANNE SPHERE MM POIGNEE VERTE NF 1"	U	1514R.3	32,51



VANNE A SPHERE

Mini vanne, écrou prisonnier - MF



	DÉSIGNATION	UT	CODE	PPHT (€)
430.0007.00	VANNE 2 PIECES DEPART NOURRICE MF 15X21	U	9538J.2	8,75



ROBINET A BOISSEAU

FF - Chauffage



	DÉSIGNATION	UT	CODE	PPHT (€)
430.0017.92	ROBINET BOISSEAU LAIT.10B FIL1/4 TAR1/4 611L2	U	66001.9	23,89



ROBINET A BOISSEAU

MF - Chauffage



	DÉSIGNATION	UT	CODE	PPHT (€)
430.0018.59	ROBINET BOISSEAU LAIT.10B FIL1/2 TAR1/2 611L3	U	66003.5	24,79

ROBINETTERIE BATIMENT

VANNE A SPHERE LAITON



ROBINET A BOISSEAU

MF - Porte manomètre - Avec décompression



	DÉSIGNATION	UT	CODE	PPHT (€)
430.0013.31	ROBINET BOISSEAU SPH.LAIT.PN40 1/2" 609L3	U	57504.3	21,46



VANNE A SPHERE

Série ASTER ACS - FF - PN40 - Levier aluminium



	DÉSIGNATION	UT	CODE	PPHT (€)
430.0011.00	VANNE BS ASTER PN40 FF 1/2" 0804R404	U	2405Z.7	14,67
430.0015.45	VANNE BS ASTER PN40 FF 3/4" 0804R405	U	240A0.1	20,60
430.0022.46	VANNE BS ASTER PN40 FF 1" 0804R406	U	240A2.7	29,94
430.0039.39	VANNE BS ASTER PN40 FF 1"1/4 0804R407	U	240A3.5	52,52
430.0057.14	VANNE BS ASTER PN40 FF 1"1/2 0804R408	U	240A6.8	76,19
430.0089.41	VANNE BS ASTER PN40 FF 2" 0804R409	U	240A7.6	119,21



VANNE A SPHERE

Série ASTER ACS - MF - PN40 - Levier aluminium



	DÉSIGNATION	UT	CODE	PPHT (€)
430.0012.54	VANNE BS ASTER PN40 MF 1/2" 0805R404	U	240A9.2	16,72
430.0017.21	VANNE BS ASTER PN40 MF 3/4" 0805R405	U	240AA.9	22,95
430.0024.11	VANNE BS ASTER PN40 MF 1" 0805R406	U	240AC.5	32,15
430.0041.81	VANNE BS ASTER PN40 MF 1"1/4 0805R407	U	240AD.3	55,75
430.0060.45	VANNE BS ASTER PN40 MF 1"1/2 0805R408	U	240AE.0	80,60
430.0093.16	VANNE BS ASTER PN40 MF 2" 0805R409	U	240AF.8	124,22



VANNE A SPHERE

Série ASTER ACS - MM - PN40 - Levier aluminium



	DÉSIGNATION	UT	CODE	PPHT (€)
430.0013.14	VANNE BS ASTER PN40 MM 1/2" 0806R404	U	240AH.4	17,52
430.0018.10	VANNE BS ASTER PN40 MM 3/4" 0806R405	U	240AJ.1	24,13
430.0025.40	VANNE BS ASTER PN40 MM 1" 0806R406	U	240AK.9	33,86
430.0043.95	VANNE BS ASTER PN40 MM 1"1/4 0806R407	U	240AL.7	58,60
430.0063.41	VANNE BS ASTER PN40 MM 1"1/2 0806R408	U	240AM.5	84,55
430.0097.84	VANNE BS ASTER PN40 MM 2" 0806R409	U	240AP.1	130,45

ROBINETTERIE BATIMENT

VANNE A SPHERE LAITON



ROBINETTERIE, COMPTEURS & RACCORDES

VANNE A SPHERE

FF - A écrou tournant pour compteur - 641
- NF - Manette 2/3 laiton verte



	DÉSIGNATION	UT	CODE	PPHT (€)	ECOPART (€)
430.0025.49	VANNE SPHERE 641 MP 3/4EP-1/2F NF 641054	U	72681.0	34,00	0,01
430.0025.49	VANNE 641 MP 3/4EP-3/4F FF+NF 641055	U	63266.1	34,00	0,01



ROBINETTERIE, COMPTEURS & RACCORDES

VANNE A SPHERE

FF - Passage intégral - 509 - Poignée acier plate rouge



	DÉSIGNATION	UT	CODE	PPHT (€)	ECOPART (€)
430.0011.25	VANNE SPHERE PASS.INT.P.RGE FF 1/4" 509002	U	30597.9	15,00	
430.0011.25	VANNE SPHERE PASS.INT.P.RGE FF 3/8" 509003	U	30598.7	15,00	
430.0010.53	VANNE SPHERE PASS.INT.P.RGE FF 1/2" 509004	U	30599.5	14,05	0,01
430.0014.69	VANNE SPHERE PASS.INT.P.RGE FF 3/4" 509005	U	30600.1	19,60	0,01
430.0026.24	VANNE SPHERE 509 PASS.INT.P.RGE FF 1" 509006	U	30602.7	34,99	0,01
430.0042.50	VANNE SPHERE PASS.INT.P.RGE FF 1"1/4 509007	U	30603.5	56,69	0,02
430.0062.62	VANNE SPHERE PASS.INT.P.RGE FF 1"1/2 509008	U	30604.3	83,51	0,02
430.0096.75	VANNE SPHERE PASS.INT.P.RGE FF 2" 509009	U	30606.8	129,03	0,03
430.0222.72	VANNE SPHERE PASS.INT.P.RGE FF 2"1/2 509010	U	30607.6	297,03	0,07
430.0293.49	VANNE SPHERE PASS.INT.P.RGE FF 3" 509011	U	30608.4	391,42	0,10



ROBINETTERIE, COMPTEURS & RACCORDES

VANNE A SPHERE

MF - A écrou tournant pour compteur - 636 -
Manette papillon rouge



	DÉSIGNATION	UT	CODE	PPHT (€)	ECOPART (€)
430.0021.74	VANNE SPHERE AV.COMPT.ALU.RGE M3/4"1/2 636054	U	79028.7	28,99	0,01



ROBINETTERIE, COMPTEURS & RACCORDES

VANNE A SPHERE

MF - A écrou tournant pour compteur - 642 -
NF - Manette 2/3 -1/3 laiton Verte



	DÉSIGNATION	UT	CODE	PPHT (€)	ECOPART (€)
430.0025.49	VANNE AV.COMPT.LAIT. 3/4"-1/2" MF+NF 642054	U	57403.8	34,00	0,01
430.0019.73	VANNE AV.COMPT.LAIT.3/4"-3/4" MF+NF 642055	U	57407.9	26,32	0,01



ROBINETTERIE, COMPTEURS & RACCORDES

VANNE A SPHERE

MF - A écrou tournant pour compteur -
642 - NF - Manette 2/3 -1/3 laiton Verte



	DÉSIGNATION	UT	CODE	PPHT (€)	ECOPART (€)
430.0049.06	VANNE SPHERE AV.COMPT.LAIT. 1"-1" 642066	U	21330.6	65,43	0,01

ROBINETTERIE BATIMENT

VANNE A SPHERE LAITON



ROBINETTERIE, COMPTEURS & RACCORDES

VANNE A SPHERE

MF - A écrou tournant pour compteur -
Equerre - 644 - Manette 2/3-1/3 laiton



	DÉSIGNATION	UT	CODE	PPHT (€)	ECOPART (€)
430.0024.41	VANNE AV.COMPT.LAIT.EQ.MF 3/4" NF 644055	U	68405.0	32,56	0,01



ROBINETTERIE, COMPTEURS & RACCORDES

VANNE A SPHERE

MF - Passage intégral - 571 - Poignée acier
plate rouge



	DÉSIGNATION	UT	CODE	PPHT (€)	ECOPART (€)
430.0012.92	VANNE SPHERE PASS.INT.PGN.RGE MF 3/8 571003	U	33823.6	17,23	
430.0012.92	VANNE SPHERE PASS.INT.PGN.RGE MF 1/2" 571004	U	33824.4	17,24	0,01
430.0017.34	VANNE SPHERE PASS.INT.PGN.RGE MF 3/4" 571005	U	33825.1	23,13	0,01
430.0029.31	VANNE SPHERE PASS.INT.PGN.RGE MF 1" 571006	U	33826.9	39,09	0,01
430.0049.14	VANNE SPHERE PASS.INT.PGN.RGE MF 1"1/4 571007	U	33827.7	65,54	0,02
430.0070.49	VANNE SPHERE PASS.INT.PGN.RGE MF 1"1/2 571008	U	33829.3	94,01	0,02
430.0104.02	VANNE SPHERE PASS.INT.PGN.RGE MF 2" 571009	U	33830.1	138,72	0,03



ROBINETTERIE, COMPTEURS & RACCORDES

VANNE A SPHERE

MM - Passage intégral - 566 - Poignée acier
plate rouge



	DÉSIGNATION	UT	CODE	PPHT (€)	ECOPART (€)
430.0013.11	VANNE SPHERE PASS.INT.PGN.RGE MM 3/8 566003	U	33803.8	17,48	
430.0013.34	VANNE SPHERE PASS.INT.PGN.RGE MM 1/2" 566004	U	33807.9	17,80	0,01
430.0018.48	VANNE SPHERE PASS.INT.PGN.RGE MM 3/4" 566005	U	33809.5	24,65	0,01
430.0029.34	VANNE SPHERE PASS.INT.PGN.RGE MM 1" 566006	U	33812.9	39,13	0,01
430.0052.78	VANNE SPHERE PASS.INT.PGN.RGE MM 1"1/4 566007	U	33816.0	70,40	0,02
430.0071.80	VANNE SPHERE PASS.INT.PGN.RGE MM 1"1/2 566008	U	33817.8	95,75	0,02
430.0105.86	VANNE SPHERE PASS.INT.PGN.RGE MM 2" 566009	U	33820.2	141,17	0,03



ROBINETTERIE, COMPTEURS & RACCORDES

VANNE A SPHERE DE PUIPAGE

Mâle cannelé - Sphère laiton chromée -
Presse-étoupe - Raccord au nez (brise
jet) - 682 - Poignée acier plate rouge



	DÉSIGNATION	UT	CODE	PPHT (€)	ECOPART (€)
430.0026.39	VANNE SPHERE ROB.PUIS.TETINE 19 3/4 682055	U	12724.1	35,20	0,01
430.0017.27	VANNE SPHERE ROB.PUIS.TETINE 17 1/2 682045	U	25509.1	23,04	0,01

Le PPHT comprend l'ecopart (€)

ROBINETTERIE BATIMENT

VANNE A SPHERE LAITON



VANNE A SPHERE DE PUISAGE

Mâle cannelé - Sphère laiton chromée - Presse-étoupe - Raccord au nez (brise jet) - 681 - Manette laiton 2/3-1/3



	DÉSIGNATION	UT	CODE	PPHT (€)	ECOPART (€)
430.0019.81	VANNE SPHERE ROB.PU.BROS.TET.17 1/2" 681045	U	62908.9	26,42	0,01



VANNE A SPHERE DE PUISAGE

Mâle cannelé - Sphère laiton chromée - Presse-étoupe - Raccord au nez (brise jet) - 699 - Cadenassable



	DÉSIGNATION	UT	CODE	PPHT (€)	ECOPART (€)
430.0021.26	VANNE SPHERE ROB.PUIS.CADENAS 1/2-3/4 699045	U	71855.1	21,26	



VANNE A SPHERE DE PUISAGE

Mâle cannelé - Sphère laiton - Avec tête cache entrée - Avec raccord au nez (brise-jet incorporé) - 680 - Corps nickelé



	DÉSIGNATION	UT	CODE	PPHT (€)	ECOPART (€)
430.0035.33	VANNE SPHERE ROB.PUIS.CACHE ENT. 1/2 680045	U	47524.4	35,34	0,01



VANNE A SPHERE DE PUISAGE

Accessoires pour robinet de puisage - 98104 - Clé pour cache-entrée



	DÉSIGNATION	UT	CODE	PPHT (€)	ECOPART (€)
430.0011.03	CLE CACHE ENTREE CARRE CHROME 9810401	U	52975.0	11,03	



VANNE A SPHERE GAZ

À visser pour tube acier + cuivre - Poignée acier plate jaune - Passage intégral - 620 - Femelle - Femelle



	DÉSIGNATION	UT	CODE	PPHT (€)	ECOPART (€)
430.0014.27	VANNE SPHERE LAIT.GAZ.PGN.JNE FF 1/2 620004	U	71857.7	19,04	0,01
430.0022.09	VANNE SPHERE LAIT.GAZ.PGN.JNE FF 3/4 620005	U	71859.3	29,46	0,01
430.0032.80	VANNE SPHERE LAIT.GAZ.PGN.JNE FF 1" 620006	U	71860.1	43,75	0,01
430.0057.08	VANNE SPHERE LAIT.GAZ.PGN.JNE FF 1"1/4 620007	U	71862.7	76,13	0,02
430.0079.49	VANNE SPHERE LAIT.GAZ.PGN.JNE FF 1"1/2 620008	U	71866.8	106,02	0,03
430.0116.84	VANNE SPHERE LAIT.GAZ.PGN.JNE FF 2" 620009	U	72082.1	155,83	0,04

Le PPHT comprend l'ecopart (€)

ROBINETTERIE BATIMENT

VANNE A SPHERE ACIER-INOX



VANNE A SPHERE 2 PIECES

FF - Passage intégral - 714 - Poignée inox plate rouge cadenassable



	DÉSIGNATION	UT	CODE	PPHT (€)	ECOPART (€)
430.0069.79	VANNE SPHERE T.2PCS HT ORANGE FF 1/2" 714004	U	2875M.2	107,38	0,01
430.0093.48	VANNE SPHERE T.2PCS HT ORANGE FF 3/4" 714005	U	1319X.7	143,83	0,01

VANNE A SPHERE PLASTIQUE



VANNE A BILLE

FF - PVC pression - A coller - Union démontable



	DÉSIGNATION	UT	CODE	PPHT (€)
264.0010.09	ROBINET BILLE PVC FF A COLLER 20	U	56620.8	20,18
264.0010.83	ROBINET BILLE PVC FF A COLLER 25	U	45479.3	21,66
264.0012.57	ROBINET BILLE PVC FF A COLLER 32	U	45480.1	25,15
264.0016.91	ROBINET BILLE PVC FF A COLLER 40	U	45482.7	33,82
264.0017.51	ROBINET BILLE PVC FF A COLLER 50	U	45483.5	35,02
264.0024.49	ROBINET BILLE PVC FF A COLLER 63	U	45485.0	48,98
264.0070.85	ROBINET BILLE PVC FF A COLLER 75	U	45487.6	141,69
264.0097.41	ROBINET BILLE PVC FF A COLLER 90	U	49629.9	194,83
251.0119.82	ROBINET BILLE PVC FF A COLLER 110	U	37172.4	239,64



VANNE A BILLE HTA

FF - Double union - 2 poignées - Avec joint EPDM chaleur



	DÉSIGNATION	UT	CODE	PPHT (€)	ECOPART (€)
260.0082.61	ROBINET A BILLE DBLE FF 25 HTA GIRPI VHCEP25	U	88334.8	127,10	0,01
260.0094.78	ROBINET A BILLE DBLE FF 32 HTA GIRPI VHCEP32	U	88337.1	145,82	
260.0118.31	ROBINET A BILLE DBLE FF 40 HTA GIRPI VHCEP40	U	88340.5	182,03	0,02
260.0176.81	ROBINET A BILLE DBLE FF 63 HTA GIRPI VHCEP63	U	88346.2	272,05	0,04

ROBINETTERIE BATIMENT

VANNE PAPILLON FONTE



ROBINET A PAPILLON A OREILLES DE CENTRAGE

Col long - Manchette EPDM - Commande levier - Génie climatique - 1170 - Corps fonte - Papillon fonte/époxy



	DÉSIGNATION	UT	CODE	PPHT (€)	ECOPART (€)
430.0081.56	VANNE PAP.OR.CENT.FTE MCH.EPDM DN65 1170065	U	4516N.1	108,82	0,07
430.0096.55	VANNE PAP.OR.CENT.FTE MCH.EPDM DN80 1170080	U	4516S.3	128,81	0,08
430.0128.12	VANNE PAP.OR.CENT.FTE MCH.EPDM DN100 1170100	U	4516X.2	170,93	0,11
430.0173.77	VANNE PAP.OR.CENT.FTE MCH.EPDM DN125 1170125	U	45179.9	231,83	0,14

AUTRE ROBINETTERIE



BOUCHON SYMETRIQUE GUILLEMIN

Avec verrou et chaînette



	DÉSIGNATION	UT	CODE	PPHT (€)
372.0041.18	BOUCHON SYM.+VERROU+CHAINE ALU 65	U	15475.7	41,18
372.0051.13	BOUCHON SYM.+VERROU+CHAINE ALU 80	U	15476.5	51,13



RACCORD SYMETRIQUE

Demi-raccord symétrique avec verrou alu - Mâle



	DÉSIGNATION	UT	CODE	PPHT (€)
372.0030.33	DEMI-RACC.SYM.+VERROU MALE ALU 40-40X49	U	15477.3	30,33
372.0039.18	DEMI-RACC.SYM.+VERROU MALE ALU 50-50X60	U	15480.7	39,18
372.0051.90	DEMI-RACC.SYM.+VERROU MALE ALU 65-66X76	U	15482.3	51,90



RACCORD SYMETRIQUE

Demi-raccord symétrique avec verrou alu - Femelle



	DÉSIGNATION	UT	CODE	PPHT (€)
372.0019.59	DEMI-RACC.SYM.+VERROU FEM.ALU 40-40X49	U	15590.3	39,18
372.0052.33	DEMI-RACC.SYM.+VERROU FEM.ALU 50-50X60	U	15592.9	52,33
372.0076.63	DEMI-RACC.SYM.+VERROU FEM.ALU 65-66X76	U	15601.8	76,63

ROBINETTERIE BATIMENT

AUTRE ROBINETTERIE



ROBINET DE PUISAGE

SKY à levier - Système breveté anti gel et anti-goutte



	DÉSIGNATION	UT	CODE	PPHT (€)
000.0042.78	ROBINET SKY LAITON LEVIER 1/2" 1750G404	U	9732W.1	57,04
000.0031.99	ROBINET DE PUISAGE ANTIGEL SKY 1/2" 1750P404	U	97332.1	42,65



VANNE A SIMPLE OPERCULE

FF cylindrique - Corps bronze - Chapeau, axe et opercule laiton - 146 - Etanchéité à l'axe par 2 joints toriques



	DÉSIGNATION	UT	CODE	PPHT (€)	ECOPART (€)
430.0024.14	VANNE OPERCULE MONOBLOC BRZE FF 1/2" 146004	U	41748.5	32,19	
430.0028.04	VANNE OPERCULE MONOBLOC BRZE FF 3/4" 146005	U	41752.7	37,39	0,01
430.0037.19	VANNE OPERCULE MONOBLOC BRZE FF 1" 146006	U	41755.0	49,60	0,01
430.0052.78	VANNE OPERCULE MONOBLOC BRZE FF 1"1/4 146007	U	41756.8	70,39	0,01
430.0076.27	VANNE OPERCULE MONOBLOC BRZE FF 1"1/2 146008	U	41758.4	101,71	0,02
430.0108.63	VANNE OPERCULE MONOBLOC BRZE FF 2" 146009	U	41759.2	144,86	0,02

COMPTAGE ET DETENTE



COMPTEUR D'EAU

Tube d'attente MM - Plastique



	DÉSIGNATION	UT	CODE	PPHT (€)
430.0009.42	TUBE ATTENTE PLAST. COMPTEUR L.110 MM20X27	U	76524.8	12,56
430.0011.28	TUBE ATTENTE PLAST. COMPTEUR L.170 MM20X27	U	76525.5	15,04



MANOMETRE

116 - Chauffage - Boîtier ABS sec - EN837-1 - Ø 63 - RA 1/4"



	DÉSIGNATION	UT	CODE	PPHT (€)
430.0010.37	MANOMETRE SEC AXIAL DN63 RA 1/4 4B 1163RA12D	U	60500.6	13,83
430.0012.98	MANOMETRE SEC AXIAL DN63 RA 1/4 6B 1163RA13D	U	60524.6	17,31
430.0010.37	MANOMETRE SEC AXIAL DN63 RA 1/4 10B 1163RA14D	U	60565.9	13,83
430.0010.98	MANOMETRE SEC AXIAL DN63 RA 1/4 16B 1163RA15D	U	60580.8	14,64

Le PPHT comprend l'ecopart (€)

ROBINETTERIE BATIMENT

COMPTAGE ET DETENTE



MANOMETRE

116 - Chauffage - Boîtier ABS sec - EN837-1 - ø 63 - RV 1/4"



	DÉSIGNATION	UT	CODE	PPHT (€)
430.0010.40	MANOMETRE SEC DN63-RV 1/4 0/4 B 1163RV12D	U	39970.9	13,86
430.0010.86	MANOMETRE SEC DN63-RV 1/4 0/6 B 1163RV13D	U	39981.6	14,48
430.0010.16	MANOMETRE SEC DN63-RV 1/4 0/10B 1163RV14D	U	39989.9	13,55
430.0010.16	MANOMETRE SEC DN63-RV 1/4 0/16B 1163RV15D	U	40017.6	13,55



MANOMETRE

116 - Chauffage - Boîtier ABS sec - EN837-1 - ø 80 - RV 1/2"



	DÉSIGNATION	UT	CODE	PPHT (€)
430.0024.86	MANOMETRE SEC DN80-RV 1/2 4B 1164RV12D	U	60610.3	33,14
430.0021.74	MANOMETRE SEC DN80-RV 1/2 0/6 B 1164RV13D	U	40051.5	28,98
430.0021.74	MANOMETRE SEC DN80-RV 1/2 0/10B 1164RV14D	U	40062.2	28,99



MANOMETRE

Bain de glycérine - Chauffage - Boîtier inox - EN837-1 - ø 63 - RV 1/4"



	DÉSIGNATION	UT	CODE	PPHT (€)
430.0015.29	MANOMETRE GLYCERINE D.63 RV 1/4 6B 2163RV13D	U	66012.6	20,39
430.0018.64	MANOMETRE GLYCERINE D.63 RV 1/4 10B 2163RV14D	U	66017.5	24,85
430.0015.29	MANOMETRE GLYCERINE D.63 RV 1/4 16B 2163RV15D	U	66021.7	20,39
430.0015.29	MANOMETRE GLYCERINE D.63 RV 1/4 25B 2163RV16D	U	60379.5	20,39



MANOMETRE

Bain de glycérine - Chauffage Industrie - Boîtier inox - EN837-1 - ø 100 - RV 1/2"



	DÉSIGNATION	UT	CODE	PPHT (€)
430.0042.69	MANOMETRE GLYC.D.100 RV1/2 10B 2165RV14D	U	66006.8	56,92
430.0042.69	MANOMETRE GLYC.D.100 RV1/2 0/16B 2165RV15	U	66009.2	56,92

ROBINETTERIE BATIMENT

COMPTAGE ET DETENTE



MANOMETRE

MANOPI - Manomètre piscine - D.50



	DÉSIGNATION	UT	CODE	PPHT (€)
430.0011.96	MANOMETRE PISC.SEC DN50 RV 1/4"0/2.5B MANOPI	U	9451J.5	15,95



MANOMETRE

MIOPRESS - Chauffage Piscine - Standard - Boîtier inox



	DÉSIGNATION	UT	CODE	PPHT (€)
430.0038.13	MANOMETRE CONTROLE PRESSION EAU0/10B MIOPRESS	U	1555K.5	50,84



MANOMETRE

Vazpress - Chauffage - Pour le contrôle des vases d'expansion - ø 50 - Avec tuyau souple 15 cm et prise rapide



	DÉSIGNATION	UT	CODE	PPHT (€)
430.0036.24	MANOMETRE A TUBE MANOMETRIQUE D.50 VAZPRESS	U	6087A.1	48,32



RACCORD COMPTEUR

MF - Avec plats et trou - D104



	DÉSIGNATION	UT	CODE	PPHT (€)
375.0044.49	RACCORD COMPT.AV.PLAT+TROU1"-1" D104025	U	4828E.1	59,32



RACCORD COMPTEUR

MF - Avec plats - D100/107



	DÉSIGNATION	UT	CODE	PPHT (€)
375.0016.01	RACCORD COMPT.1/2M-1/2EC.TOUR. D107015	U	69712.8	16,01

ROBINETTERIE BATIMENT

COMPTAGE ET DETENTE



REDUCTION DE PRESSION

A membrane réglable, arrivée mâle, sortie écrou prisonnier - 3003



	DÉSIGNATION	UT	CODE	PPHT (€)	ECOPART (€)
430.0035.33	REDUCTEUR PRESSION MF 3/4" GRK 3003-4G	U	4534B.3	58,89	0,01

Honeywell Home

REGULATEUR DE PRESSION

Clapet équilibré - Corps laiton prise manomètre en aval - D05FS - 1.5 à 6 bar - Pression jusqu'à 25 bars



	DÉSIGNATION	UT	CODE	PPHT (€)
431.0095.21	REGULATEUR PRESSION F.1/2 M.3/4 D05FS-1/2EF	U	6713U.4	146,48



ROBINET DE COMPTEUR A BOISSEAU SPHERIQUE

Robinet droit PEHD/Écrou - type 4102



	DÉSIGNATION	UT	CODE	PPHT (€)
430.0033.07	ROBINET CPT.DRT.4102 DN15 25X3/4" 212040	U	26109.9	44,09



REDUCTEUR DE PRESSION D'EAU

Isobar + CC Version composite - Eau froide/eau chaude - Sans raccord



	DÉSIGNATION	UT	CODE	PPHT (€)	ECOPART (€)
431.0104.99	REDUCTEUR PRESSION ISOBAR+CC 26X34 ISO26FCCMG	U	3102F.8	174,99	0,01
431.0060.37	REDUCTEUR ISOBAR+ MG20 FF3/4" COMP ISO20FCCMG	U	6404C.3	100,63	0,01



REDUCTEUR DE PRESSION

RINOX PLUS Série 2909 Smart M



	DÉSIGNATION	UT	CODE	PPHT (€)
431.0153.31	REDUCTEUR PRESS.RINOXPLUS SM.M 1" 29090600	U	2157M.1	204,41
431.0305.64	REDUCTEUR PRESS.RINOXPLUS SM.M 1"1/4 29090700	U	2157N.9	407,52
431.0438.74	REDUCTEUR PRESS.RINOXPLUS SM.M 1"1/2 29090800	U	2157P.7	584,99
431.0562.26	REDUCTEUR PRESS.RINOXPLUS SM.M 2" 29090900	U	2157Q.5	749,68

ROBINETTERIE BATIMENT

COMPTAGE ET DETENTE

DIEHL

Metering

COMPTEUR D'EAU

ALTAIR V4 - Compteur volumétrique et vitesse - Corps laiton eau chaude - R160



	DÉSIGNATION	UT	CODE	PPHT (€)
431.0425.10	COMPTEUR ALTAIR V4 R160 CH.40/300 3070619	U	253GG.3	566,80

DIEHL

Metering

COMPTEUR D'EAU

ALTAIR V4 - Compteur volumétrique et vitesse - Corps laiton eau froide- MID



	DÉSIGNATION	UT	CODE	PPHT (€)
650.0103.60	COMPTEUR ALTAIR V4 R160TGPI FR.15/110 3035019	U	1056Y.2	103,60
431.0078.98	COMPTEUR ALTAIR V4 R160TGPI FR.20/190 3060028	U	168SU.1	105,30
431.0294.45	COMPTEUR ALTAIR V4 R160 FR.TGVI DN25 3081896	U	280N5.3	392,60

DIEHL

Metering

COMPTEUR D'EAU

ARIES - Compteur divisionnaire à jet unique - Eau froide - MID



	DÉSIGNATION	UT	CODE	PPHT (€)
431.0030.71	COMPTEUR ARIES R125 TGPI FRD 15/110 3090790	U	210CR.8	40,95

DIEHL

Metering

COMPTEUR D'EAU

ARIES - Compteur divisionnaire à jet unique - Eau chaude - MID



	DÉSIGNATION	UT	CODE	PPHT (€)
431.0040.95	COMPTEUR ARIES R125 TGPI CHD 15/110 3090792	U	210CW.7	40,95

DIEHL

Metering

COMPTEUR D'EAU

Emetteur d'impulsions IZAR PULSE I - V5



	DÉSIGNATION	UT	CODE	PPHT (€)
431.0064.35	EMETTEUR IMPULS.IZAR PULSE I V5 3FILS 3080041	U	221AF.8	85,80

Le PPHT comprend l'ecopart (€)

ROBINETTERIE BATIMENT

COMPTAGE ET DETENTE

DIEHL
Metering

COMPTEUR D'EAU

ALTAIR V4- Compteur d'eau volumétrique



	DÉSIGNATION	UT	CODE	PPHT (€)
431.0319.80	COMPTEUR ALTAIR V4 R160 TGV1 DN32 FD 3114352	U	39408.9	426,40

SOCCLA
A WATTS Brand

DETEDEUR DE PRESSION D'EAU

FF - Alimentation eau individuelle - Bronze - 10BIS - Plage réglage aval : 1 à 6 bar



	DÉSIGNATION	UT	CODE	PPHT (€)
431.0222.48	REDUCTEUR PRESSION FF 3/4" 10BIS 149B7005	U	66298.1	296,64
431.0309.94	REDUCTEUR PRESSION FF 1" 10BIS 149B7006	U	66270.0	413,25
431.0571.48	REDUCTEUR PRESSION FF 1"1/4 10BIS 149B7007	U	66271.8	761,98
431.0805.38	REDUCTEUR PRESSION FF 1"1/2 10BIS 149B7008	U	66272.6	1073,84
431.1119.95	REDUCTEUR PRESSION FF 2" 10BIS 149B7009	U	66273.4	1493,27
431.1857.76	REDUCTEUR PRESSION FF 2"1/2 10BIS 149B7011	U	66357.5	2477,01

SOCCLA
A WATTS Brand

DETEDEUR DE PRESSION D'EAU

FF - Appartement/pavillon - Corps bronze - 11BIS - Plage de réglage aval : de 1 à 5,5 bar



	DÉSIGNATION	UT	CODE	PPHT (€)
431.0140.30	REDUCTEUR PRESSION FF 1/2 11BIS 149B7056	U	15254.6	187,06
431.0184.76	REDUCTEUR PRESSION FF 3/4 11BIS 149B7057	U	15255.3	246,34

SOCCLA
A WATTS Brand

DETEDEUR DE PRESSION D'EAU

FF - Junior - Alimentation d'eau individuelle, chantiers économiques - 7BIS - Plage de réglage aval : de 1 à 5,5 bar



	DÉSIGNATION	UT	CODE	PPHT (€)
431.0058.94	REDUCTEUR PRESSION FF 1/2" 7BIS 149B7209	U	45662.4	78,59
431.0070.48	REDUCTEUR PRESSION FF 3/4" 7BIS JR 149B7210	U	45663.2	93,98
431.0130.84	REDUCTEUR PRESSION FF 1" 7BIS 149B7552	U	4473E.9	174,45
431.0232.73	REDUCTEUR PRESSION FF 1"1/4 7BIS 149B7553	U	4473F.7	310,31
431.0330.44	REDUCTEUR PRESSION FF 1"1/2 7BIS 149B7554	U	4473G.5	440,59
431.0495.75	REDUCTEUR PRESSION FF 2" 7BIS 149B7555	U	4473H.3	661,00

ROBINETTERIE BATIMENT

COMPTAGE ET DETENTE

SOCCLA
A WATTS Brand

DETEDEUR DE PRESSION D'EAU

FM - Alimentation d'eau individuelle appartement/pavillon - Corps bronze - 11EP - Plage de réglage aval : de 1 à 5,5 bar



	DÉSIGNATION	UT	CODE	PPHT (€)
431.0155.39	REDUCTEUR PRESSION 11EP FM 3/4 DN20 149B7511	U	0354C.6	258,99

SOCCLA
A WATTS Brand

DETEDEUR DE PRESSION D'EAU

FM - Junior - Alimentation d'eau individuelle, chantiers économiques - 7EP - Plage de réglage aval : de 1 à 5,5 bar



	DÉSIGNATION	UT	CODE	PPHT (€)
431.0115.35	REDUCTEUR PRESSION 7EP FM 3/4 149B7212	U	19111.4	153,80

SOCCLA
A WATTS Brand

DETEDEUR DE PRESSION D'EAU

MF - Protection d'un appareil isolé, chauffe-eau - Corps bronze chromé - 5SP - Plage de réglage aval : de 1 à 5,5 bar



	DÉSIGNATION	UT	CODE	PPHT (€)
431.0062.07	REDUCTEUR PRESSION SECURIO MF 3/4" 149B7312	U	76856.4	82,76

SOCCLA
A WATTS Brand

DETEDEUR DE PRESSION D'EAU

MM - Alimentation d'eau individuelle - Corps bronze - 10 - Plage de réglage aval : de 1 à 6 bar



	DÉSIGNATION	UT	CODE	PPHT (€)
431.0249.60	REDUCTEUR PRESSION MM 3/4" 10 149B7001	U	45588.1	332,80
431.0358.05	REDUCTEUR PRESSION MM 1" 10 149B7002	U	53945.2	477,40

SOCCLA
A WATTS Brand

DETEDEUR DE PRESSION D'EAU

MM - Alimentation d'eau individuelle appartement/pavillon - Corps bronze - 11 - Plage de réglage aval : de 1 à 5,5 bar



	DÉSIGNATION	UT	CODE	PPHT (€)
431.0157.74	REDUCTEUR PRESSION 11 MM DN15 149B7054	U	15252.0	210,32
431.0194.24	REDUCTEUR PRESSION 11 MM DN20 149B7055	U	15253.8	258,99

ROBINETTERIE BATIMENT

COMPTAGE ET DETENTE



A WATTS Brand

DETendeur DE PRESSION D'EAU

MULTI7 - Alimentation d'eau individuelle, chantiers économiques - Plage de réglage aval : de 1 bar à 5,5 bar



	DÉSIGNATION	UT	CODE	PPHT (€)
431.0107.28	REDUCTEUR PRESSION DN20 MULTI 7 3/4" 149B7540	U	68262.5	143,04



A WATTS Brand

ACCESSOIRE MANOMETRE

FM - Mamelon porte-manomètre avec prise équerre Femelle 1/4" - Corps bronze - 487



	DÉSIGNATION	UT	CODE	PPHT (€)
431.0024.52	MAMELON P.MANOMETRE FM 1/2 487 149B7179	U	52423.1	32,69
431.0028.34	MAMELON P.MANOMETRE FM 3/4 487 149B7180	U	31542.4	37,78
431.0035.02	MAMELON P.MANOMETRE FM 1 487 149B7181	U	45185.6	46,70
431.0057.35	MAMELON P.MANOMETRE FM 1"1/4 487 149B7182	U	08257.8	76,47
431.0065.61	MAMELON P.MANOMETRE FM 1"1/2 487 149B7183	U	08258.6	87,48
431.0089.60	MAMELON P.MANOMETRE FM 2" 487 149B7184	U	08259.4	119,47



A WATTS Brand

PIECES DETACHEES POUR DETendeur

Etrier complet pour détendeurs de pression 10, 10BIS et 10TER



	DÉSIGNATION	UT	CODE	PPHT (€)
431.0067.24	ETRIER COMPLET 3/4" 149B7046	U	71717.3	89,65
431.0090.86	ETRIER COMPLET 1" 149B7047	U	71718.1	121,14



SOUPAPE SANITAIRE

FF - SVW - Soupape sanitaire sortie majorée - Corps laiton - Température 140°C



	DÉSIGNATION	UT	CODE	PPHT (€)	ECOPART (€)
650.0091.41	SOUPAPE SANITAIR.F 1"-1"1/4 7B 22L0218607	U	13833.9	121,89	0,01
650.0152.10	SOUPAPE SANITAIR.F 1"1/4-1"1/2 7B 22L0219607	U	22051.7	202,81	0,01



SOUPAPE DE SURETE

FF - Soupape chauffage avec sortie majorée - Corps laiton



	DÉSIGNATION	UT	CODE	PPHT (€)	ECOPART (€)
650.0037.17	SOUPAPE CHAUFFAGE SVH30-3/4 22L0217630	U	22036.8	49,57	0,01
650.0037.17	SOUPAPE CHAUFFAGE SVW40-3/4 22L0217604	U	9847B.4	49,57	0,01
650.0085.15	SOUPAPE CHAUFFAGE SVH30-1" 22L0218630	U	22037.6	113,54	0,01

ROBINETTERIE BATIMENT

COMPTAGE ET DETENTE



SOUPAPE DE SURETE

FF - Série bronze - A ouverture instantanée à effet "POP" - Temp.de service maxi 110°C



	DÉSIGNATION	UT	CODE	PPHT (€)
650.0087.80	SOUPAPE DE SURETE 174A F 3/4" 7BAR 2226151	U	80997.0	117,06

FILTRE



FILTRE A TAMIS

FF - Corps laiton



	DÉSIGNATION	UT	CODE	PPHT (€)
430.0033.47	FILTRE A TAMIS LAITON FF 33X42	U	29608.7	44,63
430.0009.04	FILTRE A TAMIS LAITON FF 15X21	U	2959J.7	12,06
430.0015.10	FILTRE A TAMIS LAITON FF 20X27	U	2959K.5	20,13
430.0018.70	FILTRE A TAMIS LAITON FF 26X34	U	2959L.3	24,93
430.0051.24	FILTRE A TAMIS LAITON FF 40X49	U	2960D.6	68,32
430.0069.85	FILTRE A TAMIS LAITON FF 50X60	U	2960E.3	93,13



FILTRE A TAMIS

FF - Corps laiton - Avec purge ACS



	DÉSIGNATION	UT	CODE	PPHT (€)
430.0009.12	FILTRE TAMIS + PURGE ACS FF 1/2"	U	8664T.2	15,20
430.0023.57	FILTRE TAMIS + PURGE ACS FF 3/4"	U	8665I.7	23,57
430.0026.86	FILTRE TAMIS + PURGE ACS FF 1"	U	8665A.7	26,86
430.0042.93	FILTRE TAMIS + PURGE ACS FF 1"1/4	U	8665G.4	42,93
430.0047.81	FILTRE TAMIS + PURGE ACS FF 1"1/2	U	8665J.9	47,81
430.0090.19	FILTRE TAMIS + PURGE ACS FF 2"	U	8665M.3	90,19

CLAPET ET CREPINE



CLAPET DE RETENUE A BATTANT

FF - Clapet de non-retour simple battant laiton - Siège caoutchouc



	DÉSIGNATION	UT	CODE	PPHT (€)
030.0021.40	CLAPET BATTANT LAITON SIEGE CAOUT.PN16 20X27	U	72481.5	28,53
030.0031.56	CLAPET BATTANT LAITON SIEGE CAOUT.PN16 26X34	U	72482.3	42,08
030.0042.70	CLAPET BATTANT LAITON SIEGE CAOUT.PN16 33X42	U	72485.6	56,93

Le PPHT comprend l'ecopart (€)

ROBINETTERIE BATIMENT

CLAPET ET CREPINE



CLAPET ANTIPOLLUTION FF



	DÉSIGNATION	UT	CODE	PPHT (€)
430.0014.06	CLAPET ANTIPOLLUTION 15X21 FF	U	2044B.0	18,74
430.0019.28	CLAPET ANTIPOLLUTION 26X34 FF	U	2044G.9	25,70
430.0038.36	CLAPET ANTIPOLLUTION 33X42 FF	U	2044J.4	51,14
430.0063.18	CLAPET ANTIPOLLUTION 40X49 FF	U	2044L.0	84,24
430.0114.73	CLAPET ANTIPOLLUTION 50X60 FF	U	20451.1	152,97
430.0014.76	CLAPET ANTIPOLLUTION 20X27 FF	U	2043J.5	19,68



CLAPET ANTIPOLLUTION FM



	DÉSIGNATION	UT	CODE	PPHT (€)
431.0014.00	CLAPET ANTIPOLLUTION EA DN20 FM3/4 78MM	U	203CT.9	18,66
430.0015.19	CLAPET COURT ANTIPOLLUTION EA DN20 FM3/4 58MM	U	247XU.8	20,25



CLAPET OBTURATEUR ACS LAITON - TOUTES POSITIONS FF



	DÉSIGNATION	UT	CODE	PPHT (€)
430.0007.40	CLAPET OBTURATEUR LAIT.TTE POS.ACS 12X17 FF	U	165CS.2	9,86
430.0010.30	CLAPET OBTURATEUR LAIT.TTE POS.ACS 15X21 FF	U	165D0.7	13,73
430.0011.53	CLAPET OBTURATEUR LAIT.TTE POS.ACS 20X27 FF	U	165D1.5	15,37
430.0015.50	CLAPET OBTURATEUR LAIT.TTE POS.ACS 26X34 FF	U	165D2.3	20,67
430.0020.46	CLAPET OBTURATEUR LAIT.TTE POS.ACS 33X42 FF	U	165D3.1	27,28
430.0029.93	CLAPET OBTURATEUR LAIT.TTE POS.ACS 40X49 FF	U	165D4.9	39,91
430.0039.02	CLAPET OBTURATEUR LAIT.TTE POS.ACS 50X60 FF	U	165D5.6	52,02
430.0095.80	CLAPET OBTURATEUR LAIT.TTE POS.ACS 66X76 FF	U	165D6.4	127,73
430.0130.03	CLAPET OBTURATEUR LAIT.TTE POS.ACS 80X89 FF	U	165D7.2	173,37



CLAPET CREPINE - CLAPET DE PIED

Femelle - Corps laiton - Crépine laiton - Obturateur laiton - Joint NBR - Montage vertical - 304



	DÉSIGNATION	UT	CODE	PPHT (€)	ECOPART (€)
431.0015.44	CLAPET CREPINE VERT.LAIT. PN10 F.3/4" 304005	U	61070.9	20,59	0,01
431.0019.34	CLAPET CREPINE VERT.LAIT. PN10 F.1" 304006	U	61071.7	25,80	0,01
431.0028.07	CLAPET CREPINE VERT.LAIT. PN 8 F.1"1/4 304007	U	61072.5	37,44	0,01
431.0035.30	CLAPET CREPINE VERT.LAIT. PN 8 F.1"1/2 304008	U	61073.3	47,07	0,01
431.0055.73	CLAPET CREPINE VERT.LAIT. PN 8 F.2" 304009	U	61074.1	74,33	0,02

Le PPHT comprend l'ecopart (€)

ROBINETTERIE BATIMENT

DISCONNECTEUR

Honeywell Home

DISCONNECTEUR HYDRAULIQUE CONTROLABLE

A zone de pression réduite contrôlable - Avec tamis filtre amont intégré



	DÉSIGNATION	UT	CODE	PPHT (€)
680.0339.26	DISCONNECTEUR HYDR.3/4 HONEYWELL BA295S-3/4A	U	168KY.5	424,07
680.0375.05	DISCONNECTEUR HYDR.1/2 HONEYWELL BA295S-1/2A	U	168LD.5	375,05
680.0407.07	DISCONNECTEUR HYDR.CONTR.1 BA295S-1A	U	168LE.2	542,76
680.0613.62	DISCONNECTEUR HYDR.CONTR.11/4 BA295S-11/4A	U	3407X.6	818,16
431.0706.40	DISCONNECTEUR HYDRAUL.CTRL 11/2 BA295S-11/2A	U	212PW.6	941,87
431.0728.64	DISCONNECTEUR HYDRAULIQUE CONTROL.2 BA295S-2A	U	212Q1.8	971,52

Honeywell Home

DISCONNECTEUR HYDRAULIQUE NON-CONTROLABLE

A zones de pression différentes non-contrôlables - Type A avec raccord union



	DÉSIGNATION	UT	CODE	PPHT (€)
431.0080.13	DISCONNECTEUR HYDR.NON CONTR.1/2 F CA295-1/2A	U	0498B.5	114,47
431.0080.13	DISCONNECTEUR HYDR.NON CONTR.3/4F CA295-3/4A	U	04995.7	114,47



DISCONNECTEUR BA

MM - Protection des réseaux d'eau potable - Pression réduite+entonnoir - BA2860 - Ultra-compact



	DÉSIGNATION	UT	CODE	PPHT (€)
431.0517.76	DISCONNECTEUR 20X3/4 -BA 2860- 149B3881	U	3879L.8	517,76



DISCONNECTEUR CA

FF - Installation de chauffage < à 70KW - Pression réduite - CA2096 - Clapet POM et laiton



	DÉSIGNATION	UT	CODE	PPHT (€)
431.0132.60	DISCONNECTEUR CA2096 DN15 FF 1/2" 149B3781	U	4068S.5	132,60
431.0132.60	DISCONNECTEUR CA2096 DN20 FF 3/4 149B3782	U	4068U.0	132,60



DISCONNECTEUR CA-A

FF - Installation de chauffage < à 70KW - Pression réduite - Disconnecteur "compact" CA9C brut + garde d'air



	DÉSIGNATION	UT	CODE	PPHT (€)	ECOPART (€)
431.0128.46	DISCONNECTEUR CA9C +GARDE AIR FF 1/2 2230115	U	51953.8	128,47	0,01

ROBINETTERIE BATIMENT

ROBINETTERIE A CLAPET



A VISSER

FF - Sans purge



	DÉSIGNATION	UT	CODE	PPHT (€)
030.0010.58	ROBINET ARRET BRUT FF 20X27 T20	U	22387.5	14,10



ROBINET D'ARRET

MM - Avec épaulement



	DÉSIGNATION	UT	CODE	PPHT (€)
030.0007.99	ROBINET ARRET BRUT MM AVEC EPAUL. 15X21	U	22350.3	10,65
030.0010.80	ROBINET ARRET BRUT MM AVEC EPAUL. 20X27	U	22356.0	14,40



ROBINET DE PUISAGE RAN

Mâle - Robinet d'arrosage



	DÉSIGNATION	UT	CODE	PPHT (€)
430.0009.32	ROBINET ARROSAGE RAN BRUT 15 15/20 T15	U	22695.1	12,42
030.0012.36	ROBINET ARROSAGE RAN BRUT 18 20/20 T15	U	74104.1	16,48
030.0017.18	ROBINET ARROSAGE RAN BRUT 20 20/20	U	07965.7	22,90
030.0016.42	ROBINET ARROSAGE RAN BRUT 20 20/26 T20	U	22698.5	21,90



ROBINET AVANT COMPTEUR

Mâle - Sans épaulement - Avec écrou



	DÉSIGNATION	UT	CODE	PPHT (€)
030.0009.86	ROBINET AV.COMPTEUR BRUT MALE 15X21EGR20X27	U	09213.0	16,44
030.0011.54	ROBINET AV.COMPTEUR BRUT MALE 20X27	U	54999.8	15,39



VANNE DE PUISAGE

A bec - Poli



	DÉSIGNATION	UT	CODE	PPHT (€)
030.0018.10	ROBINET DE PUISAGE POLI A BEC 15X21 T15	U	22634.0	21,29

ROBINETTERIE BATIMENT

ROBINETTERIE A CLAPET



TETE DE ROBINET A CLAPET

Tête à potence - Normalisée - Laiton poli



	DÉSIGNATION	UT	CODE	PPHT (€)
030.0005.01	TETE ROB.POTENCE POLI 12X17	U	55860.1	6,68
030.0008.12	TETE ROB.POTENCE POLI 20X27	U	55867.6	10,83
030.0007.39	TETE ROB.POTENCE POLI 15X21	U	64835.2	8,21
030.0023.67	TETE ROB.POTENCE BRUT 26X34	U	17793.1	31,56



TETE DE ROBINET A CLAPET

Tête cache entrée - Brut



	DÉSIGNATION	UT	CODE	PPHT (€)
030.0005.78	TETE ROB.CACHE ENTREE BRUT 12X17	U	73367.5	7,70
030.0005.78	TETE ROB.CACHE ENTREE BRUT 15X21	U	73369.1	7,70
030.0007.58	TETE ROB.CACHE ENTREE BRUT 20X27	U	73370.9	10,10



ROBINET D'ARROSAGE

70 - Robinet Chromé



	DÉSIGNATION	UT	CODE	PPHT (€)	ECOPART (€)
430.0036.32	ROBINET ARROSAGE 15/20 CHR GRK 70-5FG	U	1524C.9	60,54	0,01



ROBINET D'ARROSAGE

71 - Avec tête cache-entrée - Grenailé



	DÉSIGNATION	UT	CODE	PPHT (€)	ECOPART (€)
430.0017.56	ROBINET ARROSAGE 1/2"-3/4" +TC GRK 71-8FG	U	4335B.4	29,28	0,01



ROBINET D'ARROSAGE

70 - Tête Taplock Magnétique



	DÉSIGNATION	UT	CODE	PPHT (€)	ECOPART (€)
000.0044.45	ROBINET TETE TAPLOCK MAGNETIQUE N205 70-8FG15	U	8612E.2	111,14	0,01

Le PPHT comprend l'ecopart (€)

ROBINETTERIE BATIMENT

ROBINETTERIE A CLAPET



L'eau approuvée

TETE DE ROBINET

Clé pour tête cache-entrée - Brute



	DÉSIGNATION	UT	CODE	PPHT (€)	ECOPART (€)
430.0009.12	CLE P.TETE CACHE ENTREE 3/8 A 3/4 GRK 183-1F	U	43958.1	15,21	0,01



ROBINET D'ARROSAGE

Mâle - Avec raccord au nez - Conditionnement : sachet



	DÉSIGNATION	UT	CODE	PPHT (€)	ECOPART (€)
430.0017.99	ROBINET ARROSAGE 1/2" + NEZ 1/2" 136901	U	172E3.6	24,00	0,01



TETE CACHE-ENTREE

Clé pour tête cache-entrée



	DÉSIGNATION	UT	CODE	PPHT (€)	ECOPART (€)
430.0005.57	CLE C ENTREE 3/8-3/4 136696	U	4062D.9	5,58	0,01



TETE DE ROBINET

Tête de robinet à potence - Laiton brut



	DÉSIGNATION	UT	CODE	PPHT (€)	ECOPART (€)
430.0006.38	TETE DE ROBINET A POTENCE 23/150 136879	U	54864.4	14,18	0,01

ACCESSOIRES ET EQUIPEMENT SANITAIRE



ANTIBELIER

Femelle - A ressort



	DÉSIGNATION	UT	CODE	PPHT (€)
430.0021.74	ANTIBELIER A RESSORT FEMELLE 15X21	U	79439.6	36,24
430.0026.89	ANTIBELIER A RESSORT FEMELLE 20X27	U	79447.9	35,85
430.0025.94	ANTIBELIER A RESSORT FEMELLE 26X34	U	00804.5	43,24
430.0064.37	ANTIBELIER A RESSORT FEMELLE 33X42	U	20636.7	85,83
430.0067.19	ANTIBELIER A RESSORT FEMELLE 40X49	U	20637.5	89,59

ROBINETTERIE BATIMENT

ACCESSOIRES ET EQUIPEMENT SANITAIRE



ANTIBELIER

Mâle - A ressort



	DÉSIGNATION	UT	CODE	PPHT (€)
430.0027.18	ANTIBELIER A RESSORT MALE 15X21	U	67688.2	36,24
000.0026.89	ANTIBELIER A RESSORT MALE 20X27	U	67692.4	35,85
430.0032.43	ANTIBELIER A RESSORT MALE 26X34	U	67698.1	43,24



APPLIQUE

Nue - Chromé



	DÉSIGNATION	UT	CODE	PPHT (€)
000.0002.48	APPLIQUE NUE CHROME 15X21 15X21	U	22786.8	3,30



APPLIQUE

Nue - Brut



	DÉSIGNATION	UT	CODE	PPHT (€)
030.0002.09	APPLIQUE BR. AVEC ECROU 14 2002811601400	U	22768.6	2,79
030.0006.30	APPLIQUE NUE BRUT 20X27 20X27	U	60220.1	8,40



ROBINET D'ARRET

MM - Pour machine à laver - Simple



	DÉSIGNATION	UT	CODE	PPHT (€)
430.0004.77	ROBINET M.A.L.EQUERRE S/RAN M CROIS.CHR 15/20	U	17882.2	6,36



ROBINET D'ARRET

MM - Pour machine à laver - Double - Sans raccord au nez



	DÉSIGNATION	UT	CODE	PPHT (€)
430.0032.06	ROB.M.A.L.DBLE+LV S/RAN M CROIS. CHR 15/20	U	64523.4	42,75

Le PPHT comprend l'ecopart (€)

ROBINETTERIE BATIMENT

ACCESSOIRES ET EQUIPEMENT SANITAIRE



ROBINET D'ARRET

Mâte - Pour machine à laver - Auto-perceur - Pour tube ø 10 à ø 16 mm - Conditionné sous blister



DÉSIGNATION	UT	CODE	PPHT (€)
ROBINET M.A.L AUTO-PERCEUR -BLISTER- 10-16MM	U	41225.4	22,02



RALLONGE MF



DÉSIGNATION	UT	CODE	PPHT (€)
RALLONGE DE ROBINET POLIE 15X21 25	U	71558.1	23,65
RALLONGE DE ROBINET POLIE 15X21 50	U	64804.8	29,34
RALLONGE DE ROBINET POLIE 20X27 50	U	25504.2	22,84
RALLONGE DE ROBINET POLIE 20X27 100	U	16436.8	64,80



ROBINET STAR M.A.L

PN40 avec levier alu chromé



DÉSIGNATION	UT	CODE	PPHT (€)
ROBINET M.A.L STAR PN40 1/2 1720C404	U	6217J.6	27,31



ROBINET FLOTTEUR



DÉSIGNATION	UT	CODE	PPHT (€)	ECOPART (€)
ROBINET FLOTTEUR 3/4" GRK 30-8G	U	54826.1	32,44	0,01
ROBINET FLOTTEUR 1" GRK 30-8H	U	54821.7	46,38	0,01



ROBINET FLOTTEUR

Boule Flotteur



DÉSIGNATION	UT	CODE	PPHT (€)	ECOPART (€)
BOULE PLASTIQUE ROB.FLOTTEUR D.180 GRK 32-1G	U	353PC.7	13,28	0,01

ROBINETTERIE BATIMENT

ACCESSOIRES ET EQUIPEMENT SANITAIRE

hansgrohe

MOUSSEUR

Pour lavabo et bidet - EcoSmart : Waterdimmer limitant le débit à 5 L/min



DÉSIGNATION	UT	CODE	PPHT (€)
MOUSSEUR LAV.BIDET ECO-PAIRE-H.GROHE 13958002	U	29617.8	18,11



TETE DE ROBINET

Tête de robinet de remplacement à croisillon métal - Profondeur du siège : de 16 mm à 34 mm



DÉSIGNATION	UT	CODE	PPHT (€)	ECOPART (€)
TETE UNIVERSELLE MINITET 12X17 0103001	U	74916.8	20,72	0,02
TETE UNIVERSELLE MINITET 18X150 0103003	U	76435.7	20,72	0,02
TETE UNIVERSELLE MINITET 19X150 0103004	U	74918.4	20,72	0,02
TETE UNIVERSELLE MINITET 20X150 0103005	U	74919.2	20,72	0,02
TETE UNIVERSELLE MINITET 15X21 0103008	U	76432.4	20,72	0,02



CACHE-TROU



DÉSIGNATION	UT	CODE	PPHT (€)	ECOPART (€)
CACHE TROU D.50MM ZAMAK CHR PELLET 007161	U	319RZ.2	11,66	0,01



EQUIPEMENT MACHINE A LAVER

Couronne PVC souple - Arrivée droite sortie coudée 20/27



DÉSIGNATION	UT	CODE	PPHT (€)
FLEXIBLE ALIM.T.M.A.L 1M50 REGIPLAST TAMAL15	U	03304.3	5,00
FLEXIBLE ALIM.T.M.A.L 2M50 REGIPLAST TAMAL25	U	294Y1.8	6,75



RACCORD

MM - Applique - Embase 52mm



DÉSIGNATION	UT	CODE	PPHT (€)	ECOPART (€)
APPLIQUE SANITAIRE MALE 3/4 1/2 07020	U	8588V.0	15,16	0,01

Le PPHT comprend l'ecopart (€)

ROBINETTERIE BATIMENT

ACCESSOIRES ET EQUIPEMENT SANITAIRE



RACCORD

MF - Colonnnette - Luxe avec flexible intégré
50 cm



	DÉSIGNATION	UT	CODE	PPHT (€)	ECOPART (€)
375.0121.37	COLONNETTE LUXE M3/4+FLEX.FF1/2 RIOQUIER 71582	U	2603D.9	151,74	0,03



RACCORD

MM - Colonnnette - Luxe monobloc
fondue



	DÉSIGNATION	UT	CODE	PPHT (€)	ECOPART (€)
700.0019.78	COLONNETTE LUXE MM 3/4-1/2 RIOQUIER 07168	U	5108G.5	24,73	0,01



ROBINET DE CHASSE

MF - Robinet équerre avec presse-étoupe



	DÉSIGNATION	UT	CODE	PPHT (€)	ECOPART (€)
430.0005.96	ROBINET CHASSE EQ.PRESS.ETOUPE 3/8 CHR 03921	U	9255O.1	7,46	0,01
430.0005.59	ROBINET CHASSE EQ.PRESS.ETOUPE 3/8 BRUT 03920	U	2090L.2	7,00	0,01



EQUIPEMENT MACHINE A LAVER

MM - Robinet - 1332 - Tête laiton chromé -
Modèle lourd



	DÉSIGNATION	UT	CODE	PPHT (€)	ECOPART (€)
430.0022.54	ROBINET MAL CONFORT 1/2 1332004	U	94953.7	30,07	0,01



EQUIPEMENT MACHINE A LAVER

MM - Robinet - 1326 - Avec applique
incorporée ø 55 mm



	DÉSIGNATION	UT	CODE	PPHT (€)	ECOPART (€)
430.0021.88	ROBINET MAL APPLIQUE MONOBLOC CHR 1/2 1326004	U	55621.7	29,18	0,01



CLAPET - FILTRE

MM - Thermogel - Soupape antigel avec
cartouche thermostatique et clapet anti-vidé



	DÉSIGNATION	UT	CODE	PPHT (€)
653.0085.20	SOUPAPE ANTIGEL RACC.MM 1" 10B 108601 CA26M	U	12857.9	142,00
653.0096.00	SOUPAPE ANTIGEL 1"1/4 10B 108701 CA33M	U	3246N.0	160,00

Le PPHT comprend l'ecopart (€)

ROBINETTERIE BATIMENT

ACCESSOIRES ET EQUIPEMENT SANITAIRE



MINI-VANNE

MF à écrou tournant - Raccord "R" -
A écrou tournant



	DÉSIGNATION	UT	CODE	PPHT (€)	ECOPART (€)
430.0013.24	RACCORD "R" ECRU TOURNANT M3/8" 329506	U	4714R.5	22,07	0,01
430.0013.67	RACCORD "R" ECRU TOURNANT M1/2" 329509	U	4714T.1	22,79	0,01

FLEXIBLE DE RACCORDEMENT



ACCESSOIRES POUR MACHINES A LAVER

Canne de vidange - Annelée avec crose
amovible



	DÉSIGNATION	UT	CODE	PPHT (€)
754.0003.42	CANNE DE VIDANGE MAL 1M50 REGIPLAST CVMAL15	U	21666.3	4,28
754.0004.66	CANNE DE VIDANGE MAL 2M50 REGIPLAST CVMAL25	U	294Y5.9	5,82



SANITAIRE - TRESSE INOX

FF - TAQ - Flexible en acier inoxydable - Diamètre
intérieur : 8 mm



	DÉSIGNATION	UT	CODE	PPHT (€)
430.0003.17	FLEXIBLE INOX DROIT P08 F3/8XF3/8 30CM 2562	U	4474L.5	4,23
430.0004.15	FLEXIBLE INOX DROIT P08 F3/8XF3/8 50CM 3622	U	44751.6	5,53
430.0005.67	FLEXIBLE INOX DROIT P08 F3/8XF3/8 80CM 1117	U	44751.9	7,56
430.0006.80	FLEXIBLE INOX DROIT P08 F3/8XF3/8 100CM 4305	U	44756.5	9,06
430.0003.75	FLEXIBLE INOX DROIT P08 F1/2XF1/2 30CM 3618	U	44756.3	5,00
430.0004.64	FLEXIBLE INOX DROIT P08 F1/2XF1/2 50CM 3623	U	4475H.1	6,19
430.0006.69	FLEXIBLE INOX DROIT P08 F1/2XF1/2 80CM 3954	U	4475J.8	8,92
430.0007.69	FLEXIBLE INOX DROIT P08 F1/2XF1/2 100CM 3955	U	4475K.6	10,25



SANITAIRE - TRESSE INOX

FF - Extra twist HG



	DÉSIGNATION	UT	CODE	PPHT (€)
430.0021.68	FLEXIBLE INOX TWIST FF HG-1-500 P25 204729	U	5397S.4	28,91
430.0026.64	FLEXIBLE INOX TWIST FF HG-1-700 P25 204731	U	5398K.7	35,52
430.0031.13	FLEXIBLE INOX TWIST FF HG-1-1000 P25 204734	U	5398R.5	41,51
430.0040.32	FLEXIBLE INOX TWIST FF HG-11/4-500 P30 204753	U	53998.1	53,76
430.0055.20	FLEXIBLE INOX TWIST FF HG-11/4-1000P30 204758	U	5399B.4	73,60
430.0090.25	FLEXIBLE INOX TWIST FF HG-11/2-500 P40 204777	U	5399C.2	120,33
430.0115.47	FLEXIBLE INOX TWIST FF HG-11/2-1000P40 204782	U	5399E.7	153,96
430.0121.90	FLEXIBLE INOX TWIST FF HG-2-500 P50 204801	U	5399N.0	162,54

ROBINETTERIE BATIMENT

FLEXIBLE DE RACCORDEMENT



SANITAIRE - TRESSE INOX

MF - TAQ - Flexible en acier inoxydable - Diamètre intérieur : 8 mm



	DÉSIGNATION	UT	CODE	PPHT (€)
430.0003.41	FLEXIBLE INOX DROIT P08 F3/8XM3/8 15CM 6431	U	44759.9	4,55
430.0003.31	FLEXIBLE INOX DROIT P08 F3/8XM3/8 30CM 2203	U	4475C.2	4,41
430.0004.62	FLEXIBLE INOX DROIT P08 F3/8XM3/8 50CM 4211	U	4475D.0	6,16
430.0003.75	FLEXIBLE INOX DROIT P08 M1/2XF1/2 30CM 1863	U	5888C.0	5,00
430.0004.98	FLEXIBLE INOX DROIT P08 F1/2XM1/2 50CM 1865	U	44788.8	6,64
430.0007.74	FLEXIBLE INOX DROIT P08 M1/2XF1/2 80CM 1499	U	59416.6	10,32



SANITAIRE - TRESSE INOX

MF - TAQ GRIF - Flexible en acier inoxydable - Diamètre intérieur : 8 mm - L 17



	DÉSIGNATION	UT	CODE	PPHT (€)
430.0005.62	FLEXIBLE INOX GRIF.F3/8 M10X100 L17 30CM 5962	U	6115F.6	7,03



PLOMBERIE-CLIMATISATION - TRESSE INOX

FF - TAQ Super - Flexible en acier inoxydable - Diamètre intérieur : 13 mm



	DÉSIGNATION	UT	CODE	PPHT (€)
430.0008.24	FLEXIBLE INOX SUPER P13 FF1/2 30CM 5704	U	4476E.6	10,99
430.0009.42	FLEXIBLE INOX SUPER P13 FF1/2 50CM 1432	U	4476F.4	12,56
430.0013.25	FLEXIBLE INOX SUPER P13 FF1/2 80CM 5461	U	5932L.8	17,67
430.0015.62	FLEXIBLE INOX SUPER P13 FF1/2 100CM 5493	U	4476G.2	20,82
430.0009.10	FLEXIBLE INOX SUPER P13 FF3/4 30CM 5708	U	4476H.0	12,14
430.0011.02	FLEXIBLE INOX SUPER P13 FF3/4 50CM 1439	U	4476J.7	14,70
430.0015.86	FLEXIBLE INOX SUPER P13 FF3/4 100CM 5494	U	4476K.5	21,14



PLOMBERIE-CLIMATISATION - TRESSE INOX

FF - TAQ Super Codo - Flexible en acier inoxydable - Diamètre intérieur : 13 mm



	DÉSIGNATION	UT	CODE	PPHT (€)
430.0029.08	FLEXIBLE INOX SUPER COUDE P13 F3/4 150CM 6433	U	4477G.1	38,78



CHAUFFAGE-CLIMATISATION - TRESSE INOX

FF - TAQ Extra - Flexible en acier inoxydable



	DÉSIGNATION	UT	CODE	PPHT (€)
430.0013.46	FLEXIBLE INOX EXTRA P19 FF3/4 50CM 6621	U	4477H.9	17,95
430.0018.71	FLEXIBLE INOX EXTRA P19 FF3/4 70CM 6622	U	4480G.6	24,95

ROBINETTERIE BATIMENT

FLEXIBLE DE RACCORDEMENT



CHAUFFAGE-CLIMATISATION - TRESSE INOX

FF - TAQ Extra - Flexible en acier inoxydable - suite



	DÉSIGNATION	UT	CODE	PPHT (€)
430.0023.10	FLEXIBLE INOX EXTRA P19 FF3/4 100CM 1107	U	4477I.7	30,80
430.0116.13	FLEXIBLE INOX EXTRA P40 FF11/2 100CM 2499	U	4478C.9	154,84



CHAUFFAGE-CLIMATISATION - TRESSE INOX

FF - TAQ Extra Codo - Flexible coude en acier inoxydable



	DÉSIGNATION	UT	CODE	PPHT (€)
430.0041.76	FLEXIBLE INOX EXTRA CODO P19 FF3/4 100CM 6711	U	59411.9	55,68

RACCORD D'ARROSAGE



RACCORD EXPRESS

Joint de rechange pour raccord express - Caoutchouc



	DÉSIGNATION	UT	CODE	PPHT (€)
372.0000.50	JOINT CAOUTCHOUC NOIR POUR RACCORD EXPRESS	U	12938.7	0,84



RACCORD

FMM - Y écrou tournant - D648



	DÉSIGNATION	UT	CODE	PPHT (€)
375.0030.29	RACCORD Y ECR.TOURN.F3/4"-M3/4" M3/4" D64803B	U	9679B.7	55,07

BOUCHE D'ARROSAGE



BOUCHE PVC

MF - Carré - Avec robinet 1/4 de tour



	DÉSIGNATION	UT	CODE	PPHT (€)	ECOPART (€)
257.0082.36	BOUCHE ARROSAGE ROB.1/4T.M3/4XF3/4 VT BAC227	U	39359.5	109,83	0,02

Le PPHT comprend l'ecopart (€)

ROBINETTERIE BATIMENT

BOUCHE D'ARROSAGE



BOUCHE PVC

MF - Modèle standard avec robinet tête à potence -
Ovale - Passage de 15



	DÉSIGNATION	UT	CODE	PPHT (€)	ECOPART (€)
257.0119.66	BOUCHE ARROSAGE ROB.A.POTENCE 3/4" BRM2027	U	61154.1	159,56	0,02

JOINT D'ETANCHEITE

WATTS
JOINT FIBRE
Sirius®



	DÉSIGNATION	UT	CODE	PPHT (€)	ECOPART (€)
920.0003.44	JOINT FIBRE RACCORD STAND.12/17 1011098	U	49029.2	4,58	
920.0004.16	JOINT FIBRE RACCORD STAND.15/21 1012095	U	49034.2	5,55	
920.0006.87	JOINT FIBRE RACCORD STAND.20/27 1014099	U	49053.2	9,16	
920.0011.92	JOINT FIBRE RACCORD STAND.26/34 -B100- 101602	U	80509.3	15,90	0,00
920.0009.44	JOINT FIBRE RACCORD STAND.33/42 -BT50- 101702	U	80510.1	12,59	0,00
920.0012.94	JOINT FIBRE RACCORD STAND.40/49 -BT50- 101802	U	80511.9	17,26	0,00
920.0010.40	JOINT FIBRE RACCORD STAND.50/60 -BT25- 101902	U	80512.7	13,86	0,00

WATTS
JOINT FIBRE

Pour raccord standard - Assortiment en coffret
de 760 joints



	DÉSIGNATION	UT	CODE	PPHT (€)	ECOPART (€)
920.0092.96	JOINT FIBRE RACCORD STANDARD-COFFRET- 109900	U	52506.3	123,95	0,00

WATTS
JOINT CAOUTCHOUC
SIRIUS® EPDM - EPDM



	DÉSIGNATION	UT	CODE	PPHT (€)	ECOPART (€)
920.0019.09	JOINT CAOUTCH.SIRIUS EPDM 12/17 -B100- 171102	U	24037.4	25,45	0,00
920.0020.83	JOINT CAOUTCH.SIRIUS EPDM 15/21 -B100- 171202	U	24040.8	27,77	0,00
920.0024.74	JOINT CAOUTCH.SIRIUS EPDM 20/27 -B100- 171402	U	24042.4	32,98	0,00
920.0028.00	JOINT CAOUTCH.SIRIUS EPDM 26/34 -B100- 171602	U	24043.2	37,34	0,00
920.0017.71	JOINT CAOUTCH.SIRIUS EPDM 33/42 -B50- 171702	U	77816.7	23,61	0,00
920.0021.98	JOINT CAOUTCH.SIRIUS EPDM 40/49 -B50- 171802	U	24045.7	29,30	0,00

Le PPHT comprend l'ecopart (€)

ROBINETTERIE BATIMENT

JOINT D'ETANCHEITE

WATTS
JOINT CNK BLEU

Pour eau, oxygène, hydrocarbures, milieux
alcalins non agressifs, installation solaire. -
Pour raccords

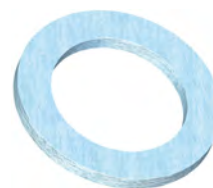

	DÉSIGNATION	UT	CODE	PPHT (€)	ECOPART (€)
920.0035.42	JOINT CNK BLEU 12/17 3/8" -BTE100- 122002	U	65939.1	47,22	0,00
920.0040.68	JOINT CNK BLEU 15/21 1/2" -BTE100- 122003	U	65912.8	54,24	0,00
920.0025.27	JOINT CNK BLEU 17/23 5/8" -BTE50- 122004	U	74688.3	33,69	0,00
920.0035.77	JOINT CNK BLEU 20/27 3/4" -BTE50- 122005	U	65916.9	47,69	0,00
920.0021.38	JOINT CNK BLEU 26/34 1" -BTE25- 122008	U	65926.8	28,51	0,00
920.0029.03	JOINT CNK BLEU 33/42 1 1/4" -BTE25- 122009	U	65930.0	38,71	0,00
920.0030.09	JOINT CNK BLEU 40/49 1 1/2" -BTE25- 122010	U	65931.8	40,12	0,00
920.0047.86	JOINT CNK BLEU 50/60 2" -BTE25- 122011	U	65937.5	63,81	0,00

WATTS
JOINT CNK BLEU

Pour eau, oxygène, hydrocarbures, milieux
alcalins non agressifs, installation solaire. -
Pour vanne à bride E29911

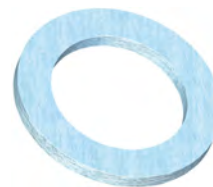

	DÉSIGNATION	UT	CODE	PPHT (€)	ECOPART (€)
920.0002.20	JOINT BRIDE CNK BLEU 33X63X2 DN20 23014702	U	51630.2	2,94	0,00
920.0002.53	JOINT BRIDE CNK BLEU 48X84X2 DN30 23014704	U	51730.0	3,37	0,00
920.0003.62	JOINT BRIDE CNK BLEU 54X94X2 DN40 23014705	U	51739.1	4,83	0,00
920.0004.33	JOINT BRIDE CNK BLEU 66X109X2 DN50 23014706	U	51749.0	5,77	0,00
920.0004.99	JOINT BRIDE CNK BLEU 82X129X2 DN65 23014707	U	51780.5	6,65	0,00
920.0006.40	JOINT BRIDE CNK BLEU 95X144X2 DN80 23014708	U	51787.0	8,53	0,00
920.0007.39	JOINT BRIDE CNK BLEU 120X164X2 DN100 23014709	U	51618.7	9,85	0,00
920.0008.21	JOINT BRIDE CNK BLEU 148X194X2 DN125 23014710	U	51623.7	10,95	0,00
920.0013.94	JOINT BRIDE CNK BLEU 176X220X2 DN150 23014711	U	51659.1	18,58	0,00
920.0017.93	JOINT BRIDE CNK BLEU 229X275X2 DN200 23014712	U	51723.5	23,91	0,00

WATTS
JOINT TEFLON
POLYTETRAFLUORETHYLENE

Tous fluides - Epaisseur 2 mm



	DÉSIGNATION	UT	CODE	PPHT (€)	ECOPART (€)
920.0033.22	JOINT TEFLON RAC.15/21 12X18.5X2-BT50- 238404	U	98248.8	44,29	0,00
920.0037.56	JOINT TEFLON RAC.20/27 16X24X2 238406	U	98250.4	50,08	0,00
920.0056.86	JOINT TEFLON RAC.26/34 22X30X2 238408	U	8371C.8	75,81	0,00

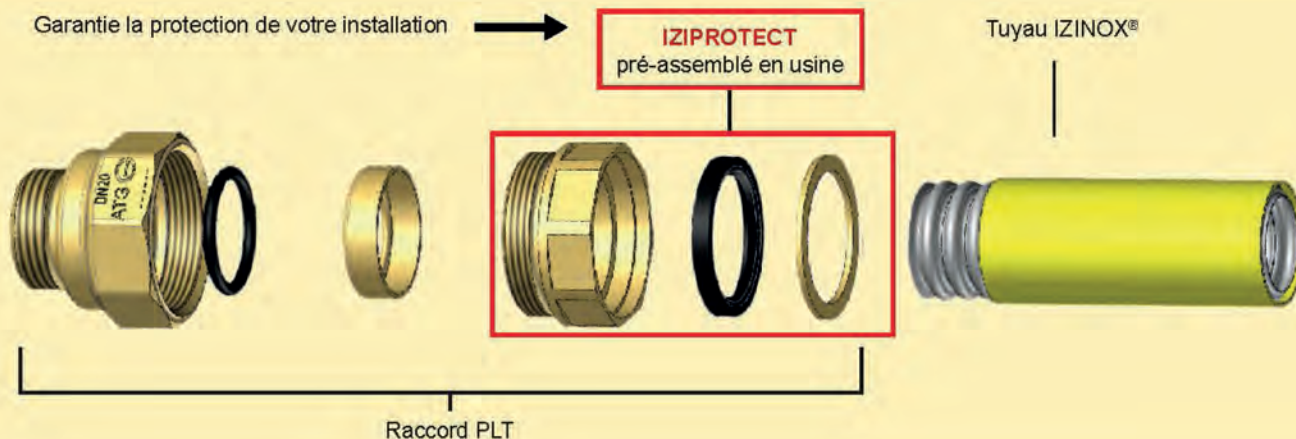

INSTALLEZ AVEC AISANCE, PROTÉGEZ AVEC CONFIANCE.

AVANTAGES DES RACCORDS IZINOX® AVEC LA SOLUTION IZIPROTECT

- **Protection fiable, sans ruban de protection** : Dites adieu aux contraintes du ruban traditionnel.
- **Efficacité contre tous les agents toxiques extérieurs**, assurant la sécurité de vos installations.
- **Raccords pré-assemblés pour une installation facilitée.**
- **IZIRING** : La bague d'encliquetage révolutionnaire.



Pour plus de renseignements
LIGNE TECHNIQUE DIRECTE

0 820 209 115 Service 0,09 € / min
+ prix appel

ou techniciengaz@gurtner.fr

www.gurtner-equipement-gaz.fr

SOMMAIRE

GAZ

TUBES GAZ POLYETHYLENE	140
SELECTION GAZ NATUREL	140
SELECTION GAZ PROPANE	142
SELECTION GAZ BUTANE	143
RACCORDS GAZ CUIVRE A SERTIR	144
RACCORDS TOUS GAZ	145
JOINT GAZ	146
ACCESSOIRES DE POSE POUR GAZ	147

GAZ

TUBES GAZ POLYETHYLENE



TUBE POLYETHYLENE HAUTE DENSITE BANDE JAUNE PE5-GAZ4



DÉSIGNATION	UT	CODE	PPHT (€)
271.0213.34 TUBE POLYETH.COIRONNE PE5 GAZ4 32X3.0 50M	U	33048.0	426,68



TUBE POLYETHYLENE HAUTE DENSITE BANDE JAUNE PE63-GAZ4



DÉSIGNATION	UT	CODE	PPHT (€)
271.0363.87 TUBE POLYETH.COIRONNE PE63 GAZ4 40X3.7 50M	U	34143.8	727,73

SELECTION GAZ NATUREL



BRANCHEMENT

Raccord 2 pièces à jonction sphéro conique - A braser sur cuivre



DÉSIGNATION	UT	CODE	PPHT (€)
440.0007.26 RACCORD ECROU 3/4 CU 18 -S.CTE- 18172.18K	U	3235V.8	7,26



BRANCHEMENT

Robinet coup de poing à jonction sphéro conique type F



DÉSIGNATION	UT	CODE	PPHT (€)
440.0339.39 ROBINET COUP DE POING MM3/4 24759	U	44173.3	452,52



CHAUFFAGE - INDUSTRIE - TERTIAIRE

Joint plat gaz synthétique NF - Sur carte



DÉSIGNATION	UT	CODE	PPHT (€)
440.0005.95 JOINT PLAT GAZ SYNTH.CAL.12 -PAR 10- 18223.K	U	75946.4	7,93
440.0006.74 JOINT PLAT GAZ SYNTH.CAL.15 -PAR 10- 18224.K	U	75948.0	8,98

GAZ

SELECTION GAZ NATUREL



CHAUFFAGE - INDUSTRIE - TERTIAIRE

Raccord 2 pièces à joint plat gaz - A braser sur tube cuivre



DÉSIGNATION	UT	CODE	PPHT (€)
440.0005.31 RACCORD ECR.G1/2 CU12 JPG 2PCS 18217.K	U	1757A.1	7,08
440.0005.39 RACCORD ECR.G1/2 CU14 JPG 2PCS CARTE 18218N.K	U	325Y0.2	7,19
440.0006.98 RACCORD ECR.G1/2 CU16 JPG 2PCS CARTE 18219N.K	U	325Y8.5	9,30
440.0010.19 RACCORD ECR.G1/2 CU18 JPG 2PCS CARTE 24026N.K	U	325YB.8	13,59
440.0009.09 RACCORD ECR.G3/4 CU16 JPG 2PCS 18228.K	U	20660.7	12,12
440.0009.50 RACCORD ECR.G3/4 CU18 JPG 2PCS 18229.K	U	1763A.3	12,66
440.0013.21 RACCORD ECR.G3/4 CU22 JPG 2PCS 18234.K	U	1766A.0	17,61
440.0018.44 RACCORD ECR.G1" CU22 JPG 2PCS 19136.K	U	0445C.7	24,59
440.0023.58 RACCORD ECR.G1" CU28 JPG 2PCS 19052.K	U	0442C.0	31,44



CHAUFFAGE - INDUSTRIE - TERTIAIRE

Raccord 3 pièces - A visser mâle conique 6,25% à braser sur tube cuivre



DÉSIGNATION	UT	CODE	PPHT (€)
440.0054.17 RACCORD JSC M.1"1/4 CU35 3PCS 21448	U	0284C.1	72,23
440.0143.01 RACCORD JSC M.2" CU54 3PCS 21450	U	0290C.3	190,68
440.0059.73 RACCORD JSC M.1" CU28 3PCS S.CARTE 21447K	U	3241V.0	59,73
440.0043.42 RACCORD JSC M.1/2 CU18 3PCS S.CARTE 21445.K	U	3490X.4	43,42
440.0045.10 RACCORD JSC M.3/4 CU22 3PCS S.CARTE 21446K	U	3241P.3	45,10



CHAUFFAGE - INDUSTRIE - TERTIAIRE

Robinet à joint plat gaz MOP 0,5 - Avec pattes de fixation



DÉSIGNATION	UT	CODE	PPHT (€)
440.0018.02 ROBINET ARRET DN12 M. G1/2 SUR CARTE 18230.K	U	0603C.5	24,03
440.0023.87 ROBINET ARRET DN15 M. G3/4 18245.K	U	0447C.5	31,83



COMPTAGE

Crosse de sortie de compteur - Contre-coudée



DÉSIGNATION	UT	CODE	PPHT (€)
440.0036.36 CROSSE SORTIE DE COMPT.20 CU22 110MM 18369.K	U	0429C.7	48,48
440.0081.33 CROSSE SORTIE DE COMPT.20 PE32 87MM 24203.K	U	8879A.9	108,44

GAZ

SELECTION GAZ NATUREL



COMPTAGE

Raccord pour compteur - 2 pièces -
A joint plat, compteur à braser sur
cuivre



	DÉSIGNATION	UT	CODE	PPHT (€)
440.0011.05	RACCORD ECR.6/20 CU22 +JT 2PCS S.CTE 24065.K	U	1671A.4	14,73
440.0007.94	RACCORD ECR. 6/20 CU22 +JT S.CTE 18235.K	U	0909C.6	10,59



COMPTAGE

Raccord pour compteur - Coudé 90° - A
joint plat compteur à braser sur cuivre



	DÉSIGNATION	UT	CODE	PPHT (€)
440.0016.16	COUDE 90 ECRU 20 AV.JT.PL.CU22 S.CTE 24053.K	U	0700G.8	21,54



COMPTAGE

Robinet de compteur type D - Tête à
manivelle



	DÉSIGNATION	UT	CODE	PPHT (€)
440.0039.01	ROBINET JPC MF CAL.20 MANIV. S.CTE 24008.K	U	0455C.4	52,01



COMPTAGE

Bouchon femelle - A joint plat
compteur



	DÉSIGNATION	UT	CODE	PPHT (€)
440.0019.92	ECROU BOUCHON 6/20 + JOINT 24077	U	8216B.9	19,92



COMPTAGE

Bouchon mâle - A joint plat compteur à tête
carrée



	DÉSIGNATION	UT	CODE	PPHT (€)
440.0004.79	BOUCHON JPC TETE CARRÉE S.CTE M.6/20 24145.K	U	2388G.3	6,39

GAZ

SELECTION GAZ NATUREL



COMPTAGE

Mamelon à joint plat compteur à souder sur
cuivre



	DÉSIGNATION	UT	CODE	PPHT (€)
440.0040.50	MAMELON A BRASER CU35 M.JPC32 +JT 24188.K	U	30963.3	40,50



HABITAT DOMESTIQUE

Bouchon femelle - Avec joint sur carte



	DÉSIGNATION	UT	CODE	PPHT (€)
440.0003.42	BOUCHON FEMELLE G1/2" NF LAIT.S.CARTE 21531.K	U	7320G.3	4,56



HABITAT DOMESTIQUE

R.O.A.I - Robinet à obturation automatique intégrée
- Pour cuisson domestique uniquement - Sur carte



	DÉSIGNATION	UT	CODE	PPHT (€)
440.0014.36	ROBINET ROAI G1/2 BRUT 23999.K	U	0458C.1	19,14
440.0016.12	ROBINET ROAI+BOUCHON G 1/2 24293.K	U	0457C.2	21,50



HABITAT DOMESTIQUE

Two-Inox - Flexibles inox démontable +
ensemble R.O.A.I - Entrée Mâle 1/2" -
Sortie écrou 1/2" avec bouchon



	DÉSIGNATION	UT	CODE	PPHT (€)
440.0075.76	ENSEMBLE TWO-INOX LONG.1M50 SS MARQ. 23900.03	U	0445J.3	101,01

RACCORD POUR TUBE
POLYETHYLENE

Raccord métal plastique à braser sur
cuivre



	DÉSIGNATION	UT	CODE	PPHT (€)
440.0020.86	RACCORD A BRASER PE20 CAL15 CU18 24050.K	U	0428C.8	27,81
440.0044.48	RACCORD A BRASER PE32 CAL25 CU22 24365.K	U	0446C.6	59,31
440.0032.80	RACCORD A BRASER PE32 CAL25 CU28 24051.K	U	0431C.3	43,74

GAZ

SELECTION GAZ NATUREL

RACCORD POUR TUBE POLYETHYLENE
 Raccord métal plastique à souder sur acier

	DÉSIGNATION	UT	CODE	PPHT (€)
440.0328.07	RACCORD A SOUDER PE63 CAL50 AC60.3 24069	U	02032.1	437,43
440.0077.55	RACCORD A SOUDER PE32 CAL15 AC33.7 24048.K	U	3095T.2	77,55

RACCORD 2 PIECES JOINT PLAT
 Raccord 2 pièces joint plat à braser sur tube cuivre

	DÉSIGNATION	UT	CODE	PPHT (€)
440.0041.88	RACCORD ECR.G1"1/4 CU28 JPG+JT-2PCES- 24029.K	U	3095R.6	41,88
440.0056.31	RACCORD ECR.1"1/2 CU35 JPG+JT -2PCES- 24085.K	U	3096Q.9	56,31

RACCORD POUR REGULATEUR
 Raccord d'entrée régulateur

	DÉSIGNATION	UT	CODE	PPHT (€)
440.0007.80	RACCORD JSC M 3/4 CU18 18174.18K	U	3094Q.9	7,80

ACCESSOIRES
 Clé de réarmement pour robinet

	DÉSIGNATION	UT	CODE	PPHT (€)
440.0030.65	CLE DE REARMEMENT COUP DE POING 24294.K	U	3096J.9	30,65

ACCESSOIRES POUR CONDUITES MONTANTES
 Manchette d'assemblage acier-cuivre

	DÉSIGNATION	UT	CODE	PPHT (€)
440.0042.84	MANCHETTE ACIER 33.7 CU 28 24122	U	03291.2	57,12
440.0048.04	MANCHETTE ACIER 42.4 CU 35 24123	U	03361.3	64,05
440.0069.21	MANCHETTE ACIER 60.3 CU 54 24124	U	03451.2	92,28

GAZ

SELECTION GAZ NATUREL

ACCESSOIRES POUR CONDUITES MONTANTES
 Joint plat compteur

	DÉSIGNATION	UT	CODE	PPHT (€)
440.0004.86	JOINT PLAT COMPTEUR CAL.20 -PAR 10- 19139.K	U	0433C.1	4,86

FLEXIBLE
 FF - 15x21 - Caoutchouc garantie 10 ans

	DÉSIGNATION	UT	CODE	PPHT (€)
440.0025.42	FLEXIBLE 10 ANS 1M GN NF -BLISTER- 19203	U	18932.4	33,90
440.0029.69	FLEXIBLE 10 ANS 1.5M GN NF -BLISTER- 19205	U	18934.0	39,59
440.0035.46	FLEXIBLE 10 ANS 2M GN NF -BLISTER- 19206	U	90144.7	47,28

FLEXIBLE
 FF - 15x21 - INOX sans date limite d'emploi (sous coque)

	DÉSIGNATION	UT	CODE	PPHT (€)
440.0038.18	FLEXIBLE INOX GN 1M ECR.G1/2 BLIST. 18513	U	01746.7	50,91
440.0041.44	FLEXIBLE INOX GN 1M50 ECR.G1/2-BLISTER- 18515	U	70172.2	55,26
440.0050.22	FLEXIBLE INOX GN 2M ECR.G1/2 BLIST. 18516	U	70174.8	66,96

SELECTION GAZ PROPANE

DETENDEUR A SECURITE
 DSP - Détendeur Sécurité Propane - 3 fonctions : robinet, détente et sécurité par coupure du débit

	DÉSIGNATION	UT	CODE	PPHT (€)
440.0069.80	DETENDEUR SECU.PROP.DSP 1.3KG/H37MB 14760.03K	U	52394.4	93,06
440.0069.80	DETENDEUR SECU.PROP.DSP 3KG/H 37MB 14770.03K	U	52397.7	93,06
440.0076.70	DETENDEUR SECU.PROP.DSP 5KG/H 37MB 14775.03K	U	19385.4	102,27
440.0128.97	DETENDEUR SECU.PROP.DSP 8KG/H 37MB 18050.03K	U	09966.3	171,96

DETENDEUR FIXE BASSE PRESSION
 DFP - Détendeur Fixe Propane

	DÉSIGNATION	UT	CODE	PPHT (€)
440.0059.58	DETENDEUR FIXE PROP. 4KG/H 37MBAR 14535.02K	U	75941.5	79,44

GAZ

SELECTION GAZ PROPANE



DETEUDEUR FIXE BASSE PRESSION
DFP - Détendeur Fixe Propane - A sécurité



	DÉSIGNATION	UT	CODE	PPHT (€)
440.0027.14	DETEUDEUR FIX.PROP.SEC.37MB 1,5KG/H 19221.02K	U	88234.0	36,18



DETEUDEUR INVERSEUR AUTOMATIQUE
DILP - Détendeur inverseur limiteur propane - Avec indicateur intégré - Sur carte



	DÉSIGNATION	UT	CODE	PPHT (€)
440.0258.42	DETEUDEUR INVERSEUR PROP.6KG/H D2ILP 25090.K	U	2214M.2	258,42



KIT PROPANE
Classe 1 - Raccordement cuisinière



	DÉSIGNATION	UT	CODE	PPHT (€)
440.0318.88	KIT PROPANE CLASSE 1 14660.NS	U	339HQ.2	425,18



FLEXIBLE FEMELLE - FEMELLE 15 X 21

Caoutchouc garantie 10 ans (sous coque)



	DÉSIGNATION	UT	CODE	PPHT (€)
440.0021.38	FLEXIBLE 10 ANS 1M BP NF -BLISTER- 20813	U	48722.3	28,50
440.0023.38	FLEXIBLE 10 ANS 1.5M BP NF -SACHET- 20815	U	48723.1	31,17
440.0026.50	FLEXIBLE 10 ANS 2M BP NF -BLISTER- 20816	U	63348.7	35,33



FLEXIBLE FEMELLE - FEMELLE 15 X 21
Inox sans date limite d'emploi (sous coque)



	DÉSIGNATION	UT	CODE	PPHT (€)
440.0038.18	FLEXIBLE INOX BP 1M 20X150 NF BLIST. 19193	U	70178.9	50,91
440.0041.44	FLEXIBLE INOX BP 1M50 20X150 NF -BLIST- 19195	U	70185.4	55,26
440.0050.22	FLEXIBLE INOX BP 2M 20X150 NF BLIST. 19196	U	70187.0	66,96

GAZ

SELECTION GAZ BUTANE



DETEUDEUR A SECURITE
DSB - Détendeur sécurité butane



	DÉSIGNATION	UT	CODE	PPHT (€)
440.0069.80	DETEUDEUR SECU.BUT.DSB 1.3KG/H 28MB 14795.03K	U	52427.2	93,06
440.0069.80	DETEUDEUR SECU.BUT.DSB 2.6KG/H 28MB 14800.03K	U	52431.4	93,06



DETEUDEUR BASSE PRESSION
AS3 M à sécurité



	DÉSIGNATION	UT	CODE	PPHT (€)
440.0016.58	DETEUDEUR AS3M+DECLenchement 19959.04K	U	78530.3	22,11



DETEUDEUR INVERSEUR AUTOMATIQUE
DIB - Détendeur inverseur butane - Avec indicateur intégré



	DÉSIGNATION	UT	CODE	PPHT (€)
440.0154.99	DETEUDEUR INVERS.DIB MURAL 2.6KG/H 12485.03K	U	52405.8	206,65



KIT DOMESTIQUE
Kit butane classe 1 - Raccordement cuisinière



	DÉSIGNATION	UT	CODE	PPHT (€)
440.0247.07	KIT BUTANE CLASSE 1 12745.N	U	71755.3	329,43



ROBINET HAUTE ET BASSE PRESSION BUTANE
Robinet haute et basse pression - RG8 avec sécurité - 20 bar



	DÉSIGNATION	UT	CODE	PPHT (€)
440.0035.35	ROBINET 1/4 TOUR LAITON RG8 14750.K	U	52443.9	47,13

GAZ

RACCORDS GAZ CUIVRE A SERTIR



RACCORD SERIE SUDO PRESS

Droit 2 pièces - SPG-RC-JPG



	DÉSIGNATION	UT	CODE	PPHT (€)
371.0025.15	RACCORD DROIT 2P. 16X1/2 -JPG 6675020	U	8413T.6	33,53



COUDE PROFIPRESS G SC-CONTUR

FF - 45° - 2626 - Joint HNBR



	DÉSIGNATION	UT	CODE	PPHT (€)
371.0010.14	COUDE 45 FF CUIVRE GAZ/FUEL 14 VIEGA 662356	U	42316.0	11,93
371.0010.58	COUDE 45 FF CUIVRE GAZ/FUEL 16 VIEGA 662363	U	15875.8	12,45
371.0005.98	COUDE 45 FF CUIVRE GAZ/FUEL 18 VIEGA 345617	U	8831B.4	7,03
371.0007.11	COUDE 45 FF CUIVRE GAZ/FUEL 22 VIEGA 345624	U	8834B.1	8,36
371.0019.51	COUDE 45 FF CUIVRE GAZ/FUEL 28 VIEGA 345631	U	0201G.2	22,95



COUDE PROFIPRESS G SC-CONTUR

MF - 45° - 2626.1 - Joint HNBR



	DÉSIGNATION	UT	CODE	PPHT (€)
371.0012.00	COUDE 45 FM CUIVRE GAZ/FUEL 14 VIEGA 662370	U	4216J.2	14,12
371.0005.54	COUDE 45 FM CUIVRE GAZ/FUEL 18 VIEGA 345686	U	68845.7	6,52
371.0006.33	COUDE 45 FM CUIVRE GAZ/FUEL 22 VIEGA 345693	U	8833B.2	7,45
371.0018.23	COUDE 45 FM CUIVRE GAZ/FUEL 28 VIEGA 345709	U	4216H.5	21,45



COUDE PROFIPRESS G SC-CONTUR

FF - 90° - 2616 - Joint HNBR



	DÉSIGNATION	UT	CODE	PPHT (€)
371.0005.47	COUDE 90 FF CUIVRE GAZ/FUEL 12 VIEGA 346850	U	8872B.4	6,43
371.0007.11	COUDE 90 FF CUIVRE GAZ/FUEL 14 VIEGA 662219	U	4215L.9	8,36
371.0004.89	COUDE 90 FF CUIVRE GAZ/FUEL 15 VIEGA 345464	U	8815B.4	5,75
371.0008.42	COUDE 90 FF CUIVRE GAZ/FUEL 16 VIEGA 662226	U	42165.1	9,91
371.0006.14	COUDE 90 FF CUIVRE GAZ/FUEL 18 VIEGA 345471	U	8818B.1	7,22
371.0007.62	COUDE 90 FF CUIVRE GAZ/FUEL 22 VIEGA 345488	U	8821B.6	8,96
371.0015.14	COUDE 90 FF CUIVRE GAZ/FUEL 28 VIEGA 345495	U	0201A.5	17,81
371.0028.25	COUDE 90 FF CUIVRE GAZ/FUEL 35 VIEGA 345501	U	0201D.9	33,24

GAZ

RACCORDS GAZ CUIVRE A SERTIR



COUDE PROFIPRESS G SC-CONTUR

MF - 90° - 2616.1 - Joint HNBR



	DÉSIGNATION	UT	CODE	PPHT (€)
371.0005.61	COUDE 90 MF CUIVRE GAZ/FUEL 12 VIEGA 346881	U	8824B.3	6,60
371.0008.21	COUDE 90 MF CUIVRE GAZ/FUEL 14 VIEGA 662233	U	4216E.1	9,66
371.0008.53	COUDE 90 MF CUIVRE GAZ/FUEL 16 VIEGA 662240	U	4216F.9	10,04
371.0005.68	COUDE 90 MF CUIVRE GAZ/FUEL 18 VIEGA 345549	U	8825B.2	6,68
371.0007.36	COUDE 90 MF CUIVRE GAZ/FUEL 22 VIEGA 345556	U	8823B.4	8,66
371.0016.01	COUDE 90 MF CUIVRE GAZ/FUEL 28 VIEGA 345563	U	0201E.6	18,83



TE PROFIPRESS G SC-CONTUR

FFF - Egal - 2618 - Joint HNBR



	DÉSIGNATION	UT	CODE	PPHT (€)
371.0014.37	TE EGAL CUIVRE GAZ/FUEL 14 VIEGA 662394	U	42176.8	16,91
371.0015.14	TE EGAL CUIVRE GAZ/FUEL 16 VIEGA 662400	U	4217C.5	17,81
371.0009.56	TE EGAL CUIVRE GAZ/FUEL 18 VIEGA 345945	U	8845B.8	11,25
371.0012.15	TE EGAL CUIVRE GAZ/FUEL 22 VIEGA 345952	U	8848B.5	14,29
371.0020.60	TE EGAL CUIVRE GAZ/FUEL 28 VIEGA 345969	U	0205I.4	24,24



TE PROFIPRESS G SC-CONTUR

FFF - Réduit - 2618 - Joint HNBR



	DÉSIGNATION	UT	CODE	PPHT (€)
371.0021.34	TE RED. CUIVRE GAZ/FUEL 22X14X22 VIEGA 677664	U	15865.9	28,45
371.0010.45	TE RED. CUIVRE GAZ/FUEL 22X15X22 VIEGA 346027	U	0204K.2	12,29
371.0012.15	TE RED. CUIVRE GAZ/FUEL 22X18X22 VIEGA 346034	U	0204L.0	14,29
371.0023.88	TE RED. CUIVRE GAZ/FUEL 28X22X28 VIEGA 346065	U	0205E.2	28,09



MANCHON PROFIPRESS G SC-CONTUR

FF - 2615



	DÉSIGNATION	UT	CODE	PPHT (€)
371.0005.61	MANCHON FF CUIVRE GAZ/FUEL 12 VIEGA 347055	U	8861B.7	6,60
371.0005.92	MANCHON FF CUIVRE GAZ/FUEL 14 VIEGA 662417	U	4217I.2	6,96
371.0004.89	MANCHON FF CUIVRE GAZ/FUEL 15 VIEGA 346485	U	8864B.4	5,75
371.0006.44	MANCHON FF CUIVRE GAZ/FUEL 16 VIEGA 662424	U	4217J.1	7,58
371.0006.07	MANCHON FF CUIVRE GAZ/FUEL 18 VIEGA 346492	U	8866B.2	7,14
371.0007.19	MANCHON FF CUIVRE GAZ/FUEL 22 VIEGA 346508	U	8865B.3	8,46
371.0012.66	MANCHON FF CUIVRE GAZ FUEL 28 VIEGA 346515	U	02043.8	14,90
371.0015.40	MANCHON FF CUIVRE GAZ FUEL 35 VIEGA 346522	U	02044.6	18,12

GAZ

RACCORDS GAZ CUIVRE A SERTIR

viega

REDUCTION PROFIPRESS G SC-CONTUR
MF - 2615.1



	DÉSIGNATION	UT	CODE	PPHT (€)
371.0004.65	REDUCTION MF CUIVRE GAZ 15X12 VIEGA 347062	U	0205D.5	5,47
371.0009.48	REDUCTION MF CUIVRE GAZ 16X14 VIEGA 662431	U	4218H.3	11,15
371.0004.50	REDUCTION MF CUIVRE GAZ 18X15 VIEGA 346553	U	0205J.3	5,30
371.0009.93	REDUCTION MF CUIVRE GAZ 18X16 VIEGA 662448	U	4218I.1	11,68
371.0004.69	REDUCTION MF CUIVRE GAZ 22X15 VIEGA 346560	U	0205K.1	5,52
371.0007.11	REDUCTION MF CUIVRE GAZ 22X16 VIEGA 662455	U	4218J.0	8,36
371.0004.89	REDUCTION MF CUIVRE GAZ 22X18 VIEGA 346577	U	02063.6	5,75
371.0011.32	REDUCTION MF CUIVRE GAZ 28X15 VIEGA 346584	U	02064.4	13,32
371.0011.63	REDUCTION MF CUIVRE GAZ 28X18 VIEGA 346591	U	0206D.4	13,68
371.0012.00	REDUCTION MF CUIVRE GAZ 28X22 VIEGA 346607	U	0206E.1	14,12

viega

BOUCHON PROFIPRESS G SC-CONTUR
Femelle - 2656



	DÉSIGNATION	UT	CODE	PPHT (€)
371.0011.70	BOUCHON F CUIVRE GAZ/FUEL 12 VIEGA 438722	U	0207L.7	13,77
371.0009.25	BOUCHON F CUIVRE GAZ/FUEL 15 VIEGA 352790	U	02087.5	10,88
371.0011.70	BOUCHON F CUIVRE GAZ/FUEL 18 VIEGA 352806	U	0208G.5	13,77
371.0014.82	BOUCHON F CUIVRE GAZ/FUEL 22 VIEGA 352813	U	0209C.3	17,44

viega

RACCORD PROFIPRESS G SC-CONTUR
Raccord 2 pièces - 2664JPG - Bronze



	DÉSIGNATION	UT	CODE	PPHT (€)
371.0018.09	RACCORD COMPT.2P.BRZE GAZ 14X1/2 VIEGA 662288	U	4219D.1	21,28
371.0018.39	RACCORD COMPT.2P.BRZE GAZ 15X1/2 VIEGA 653903	U	4219E.8	21,44
371.0018.90	RACCORD COMPT.2P.BRZE GAZ 16X3/4 VIEGA 662011	U	4219F.6	22,24
371.0020.03	RACCORD COMPT.2P.BRZE GAZ 18X3/4 VIEGA 653927	U	4219G.4	23,56
371.0022.70	RACCORD COMPT.2P.BRZE GAZ 22X3/4 VIEGA 662028	U	4219H.2	26,71
371.0027.73	RACCORD COMPT.2P.BRZE GAZ 22X1 VIEGA 653934	U	4219I.0	32,62
371.0043.47	RACCORD COMPT.2P.BRZE GAZ28X11/4 VIEGA 653941	U	4219J.9	51,14
371.0063.15	RACCORD COMPT.2P.BRZE GAZ35X11/2 VIEGA 663155	U	4219K.7	74,29

viega

RACCORD PROFIPRESS G SC-CONTUR
Raccord compteur 2 pièces - 2664JPC - Bronze



	DÉSIGNATION	UT	CODE	PPHT (€)
371.0020.03	RACCORD COMPT.2P.BRZE GAZ18X6/20 VIEGA 654061	U	4220D.8	23,56

GAZ

RACCORDS GAZ CUIVRE A SERTIR

viega

RACCORD PROFIPRESS G SC-CONTUR
Raccord compteur 2 pièces - 2664JPC - Bronze - suite



	DÉSIGNATION	UT	CODE	PPHT (€)
371.0027.73	RACCORD COMPT.2P.BRZE GAZ22X6/20 VIEGA 654078	U	4220E.5	32,62

Conex | Bänninger

BOUCHON >B< PRESS GAS
Femelle - PG5301



	DÉSIGNATION	UT	CODE	PPHT (€)
025.0020.05	BOUCHON SERT.GAZ CU FEM.14 PG5301 0140000	U	181FN.4	20,05
025.0022.02	BOUCHON SERT.GAZ CU FEM.16 PG5301 0160000	U	181FR.8	22,02

RACCORDS TOUS GAZ

GURTNER
le gaz, notre métier

RACCORD A JOINT PLAT
Raccord coudé - 90° à joint plat gaz



	DÉSIGNATION	UT	CODE	PPHT (€)
440.0010.66	COUDE 90 MF G1/2 JPG CAL12 CARTE 24217N.K	U	325YC.6	14,22

GURTNER
le gaz, notre métier

RACCORD A JOINT PLAT
Raccord coudé - 180° à joint plat gaz à braser sur cuivre



	DÉSIGNATION	UT	CODE	PPHT (€)
440.0016.22	RACCORD COUDE 180 JOINT PLAT GAZ CU14 24225.K	U	0432C.2	21,63

GURTNER
le gaz, notre métier

RACCORD A JOINT PLAT
Raccord coudé - Compteur à braser sur cuivre



	DÉSIGNATION	UT	CODE	PPHT (€)
440.0015.26	RACCORD COUDE 90 COMPT.G4 CU22 18364.K	U	0439C.5	20,34

GAZ

RACCORDS TOUS GAZ



RACCORD A JOINT PLAT
Réduction femelle/mâle



	DÉSIGNATION	UT	CODE	PPHT (€)
440.0007.43	REDUCTION F.G1/2" M.M20X150 A.JPG CT 20709N.K	U	3426F.6	7,43



RACCORD GAZ NATUREL - GAZ PROPANE

Mamelon à joint plat compteur - A braser sur cuivre - Avec joint



	DÉSIGNATION	UT	CODE	PPHT (€)
440.0014.01	MAMELON A BRASER CU22 M.JPC20 S.CTE 19143.K	U	2930M.5	14,01



RACCORD POUR BOUTEILLE
Té de couplage



	DÉSIGNATION	UT	CODE	PPHT (€)
440.0032.58	TE COUPLAGE BOUTEILLE M.20X150 S.CTE 08864N.K	U	300ZS.8	43,44



ACCESSOIRES BUTANE - PROPANE
Bouchon



	DÉSIGNATION	UT	CODE	PPHT (€)
440.0006.70	BOUCHON ECROU 20X150 +JOINT 19153.K	U	75006.7	8,94



ACCESSOIRES BUTANE - PROPANE
Lyre - Durée limite d'utilisation : 5 ans



	DÉSIGNATION	UT	CODE	PPHT (€)
440.0022.38	LYRE CAOUTCHOUC 0M35 ECR.BOUT. 08860.K	U	21976.6	29,84
440.0032.56	LYRE CAOUTCHOUC 0M70 ECR.BOUT. 08860.01K	U	52462.9	43,41



ACCESSOIRES BUTANE - PROPANE
Mamelon 20 x 150



	DÉSIGNATION	UT	CODE	PPHT (€)
440.0009.52	MAMELON A BRASER CU14 M.20X150 08923.14K	U	50028.0	12,70

GAZ

RACCORDS TOUS GAZ



ACCESSOIRES BUTANE - PROPANE
Raccord 2 pièces 20 x 150



	DÉSIGNATION	UT	CODE	PPHT (€)
440.0007.12	RACCORD COMPLET A SOUDER CU10 08769.10K	U	28666.6	9,49
440.0004.48	RACCORD COMPLET A SOUDER CU12 08769.12K	U	52464.5	5,97
000.0004.57	RACCORD COMPLET A SOUDER CU14 08769N.14K	U	334W8.9	6,09



ACCESSOIRES BUTANE - PROPANE
Raccord double Mâle



	DÉSIGNATION	UT	CODE	PPHT (€)
440.0016.26	RACCORD DBLE MALE 20X150 09816.K	U	07034.2	16,26
440.0010.77	RACCORD DBLE MALE 20X150/BOUT. 09526.K	U	45043.7	15,38
440.0011.62	RACCORD DBLE MALE 20X150-G1/2 23991.K	U	23881.6	15,50

JOINT GAZ



JOINT POUR ECRU
Propane



	DÉSIGNATION	UT	CODE	PPHT (€)
440.0003.42	JOINT ECRU 20X150 BRUN -PAR 10-S.CTE 08663.K	U	46615.1	4,56
440.0003.42	JOINT ECRU BOUT.NOIR -PAR 10-S.CTE 07119.K	U	21972.5	4,56



JOINT
Joint en HNBR



	DÉSIGNATION	UT	CODE	PPHT (€)
000.0002.21	JOINT HNBR 14.1X2.5 VIEGA 663575	U	4220J.6	2,60
000.0002.33	JOINT HNBR 16.0X2.5 VIEGA 663582	U	4220K.4	2,74
000.0002.45	JOINT HNBR 18.2X2.5 VIEGA 348595	U	68558.6	2,88
000.0002.57	JOINT HNBR 22.2X3.10 VIEGA 348601	U	68559.4	3,02



JOINT CAOUTCHOUC
SIRGAZ® - Joint plat gaz (JPG)



	DÉSIGNATION	UT	CODE	PPHT (€)	ECOPART (€)
920.0013.48	JOINT SIRGAZ JPG DN12 12,4X18,2X2 122020 9	U	2854Y.4	17,97	0,00
920.0022.88	JOINT SIRGAZ JPG DN15 18,4X23,8X2 122021 6	U	2855M.6	30,51	0,00

Le PPHT comprend l'ecopart (€)

GAZ

JOINT GAZ



JOINT CAOUTCHOUC

SIRGAZ® - Joint plat gaz (JPG)

- suite



.	DÉSIGNATION	UT	CODE	PPHT (€)	ECOPART (€)
920.0026.25	JOINT SIRGAZ JPG DN20 22,4X30X2 122022 3	U	2855N.4	35,00	0,00
920.0035.60	JOINT SIRGAZ JPG DN25 30,4X38,5X2 122023 0	U	2855P.2	47,46	0,00
920.0036.91	JOINT SIRGAZ JPG DN32 38,5X44,5X2 122024 7	U	2855Q.0	49,21	0,00

ACCESSOIRES DE POSE POUR GAZ



GRILLAGE AVERTISSEUR JAUNE

Jaune, en rouleau de 100 m



.	DÉSIGNATION	UT	CODE	PPHT (€)
920.0032.80	GRILLAGE AVERTISSEUR NORMALISE JAUNE 100X30	U	57743.7	43,74

Pour plus d'infos,
consultez
le CAHIER TECHNIQUE
page 14

100% EXPO



Faites de nos salles Expo vos outils de vente

- Des espaces dédiés à la Salle de Bains et au Carrelage
- Les dernières tendances
- Des conseillers pour accompagner vos clients dans leur projet

Le PPHT comprend l'ecopart (€)

Les tarifs et disponibilités de nos produits peuvent évoluer sans préavis

RICHARDSON

| 147 |

atlantic

CALYPSO CONNECTÉ SUR SOCLE

Le chauffe-eau thermodynamique performant,
l'intelligence en plus.



- Technologie thermodynamique et ACI Hybride
- Jusqu'à 75% d'économies¹
- Connecté WiFi
- Raccordement possible aux panneaux photovoltaïques
- Éligible aux CEE et à MaPrimeRenov'

JUSQU'À
75%
D'ÉCONOMIES



A+
F

(1) Pourcentage maximum d'économies résultant d'une comparaison effectuée entre l'efficacité énergétique d'un chauffe-eau électrique Zénéo 200L sur socle et d'un chauffe-eau thermodynamique Calypso Connecté 200L sur socle sur la base des informations ErP dans les conditions climatiques plus chaudes. Ce pourcentage maximum d'économies est de 71% dans les conditions climatiques moyennes. Economie calculée sur la consommation moyenne d'eau d'un foyer de 5 personnes selon le «Guide technique – les besoins d'eau chaude sanitaire en habitat individuel et collectif» de 2016 édité par l'ADEME et sur la base du tarif heure creuse du fournisseur historique d'électricité (0,1828 €/kWh)

• MARQUE FRANÇAISE • RECOMMANDÉE PAR LES PROFESSIONNELS • SOLUTIONS CONNECTÉES

Eau chaude sanitaire

SOMMAIRE

PRODUCTION D'EAU CHAUDE SANITAIRE

CHOISISSEZ VOTRE CHAUFFE-EAU ÉLECTRIQUE.....	150
CHAUFFE-EAU THERMODYNAMIQUE	151
ACCESSOIRES CHAUFFE-EAU THERMODYNAMIQUE	151
CHAUFFE-EAU ELECTRIQUE	152
CHAUFFE-EAU - CHAUFFE BAIN GAZ	154
GROUPE DE SECURITE ET ACCESSOIRES	155

CHOISISSEZ VOTRE CHAUFFE-EAU ÉLECTRIQUE

atlantic

Gamme	Référence modèle	Position	Litrage (L)	Désignation	Code RICHARDSON	Classe énergétique	Puissance nominale (kw)	Temps de chauffe	Poids (kg)	H Hauteur (mm)	D Diamètre (mm)	E Entraxe (mm)	A Hauteur sup. (mm)	B Hauteur inf. (mm)		
STÉATITE ACI	154116	VERT.	150	CHAUF.EAU AQUEO ACI HYB.VERT.MUR. 150L 154116	337L6.1	C	2,2	4h27	35	1155	513	800	105	1050		
	154117	VERT.	200	CHAUF.EAU AQUEO ACI HYB.VERT.MUR. 200L 154117	337L9.5	C	2,2	6h05	45	1475	513	800	425	1050		
	154431	SOCLE	300	CHAUF.EAU AQUEO ACI HYB.VERT.SOC. 300L 154431	337LA.2	C	3	6h15	60	1765	575	-	-	280		
	153108	VERT.	75	CHAUF.EAU ZENEO ACI HYB.VM 75L 153108	300LS.6	C	1,2	4H08	23	705	513	-	-	135	570	
	153109	VERT.	100	CHAUF.EAU ZENEO ACI HYB.VM MONO 100L C 153109	299AM.1	C	1,28	5H27	27	835	513	-	-	85	750	
	156211	VERT.	100	CHAUF.EAU ZENEO ACI HYB.STVM CP 100LM 156211	338PC.8	C	1,2	5h29	32	740	567	-	-	165	590	
	153111	VERT.	150	CHAUF.EAU ZENEO ACI HYB.VM MONO 150L C 153111	299AN.9	C	1,65	5h14	35	1155	513	800	105	1050		
	156212	VERT.	150	CHAUF.EAU ZENEO ACI HYB.STVM CP 150LM 156212	338PD.6	C	1,8	5h09	41	990	567	500	235	750		
	153112	VERT.	200	CHAUF.EAU ZENEO ACI HYB.VM MONO 200L C 153112	299AP.7	C	1,94	5h44	45	1475	513	800	425	1050		
	156213	VERT.	200	CHAUF.EAU ZENEO ACI HYB.STVM CP 200LM 156213	338PF.1	C	2,2	5h53	51	1245	567	800	190	590		
	155411	HORIZ.	100	CHAUF.EAU ZENEO ACI HYB.HM DESS.100L 155411	349KZ.0	C	1,8	2h59	32	830	520	500	135	275		
	155412	HORIZ.	150	CHAUF.EAU ZENEO ACI HYB.HM DESS.150L 155412	349KA.8	C	1,8	4h20	39	1140	520	800	150	575		
	155413	HORIZ.	200	CHAUF.EAU ZENEO ACI HYB.HM DESS.200L 155413	349MQ.6	C	2,2	5h08	44	1460	520	800	470	575		
	154316	SOCLE	150	CHAUF.EAU ZENEO ACI HYB.VS 150L 154316	318VU.9	C	1,8	4h19	42	1015	575	-	-	280		
	154317	SOCLE	200	CHAUF.EAU ZENEO ACI HYB.VS 200L 154317	318VW.5	C	2,2	5h14	47	1270	575	-	-	280		
	154318	SOCLE	250	CHAUF.EAU ZENEO ACI HYB.VS 250L 154318	313HK.7	C	3	4h58	53	1510	575	-	-	280		
	154319	SOCLE	300	CHAUF.EAU ZENEO ACI HYB.VS 300L 154319	318VY.1	C	3	6h18	60	1765	575	-	-	280		
	STÉATITE	053005	VERT.	50	CHAUF.EAU CHAUFFEO+ .STVM 50L MO 053005	60008.0	C	1,2	2h46	23	575	505	-	-	370	
		053014	VERT.	75	CHAUF.EAU CHAUFFEO+ .STVM 75L MO 053014	300M1.9	C	1,2	4H09	23	705	513	-	-	135	570
		053015	VERT.	100	CHAUF.EAU CHAUFFEO+ .STVM 100L 053015	299AC.1	C	1,2	5H12	27	835	513	-	-	85	750
053016		VERT.	150	CHAUF.EAU CHAUFFEO+ .STVM 150L 053016	299AD.9	C	1,8	5H12	35	1155	513	800	105	1050		
053017		VERT.	200	CHAUF.EAU CHAUFFEO+ .STVM 200L 053017	299AE.6	C	2,2	6H11	44	1475	513	800	425	1050		
053021		SOCLE	200	CHAUF.EAU CHAUFFEO+ .STVS 200L MO 053021	318VZ.0	C	2,2	5h22	47	1270	575	-	-	280		
053022		SOCLE	250	CHAUF.EAU CHAUFFEO+ .STVS 250L MO 053022	318W1.7	C	3	4h45	53	1510	575	-	-	280		
053023		SOCLE	300	CHAUF.EAU CHAUFFEO+ .STVS 300L MO 053023	318W3.3	C	3	6h08	60	1765	575	-	-	280		
157205		HV	40	CHAUF.EAU LINEO CONN.ST.MULTI. BLC 40L 157205	299AF.4	B	2,25	1H46	24,5	765	-	500	155	610		
157207		HV	65	CHAUF.EAU LINEO CONN.ST.MULTI. BLC 65L 157207	299AG.2	B	2,25	2H52	32,5	1090	-	700	115	975		
STÉATITE PLAT	157209	HV	80	CHAUF.EAU LINEO CONN.ST.MULTI. BLC 80LMO157209	299AH.0	B	2,25	3H32	37,5	1300	-	800	115	1185		
	157216	HV	100	CHAUF.EAU LINEO CONN.ST.MULTI. BLC100LMO 157216	A015M.5	B	2,25	4h25	40	1241	-	800	117,5	1122		
	157213	VM	100	CHAUF.EAU LINEO CONN.ST.CAR VM BLC100 157213	299AJ.7	B	2,4	2h28	32	885	-	-	100	760		
	157214	VM	120	CHAUF.EAU LINEO CONN.ST.CAR VM BLC120L 157214	299AK.5	B	2,4	3h08	36	1015	-	-	100	895		
	157215	VM	150	CHAUF.EAU LINEO CONN.ST.CAR VM BLC150L 157215	299AL.3	B	2,4	3H40	42	1205	-	800	80	1105		
	321105	VERT.	50	CHAUF.EAU CHAUFFEO .BLVM 50L MO 321105	06077.2	C	1,2	2h26	17	575	505	-	-	370		
BLINDÉ	021113	VERT.	75	CHAUF.EAU CHAUFFEO .BLVM 75L 021113	300LU.1	C	1,2	4H12	22	705	513	-	-	135	570	
	021114	VERT.	100	CHAUF.EAU CHAUFFEO .BLVM 100L 021114	300LV.9	C	1,2	5H13	26	835	513	-	-	85	750	
	021225	VM	100	CHAUF.EAU CHAUFFEO .BLVM CP 100L 021225	338P8.7	C	1,2	5h28	29	740	570	-	-	165	570	
	021226	VM	150	CHAUF.EAU CHAUFFEO .BLVM CP 150L 021226	338P9.5	C	1,6	6h00	38	990	570	500	235	750		
	021116	VERT.	150	CHAUF.EAU CHAUFFEO .BLVM 150L 021116	300LX.5	C	1,6	5H50	34	1155	513	800	105	1050		
	021117	VERT.	200	CHAUF.EAU CHAUFFEO .BLVM 200L 021117	300MO.1	C	2,2	5H42	43	1475	513	800	425	1050		
	021 227	VM	200	CHAUF.EAU CHAUFFEO .BLVM CP 200L 021227	338PA.2	C	2,2	5h55	44	1245	570	800	190	1050		
	023152	HORIZ.	75	CHAUF.EAU CHAUF.BL.HM RACC DESS 75L MO 023152	353SN.2	C	1,6	2h59	28	700	520	370	120	-		
	025108	HORIZ.	75	CHAUF.EAU CHAUF. BL.HM RACC COTE 75L MO 025108	354WU.3	C	2	2h27	22	705	513	ceintures réglables	-	-		
	023172	HORIZ.	100	CHAUF.EAU CHAUF.BL.HM RAC DESS.100L MO 023172	349L5.8	C	1,6	3h36	32	830	520	500	150	-		
	025109	HORIZ.	100	CHAUF.EAU CHAUF.BL.HM RAC COTE 100L MO 025109	349L9.0	C	2	3h15	29	740	567	ceintures réglables	-	-		
	023178	HORIZ.	150	CHAUF.EAU CHAUF.BL.HM RAC DESS.150L MO 023178	348X8.8	C	2,2	4h03	39	1140	520	800	150	-		
	025122	HORIZ.	150	CHAUF.EAU CHAUF.BL.HM RAC COTE 150L MO 025122	348X8.1	C	2	4h55	38	990	567	ceintures réglables	-	-		
	025118	HORIZ.	200	CHAUF.EAU CHAUF.BL.HM RAC COTE 200L MO 025118	349L6.6	C	2	6h14	44	1245	567	ceintures réglables	-	-		
	023193	HORIZ.	200	CHAUF.EAU CHAUF.BL.HM RAC DESS.200L MO 023193	349L3.3	C	2,2	5h06	48	1460	520	800	470	575		
	022121	SOCLE	200	CHAUF.EAU CHAUFFEO .BLVS 200L Z200M MO 022121	325Z9.2	C	2,2	5h06	47	1270	575	-	-	280		
	022122	SOCLE	300	CHAUF.EAU CHAUFFEO .BLVS 300L 3000M MO 022122	325Z8.7	C	3	5h53	60	1765	575	-	-	280		
	022123	SOCLE	300	CHAUF.EAU CHAUFFEO .BLVS 300L 3300TC 022123	325ZC.5	C	3	5h51	60	1765	575	-	-	280		
022750	SOCLE	500	CHAUF.EAU CHAUFFEO .BLVS 500L 5000TC 022750	8556X.4	C	5	5h53	154	1838	750	-	-	310			
PETITES CAPACITÉS	325116	VERT.	15	CHAUF.EAU BL.PC ETR SUR EV.015L MO 325116	93845.6	B	2	0h29	7,5	496	287	-	169	237		
	325216	VERT.	15	CHAUF.EAU BL.PC COMP SUR EV. 15L MO 325216	70523.6	B	1,6	0h37	7,5	400	338	-	163	236		
	326216	VERT.	15	CHAUF.EAU BL.PC COMPS EV.15L MO 326216	70526.9	B	2	0h23	7,5	400	338	-	235	164		
	321104	VERT.	30	CHAUF.EAU BL.PC ETR SUR EV. 30L MO 321104	70968.3	C	2	0h52	11	623	338	-	160	463		
	327106	VERT.	50	CHAUF.EAU BL.PC ETR SUR EV 50L MO 327106	72326.2	C	2	1h36	15	920	338	-	168	750		
PETITES CAPACITÉS CARRÉES	821502	CARRE	15	CHAUF.EAU ODEO 15L SOUS EVIER COMPACT 821502	349LE.8	B	2	0h24	8	378	360	-	-	-		
	821501	CARRE	15	CHAUF.EAU ODEO 15L SUR EVIER COMPACT 821501	349LB.5	A	2	0h24	7,9	387	360	-	-	-		
	831232	CARRE	30	CHAUF.EAU ODEO 30L 2000M SUR EVIER 831232	348XD.7	C	2	0h56	11,8	467	440	-	-	-		
	321114	HORIZ.	30	CHAUF.EAU ODEO HM SUR EVIER 30L 321114	355KA.5	C	2,5	0h38	14,6	335	810	-	-	-		
CHAUFFE-EAU REMPLACEMENT	341074	VERT.	30	CHAUF.EAU EASY SWITCH EL 341074	263ZH.7			0h35	20	87	39	-	-	-		

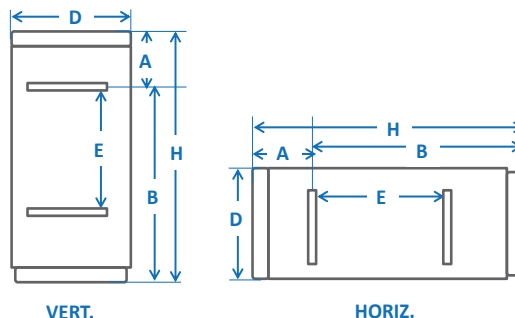

PRODUCTION D'EAU CHAUDE SANITAIRE

CHAUFFE-EAU THERMODYNAMIQUE

atlantic



AQUACOSY AV

Chauffe-eau thermodynamique sur VMC - Logement individuel - Easykit inclus



	DÉSIGNATION	UT	CODE	PPHT (€)	ECOPART (€)
782.3588.99	CHAUF.EAU THERMO.AQUACOSY SV 100L 350103	U	1428T.4	3602,57	13,58
782.4127.00	CHAUF.EAU THERMO.AQUACOSY SV 200L 350104	U	1429M.5	4140,58	13,58

atlantic



CALYPSO SPLIT

Chauffe-eau thermodynamique haute performance - Vertical sur socle



	DÉSIGNATION	UT	CODE	PPHT (€)	ECOPART (€)
792.1561.24	CHAUF.EAU THERM.CALYPSO SP.R32 VS 270L 232520	U	389NU.2	2066,91	11,92

atlantic



CALYPSO SPLIT

Chauffe-eau thermodynamique haute performance - Vertical mural



	DÉSIGNATION	UT	CODE	PPHT (€)	ECOPART (€)
792.1236.00	CHAUF.EAU THERM.CALYPSO SP.R32 VM 150L 232518	U	389NY.4	1659,92	11,92
792.1299.75	CHAUF.EAU THERM.CALYPSO SP.R32 VM 200L 232519	U	389NZ.3	1744,92	11,92

atlantic



CALYPSO SPLIT

Unité extérieure



	DÉSIGNATION	UT	CODE	PPHT (€)	ECOPART (€)
782.0549.00	UNITE EXT.P.CALYPSO SPLIT R32 232521	U	389PO.7	738,67	6,67

atlantic



CALYPSO CONNECTE

Chauffe-eau thermodynamique sur socle



	DÉSIGNATION	UT	CODE	PPHT (€)	ECOPART (€)
792.1940.25	CHAUF.EAU THERM.CALYPSO CO.VS 250L 286041	U	170YL.8	2600,58	13,58

Le PPHT comprend l'ecopart (€)

PRODUCTION D'EAU CHAUDE SANITAIRE

ACCESSOIRES CHAUFFE-EAU THERMODYNAMIQUE

atlantic



GAINE PEHD



	DÉSIGNATION	UT	CODE	PPHT (€)	ECOPART (€)
782.0037.50	GAINE PEHD 1.40M D160 ODYSSEE 2 423014	U	9489J.1	50,06	0,06

atlantic

TREPIED RACCOURCI

Plafond bas



	DÉSIGNATION	UT	CODE	PPHT (€)	ECOPART (€)
782.0042.80	TREPIED RACCOURCI PLAFOND BAS AQUACOSY 350007	U	311UX.9	53,64	0,14

100% Exclusivités

TEKNIK

par **.GITRAL.**



VASE D'EXPANSION

Chauffage en 12, 18, 25 et 35L



Raccord rapide

Pensez aux accessoires



Sanitaire en 8L et 12L



Uniquement chez **RICHARDSON**

PRODUCTION D'EAU CHAUDE SANITAIRE

CHAUFFE-EAU ELECTRIQUE

atlantic

CHAUFFEO PLUS - RESISTANCE STEATITE

Chauffe-eau vertical mural



	DÉSIGNATION	UT	CODE	PPHT (€)	ECOPART (€)
782.0579.00	CHAUF.EAU CHAUFFEO+ .ST.VM 50L MO 053005	U	60008.0	590,92	11,92
782.0472.00	CHAUF.EAU CHAUFFEO+ .ST.VM 75L MO 053014	U	300M1.9	601,92	11,92
781.0468.80	CHAUF.EAU CHAUFFEO+ .ST.VM 100L 053015	U	299AC.1	597,92	11,92
781.0539.20	CHAUF.EAU CHAUFFEO+ .ST.VM 150L 053016	U	299AD.9	685,92	11,92
781.0617.60	CHAUF.EAU CHAUFFEO+ .ST.VM 200L 053017	U	299AE.6	783,92	11,92

atlantic

CHAUFFEO PLUS - RESISTANCE STEATITE

Chauffe-eau vertical sur socle



	DÉSIGNATION	UT	CODE	PPHT (€)	ECOPART (€)
782.0856.50	CHAUF.EAU CHAUFFEO+ .ST.VS 200L MO 053021	U	318VZ.0	1153,92	11,92
782.0849.00	CHAUF.EAU CHAUFFEO+ .ST.VS 250L MO 053022	U	318W1.7	1143,92	11,92
781.0966.00	CHAUF.EAU CHAUFFEO+ .ST.VS 300L MO 053023	U	318W3.3	1299,92	11,92

atlantic

CHAUFFEO - RESISTANCE BLINDEE

Chauffe-eau vertical mural - Standard Ø 505, 510 et 530 mm



	DÉSIGNATION	UT	CODE	PPHT (€)	ECOPART (€)
781.0351.40	CHAUF.EAU CHAUFFEO .BL.VM 50L MO 321105	U	06077.2	513,92	11,92
781.0377.60	CHAUF.EAU CHAUFFEO .BL.VM 100L 021114	U	300LV.9	483,92	11,92
781.0437.60	CHAUF.EAU CHAUFFEO .BL.VM 150L 021116	U	300LX.5	558,92	11,92
781.0500.80	CHAUF.EAU CHAUFFEO .BL.VM 200L 021117	U	300MO.1	637,92	11,92
781.0410.40	CHAUF.EAU CHAUFFEO .BL.VM 75L 021113	U	300LU.1	524,92	11,92

atlantic

CHAUFFEO - RESISTANCE BLINDEE

Chauffe-eau vertical mural - Compact - Ø 567



	DÉSIGNATION	UT	CODE	PPHT (€)	ECOPART (€)
781.0354.00	CHAUF.EAU CHAUFFEO BL.VM CP 100L 021225	U	338P8.7	483,92	11,92
781.0410.25	CHAUF.EAU CHAUFFEO BL.VM CP 150L 021226	U	338P9.5	558,92	11,92
781.0469.50	CHAUF.EAU CHAUFFEO BL.VM CP 200L 021227	U	338PA.2	637,92	11,92

Le PPHT comprend l'ecopart (€)

PRODUCTION D'EAU CHAUDE SANITAIRE

CHAUFFE-EAU ELECTRIQUE

atlantic



CHAUFFEO - RESISTANCE BLINDEE

Chauffe-eau horizontal mural



	DÉSIGNATION	UT	CODE	PPHT (€)	ECOPART (€)
781.0621.00	CHAUF.EAU CHAUF.BL.HM RAC DESS.100L MO 023172	U	349L5.8	839,92	11,92
781.0740.25	CHAUF.EAU CHAUF.BL.HM RAC DESS.150L MO 023178	U	348X8.8	998,92	11,92
781.0840.00	CHAUF.EAU CHAUF.BL.HM RAC DESS.200L MO 023193	U	349L3.3	1131,92	11,92
781.0587.20	CHAUF.EAU CHAUF.BL.HM RACC DESS 75L MO 023152	U	353SN.2	745,92	11,92
781.0599.25	CHAUF.EAU CHAUF. BL.HM RACC COTE75L MO 025108	U	354WU.3	810,92	11,92
781.0667.50	CHAUF.EAU CHAUF.BL.HM RAC COTE 100L MO 025109	U	349L9.0	901,92	11,92
781.0789.75	CHAUF.EAU CHAUF.BL.HM RAC COTE 150L MO 025122	U	348XB.1	1064,92	11,92
781.0852.00	CHAUF.EAU CHAUF.BL.HM RAC COTE 200L MO 025118	U	349L6.6	1147,92	11,92

atlantic



CHAUFFEO - RESISTANCE BLINDEE

Chauffe-eau vertical sur socle



	DÉSIGNATION	UT	CODE	PPHT (€)	ECOPART (€)
781.0998.00	CHAUF.EAU CHAUFFEO BL.VS 200L 2200M MO 022121	U	325Z9.2	1009,92	11,92
781.0730.50	CHAUF.EAU CHAUFFEO BL.VS 300L 3000M MO 022122	U	325ZB.7	985,92	11,92
781.0917.25	CHAUF.EAU CHAUFFEO BL.VS 300L 3300TC 022123	U	325ZC.5	1234,92	11,92

atlantic



IMMENSIO VERTICAL SUR SOCLE

Chauffe-eau électrique 5000TC



	DÉSIGNATION	UT	CODE	PPHT (€)	ECOPART (€)
781.2977.00	CHAUF.EAU IMMENSIO V.SOCLE BLINDE 500L 022826	U	431K6.3	2988,92	11,92

atlantic



LINEO CONNECTE - RESISTANCE STEATITE

Chauffe-eau électrique plat/carré - Multiposition - Blanc



	DÉSIGNATION	UT	CODE	PPHT (€)	ECOPART (€)
789.0518.40	CHAUF.EAU LINEO CONN.ST.MULTI. BLC 40L 157205	U	299AF.4	659,92	11,92
789.0549.60	CHAUF.EAU LINEO CONN.ST.MULTI.BLC 65L 157207	U	299AG.2	698,92	11,92
789.0589.60	CHAUF.EAU LINEO CONN.ST.MULTI.BLC 80LM0157209	U	299AH.0	748,92	11,92
000.0660.80	CHAUF.EAU LINEO CONN.ST.MULT.BLC100LMO 157216	U	A015M.5	837,92	11,92

PRODUCTION D'EAU CHAUDE SANITAIRE

CHAUFFE-EAU ELECTRIQUE

atlantic



LINEO CONNECTE - RESISTANCE STEATITE

Chauffe-eau électrique plat/carré - Carré vertical mural - Blanc



	DÉSIGNATION	UT	CODE	PPHT (€)	ECOPART (€)
789.0640.00	CHAUF.EAU LINEO CONN.ST.CAR VM BLC100 157213	U	299AJ.7	811,92	11,92
789.0693.60	CHAUF.EAU LINEO CONN.ST.CAR VM BLC120L 157214	U	299AK.5	878,92	11,92
789.0748.80	CHAUF.EAU LINEO CONN.ST.CAR.VM BLC150L 157215	U	299AL.3	947,92	11,92

atlantic



ODEO - ULTRA COMPACT

Chauffe-eau d'appoint - Sous évier



	DÉSIGNATION	UT	CODE	PPHT (€)	ECOPART (€)
000.0233.25	CHAUF.EAU ODEO 15L SUR EVIER COMPACT 821501	U	349LB.5	322,92	11,92
000.0233.25	CHAUF.EAU ODEO 15L SOUS EVIER COMPACT 821502	U	349LE.8	322,92	11,92

atlantic



ODEO - ULTRA COMPACT

Chauffe-eau d'appoint - Sur évier



	DÉSIGNATION	UT	CODE	PPHT (€)	ECOPART (€)
000.0276.00	CHAUF.EAU ODEO 30L 2000M SUR EVIER 831232	U	348XD.7	379,92	11,92

atlantic



ZENEO - RESISTANCE STEATITE

Chauffe-eau vertical mural



	DÉSIGNATION	UT	CODE	PPHT (€)	ECOPART (€)
789.0463.40	CHAUF.EAU ZENEO ACI HYB.VM 50L 153105	U	11424.9	673,92	11,92
789.0568.00	CHAUF.EAU ZENEO ACI HYB.VM 75L 153108	U	300LS.6	721,92	11,92
789.0612.00	CHAUF.EAU ZENEO ACI HYB.VM MONO 100L C 153109	U	299AM.1	776,92	11,92
789.0696.80	CHAUF.EAU ZENEO ACI HYB.VM MONO 150L C 153111	U	299AN.9	882,92	11,92
789.0797.60	CHAUF.EAU ZENEO ACI HYB.VM MONO 200L C 153112	U	299AP.7	1008,92	11,92
789.0573.75	CHAUF.EAU ZENEO ACI HYB.ST.VM CP 100LM 156211	U	338PC.8	776,92	11,92
789.0653.25	CHAUF.EAU ZENEO ACI HYB.ST.VM CP 150LM 156212	U	338PD.6	882,92	11,92

atlantic



ZENEO - RESISTANCE STEATITE

Chauffe-eau vertical sur socle



	DÉSIGNATION	UT	CODE	PPHT (€)	ECOPART (€)
789.0931.50	CHAUF.EAU ZENEO ACI HYB.VS 150L 154316	U	318VU.9	1253,92	11,92

Le PPHT comprend l'ecopart (€)

Les tarifs et disponibilités de nos produits peuvent évoluer sans préavis

RICHARDSON

153

PRODUCTION D'EAU CHAUDE SANITAIRE

CHAUFFE-EAU ELECTRIQUE

atlantic

ZENEO - RESISTANCE STEATITE

Chauffe-eau vertical sur socle
- suite



	DÉSIGNATION	UT	CODE	PPHT (€)	ECOPART (€)
789.1056.00	CHAUF.EAU ZENEO ACI HYB.VS 200L 154317	U	318VW.5	1419,92	11,92
789.1092.00	CHAUF.EAU ZENEO ACI HYB.VS 250L 154318	U	313HK.7	1467,92	11,92
789.1242.75	CHAUF.EAU ZENEO ACI HYB.VS 300L 154319	U	318VY.1	1668,92	11,92

atlantic

ZENEO - RESISTANCE STEATITE

Chauffe-eau horizontal mural

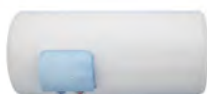

	DÉSIGNATION	UT	CODE	PPHT (€)	ECOPART (€)
789.0729.75	CHAUF.EAU ZENEO ACI HYB.HM DESS.100L 155411	U	349KZ.0	984,92	11,92
789.0871.50	CHAUF.EAU ZENEO ACI HYB.HM DESS.150L 155412	U	349KA.8	1173,92	11,92
789.1016.25	CHAUF.EAU ZENEO ACI HYB.HM DESS.200L 155413	U	349MQ.6	1366,92	11,92

atlantic

PETITE CAPACITE VISIO - RESISTANCE BLINDEE

PC - Chauffe-eau série étroite sur évier - Ø raccordement hydraulique 1/2"



	DÉSIGNATION	UT	CODE	PPHT (€)	ECOPART (€)
000.0235.90	CHAUF.EAU BL.PC ETR SUR EV. 30L MO 321104	U	70968.3	348,92	11,92
781.0330.40	CHAUF.EAU BL.PC ETR SUR EV 50L MO 327106	U	72326.2	483,92	11,92

atlantic

PETITE CAPACITE VISIO - RESISTANCE BLINDEE

PC - Chauffe-eau série compacte sur et sous évier - Ø raccordement hydraulique 1/2"



	DÉSIGNATION	UT	CODE	PPHT (€)	ECOPART (€)
000.0202.30	CHAUF.EAU BL.PC COMP SUR EV. 15L MO 325216	U	70523.6	300,92	11,92
000.0202.30	CHAUF.EAU BL.PC COMPSS EV.15L MO 326216	U	70526.9	300,92	11,92

PRODUCTION D'EAU CHAUDE SANITAIRE

CHAUFFE-EAU - CHAUFFE BAIN GAZ

elm.leblanc

ONDEA BAS NOX

Chauffe-bain - brûleur à flamme refroidie - Cheminée



	DÉSIGNATION	UT	CODE	PPHT (€)	ECOPART (€)
790.0628.50	CHAUF.BAIN ONDEA HYDROPOW.PVN 10L 7736505691	U	213WP.2	839,67	1,67

elm.leblanc

ONDEA HYDROPOWER BAS NOX

Chauffe-bain - allumage Hydropower - Tirage naturel



	DÉSIGNATION	UT	CODE	PPHT (€)	ECOPART (€)
504.0820.80	CHAUF.BAIN ONDEA HYDRO.PVHYN 10L 7736504844	U	213WU.1	1027,67	1,67
790.0996.00	CHAUF.BAIN ONDEA HYDRO.PVHYN 11L 7736504817	U	351KG.1	996,67	1,67

elm.leblanc

ONDEA HYDROPOWER BAS NOX

Cheminée spéciale VMC sans veilleuse - 9 litres / minutes



	DÉSIGNATION	UT	CODE	PPHT (€)	ECOPART (€)
790.0968.00	CHAUF.BAIN ONDEA HYDRO.PVHYN 9L 7736504815	U	351K9.7	969,67	1,67

elm.leblanc

ACCESSOIRES

Accessoires



	DÉSIGNATION	UT	CODE	PPHT (€)	ECOPART (€)
551.0041.25	KIT MELANGEUR POUR LC10/LC11 7709003525	U	3625C.3	55,00	

Saunier Duval

CHAUFFE-BAINS OPALIA

Gaz Naturel - Avec veilleuse - Cheminée



	DÉSIGNATION	UT	CODE	PPHT (€)	ECOPART (€)
790.0720.00	CHAUF.BAINS OPALIA C11 GN AV.VEILL 0010022532	U	196NL.8	961,67	1,67
790.0796.50	CHAUF.BAINS OPALIA C14 GN AV.VEILL 0010022538	U	196T2.8	1063,67	1,67

Saunier Duval

CHAUFFE-BAINS OPALIA

Gaz Naturel - sans veilleuse - allumage par générateur hydroélectrique - Cheminée



	DÉSIGNATION	UT	CODE	PPHT (€)	ECOPART (€)
790.0877.50	CHAUF.BAINS OPALIA C11 GN SS.VEILL 0010022536	U	196T1.0	1171,67	1,67

Le PPHT comprend l'ecopart (€)

PRODUCTION D'EAU CHAUDE SANITAIRE

CHAUFFE-EAU - CHAUFFE BAIN GAZ



CHAUFFE-BAINS OPALIA

Butane/Propane - avec veilleuse - Cheminée



	DÉSIGNATION	UT	CODE	PPHT (€)	ECOPART (€)
790.0720.00	CHAUF.BAINS OPALIA C11 P AV.VEILL. 0010022533	U	196SZ.3	961,67	1,67



CHAUFFE-BAINS OPALIA

Butane/Propane - sans veilleuse - cheminée



	DÉSIGNATION	UT	CODE	PPHT (€)	ECOPART (€)
790.0877.50	CHAUF.BAINS OPALIA C11 P SS.VEILL. 0010022537	U	204SZ.6	1171,67	1,67



ACCESSOIRES

Kit remplacement



	DÉSIGNATION	UT	CODE	PPHT (€)
790.0020.25	KIT ADAPTAT LEBLANC LM26-OPALIA C 0020234586	U	210Z0.5	27,00

GRUPE DE SECURITE ET ACCESSOIRES



JOINT

A lèvres - Extérieur



	DÉSIGNATION	UT	CODE	PPHT (€)
015.0011.08	JOINT A LEVRE D.82MM 099060	U	28617.9	13,03



KIT ELECTRIQUE

Pour Chauffe-électrique



	DÉSIGNATION	UT	CODE	PPHT (€)
025.0058.00	KIT TRIPHASE 400V P/KITABLE ACI 009134	U	89117.6	58,00
025.0155.00	KIT TRI CHAUFFEO PLUS VM 200L ET VS 009250	U	339V8.9	155,00

PRODUCTION D'EAU CHAUDE SANITAIRE

GRUPE DE SECURITE ET ACCESSOIRES



PLATINE ELECTRONIQUE

Pour Chauffe-eau ACI



	DÉSIGNATION	UT	CODE	PPHT (€)
015.0117.84	THERMOSTAT ELEC. NON KITABLE 070213	U	2521K.4	117,84



RESISTANCE ELECTRIQUE D'APPOINT

Platine thermoplongeur - Mono



	DÉSIGNATION	UT	CODE	PPHT (€)
015.0090.07	RESISTANCE BLINDE 1200W 230V 50-100L 099003	U	28091.7	105,96
015.0099.58	PLATINE TH-PLONGEUR 1200W 100L MO.099083	U	63774.4	117,15
015.0095.55	RESISTANCE BLINDE 1650W 230V 099004	U	33697.4	112,41
015.0101.08	PLATINE TH-PLONGEUR 2200W 150-200L MO.099005	U	28626.0	118,92
015.0134.01	PLATINE TH-PLONGEUR 3000W 250-300L MO.099007	U	58632.1	157,66



RESISTANCE ELECTRIQUE D'APPOINT

Résistance blindée - Avec anode + joint



	DÉSIGNATION	UT	CODE	PPHT (€)
015.0078.55	RESISTANCE BLINDE 1200W 230V +JT +ANOD 060185	U	3361B.3	78,55
015.0085.31	RESISTANCE BLINDE 1600W 230V 060186	U	7253T.1	85,31



MONTAGE, FIXATION ET PORTAGE

Kit d'accroche plafond



	DÉSIGNATION	UT	CODE	PPHT (€)	ECOPART (€)
025.0122.25	CONSOLE ACCROCH.PLAFOND VM 150A200L 009105	U	68723.6	163,26	0,26



MONTAGE, FIXATION ET PORTAGE

Console de fixation universelle



	DÉSIGNATION	UT	CODE	PPHT (€)	ECOPART (€)
025.0030.00	CONSOLE FIXATION UNIVERSELLE 009124	U	89014.5	40,06	0,06

Le PPHT comprend l'ecopart (€)

PRODUCTION D'EAU CHAUDE SANITAIRE

GRUPE DE SECURITE ET ACCESSOIRES

atlantic

MONTAGE, FIXATION ET PORTAGE

Kit de cerclage - Pour fixation au plafond



	DÉSIGNATION	UT	CODE	PPHT (€)	ECOPART (€)
025.0035.25	KIT DE CERCLAGE P/CHAUF.EAU HM 75-200L 009115	U	16929.2	47,06	0,06

atlantic

MONTAGE, FIXATION ET PORTAGE

Cache-piquages - Pour Linéo Connecté

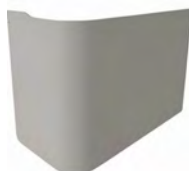

	DÉSIGNATION	UT	CODE	PPHT (€)	
000.0045.00	CACHE-PIQUAGE LINEO CONN.40-65-80L BLC 341068	U	174CV.7	45,00	
587.0055.00	CACHE-PIQUAGE LINEO CONN.100-120L BLC 341070	U	174CS.4	55,00	
789.0059.00	CACHE-PIQUAGE LINEO CONN.100-150L BLC 341083	U	300M3.5	59,00	

atlantic

MONTAGE, FIXATION ET PORTAGE

Portage - Pack ventouses. EasyGrip



	DÉSIGNATION	UT	CODE	PPHT (€)	
674.0176.00	VENTOUSE DE PORTAGE EASYGRIP 009240	U	174GC.0	176,00	

atlantic

MONTAGE, FIXATION ET PORTAGE

Trépied et réhausse - Trépied



	DÉSIGNATION	UT	CODE	PPHT (€)	ECOPART (€)
025.0055.00	TREPIED UNIVERSEL ATL 009243	U	276C2.9	55,20	0,20

atlantic

MONTAGE, FIXATION ET PORTAGE

Trépied et réhausse - Réhausse



	DÉSIGNATION	UT	CODE	PPHT (€)	ECOPART (€)
025.0090.40	REHAUSSE POUR CHAUFFE-EAU VS 150-300L 009242	U	170A7.5	113,16	0,16

PRODUCTION D'EAU CHAUDE SANITAIRE

GRUPE DE SECURITE ET ACCESSOIRES

comap

GRUPE DE SECURITE

Reverso - Liaison au chauffe-eau par raccord tournant



	DÉSIGNATION	UT	CODE	PPHT (€)	ECOPART (€)
650.0082.44	GRUPE DE SECURITE REVERSO 3/4 890506	U	86137.7	109,94	0,02

comap

GRUPE DE SECURITE

Droit



	DÉSIGNATION	UT	CODE	PPHT (€)	ECOPART (€)
650.0014.96	GRUPE SECURITE ANTIP.3/4" 889006-01	U	5627D.4	19,97	0,02

comap

GRUPE DE SECURITE

Droit Inox



	DÉSIGNATION	UT	CODE	PPHT (€)	ECOPART (€)
650.0052.22	GRUPE SECURITE 3/4" SIEGE INOX R110007001	U	94686.1	65,29	0,02

comap

GRUPE DE SECURITE

Coudé



	DÉSIGNATION	UT	CODE	PPHT (€)	ECOPART (€)
650.0062.94	GRUPE SECURITE 3/4" COUDE SIEGE INOX 889216	U	8264P.4	78,69	0,02

comap

ACCESSOIRES

Siphon - Siphon de groupe sécurité



	DÉSIGNATION	UT	CODE	PPHT (€)	ECOPART (€)
650.0002.88	SIPHON NF 1" DEFLECTEUR HAUT 8877 887718	U	214H1.7	2,89	0,01



ANODE

Anode magnésium - AZ63



	DÉSIGNATION	UT	CODE	PPHT (€)	
500.0015.34	ANODE MAGNESIUM DN26 L400 DIFF 807260	U	90290.8	20,46	

Le PPHT comprend l'ecopart (€)

PRODUCTION D'EAU CHAUDE SANITAIRE

GRUPE DE SECURITE ET ACCESSOIRES



RESISTANCE STEATITE

Tête carrée



	DÉSIGNATION	UT	CODE	PPHT (€)
500.0071.84	RESISTANCE STEAT.CARR.900W M.ATL.DIFF 807239	U	0402V.1	95,79
500.0051.50	RESISTANCE STEAT.CARR.1200W M.ATL. 807246	U	6424I.6	68,66
500.0052.55	RESISTANCE STEAT.CARR.1800W M.ATL.DIFF 807243	U	8260G.3	70,07
500.0105.07	RESISTANCE STEAT.CARR.2400W M.ATL. 807244	U	82615.6	140,09
500.0111.02	RESISTANCE STEAT.CABL.3000W T.ATL DIFF 807255	U	3816A.6	138,77



THERMOSTAT

A bulbe - BSD standard



	DÉSIGNATION	UT	CODE	PPHT (€)
500.0094.06	THERMOSTAT A BULBE BSD 370 TRIP. DIFF 703550	U	85223.6	125,41



THERMOSTAT

A canne - A plonge - Monophasé - Type TAS



	DÉSIGNATION	UT	CODE	PPHT (€)
500.0035.54	THERMOSTAT TAS 300 DIFF 703600	U	29505.5	47,38



THERMOSTAT

A canne - A plonge - Triphasé



	DÉSIGNATION	UT	CODE	PPHT (€)
500.0105.64	THERMOSTAT CE TAS TF 450 DIFF 703625	U	62527.7	140,85



THERMOSTAT

A canne - A plonge - Monophasé - Type TUS

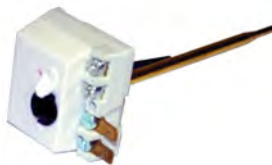

	DÉSIGNATION	UT	CODE	PPHT (€)
500.0073.57	THERMOSTAT TUS 370 DIFF 703515	U	76880.4	98,09
500.0061.72	THERMOSTAT TUS 270 DIFF 703510	U	23399.9	82,29

PRODUCTION D'EAU CHAUDE SANITAIRE

GRUPE DE SECURITE ET ACCESSOIRES



THERMOSTAT

A canne - Embrochable - Type TSE



	DÉSIGNATION	UT	CODE	PPHT (€)
500.0022.58	THERMOSTAT A CANNE TSE 270 90 DIFF 703527	U	43613.9	30,11



SIPHON

Pour groupe de sécurité - Non réglable en hauteur



	DÉSIGNATION	UT	CODE	PPHT (€)	ECOPART (€)
650.0004.06	SIPHON GROUPE SECU.COMP.G1X5/4 GS008 0201169	U	67624.7	4,08	0,02



GRUPE DE SECURITE

Groupe de sécurité - Groupe coudé 3/4" - Manette soupape rouge



	DÉSIGNATION	UT	CODE	PPHT (€)	ECOPART (€)
653.0038.40	GROUPE SECURITE COUDE 3/4 NF GS20C	U	2526A.9	48,02	0,02



GRUPE DE SECURITE

Groupe de sécurité - Groupe coudé 1"



	DÉSIGNATION	UT	CODE	PPHT (€)	ECOPART (€)
653.0141.75	GROUPE SECURITE 1" GS26	U	94042.9	189,02	0,02



VASE D'EXPANSION SANITAIRE

Vexbal



	DÉSIGNATION	UT	CODE	PPHT (€)
653.0054.75	VASE D'EXPANSION SANIT.VEXBAL 5L VEX05	U	57066.3	73,00
653.0058.20	VASE D'EXPANSION SANIT.VEXBAL 8L VEX08	U	44424.0	77,60
653.0069.52	VASE D'EXPANSION SANIT.VEXBAL 12L VEX11	U	57079.6	92,70
653.0078.75	VASE D'EXPANSION SANIT.VEXBAL 18L VEX18	U	3664C.5	105,00



VASE D'EXPANSION SANITAIRE

Kit de branchement - Vexbal



	DÉSIGNATION	UT	CODE	PPHT (€)
653.0034.05	KIT DE BRANCHEMENT P.VEXBAL 5 A 12 L ZKVEK	U	01008.2	45,40

Le PPHT comprend l'ecopart (€)

Les tarifs et disponibilités de nos produits peuvent évoluer sans préavis

RICHARDSON

| 157 |

PRODUCTION D'EAU CHAUDE SANITAIRE

GRUPE DE SECURITE ET ACCESSOIRES

WATTS

GRUPE DE SECURITE

SFR - Kit de sécurité



	DÉSIGNATION	UT	CODE	PPHT (€)	ECOPART (€)
650.0121.42	KIT SECURITE ECO 2254608	U	8084B.8	161,90	0,01

WATTS

REDUCTEUR DE PRESSION

Rédubar - MF - Ecrrou tournant



	DÉSIGNATION	UT	CODE	PPHT (€)	ECOPART (€)
650.0022.63	REDUCTEUR PRESSION REDUBAR ECR.T.3/4" 2282500	U	2293J.2	45,26	0,01

WATTS

EQUIPEMENT

RLT - Limiteur de température



	DÉSIGNATION	UT	CODE	PPHT (€)	ECOPART (€)
650.0075.58	LIMITEUR DE TEMP.RLT M2 2297009M2	U	28027.1	100,78	0,01

WATTS

RACCORD ISOLANT DIELECTRIQUE

MF



	DÉSIGNATION	UT	CODE	PPHT (€)	ECOPART (€)
650.0014.86	RACCORD ISOLANT DIELECTRIQUE MF 3/4" 2224332	U	63778.5	19,82	0,01

WATTS

RACCORD ISOLANT DIELECTRIQUE

FM



	DÉSIGNATION	UT	CODE	PPHT (€)	ECOPART (€)
650.0016.16	RACCORD ISOLANT DIELECTR.FM 1/2" -3/4" 2224347	U	0454F.8	21,55	0,01

WATTS

RACCORD ISOLANT DIELECTRIQUE

FF



	DÉSIGNATION	UT	CODE	PPHT (€)	ECOPART (€)
650.0051.88	RACCORD ISOLANT DIELECTRIQUE FF 3/4" 2224312	U	37558.4	69,18	0,01
650.0087.58	RACCORD ISOLANT DIELECTRIQUE FF 1" 2224313	U	86147.6	116,78	0,01
650.0134.44	RACCORD ISOLANT DIELECTRIQUE FF 1"1/4 2224314	U	54647.3	179,27	0,01
650.0221.47	RACCORD ISOLANT DIELECTRIQUE FF 1"1/2 2224315	U	37576.6	295,30	0,01
650.0253.62	RACCORD ISOLANT DIELECTRIQUE FF 2" 2224316	U	37600.4	338,17	0,01

Pour plus d'infos,
consultez
le CAHIER TECHNIQUE
page 14

greensolutions

Votre partenaire énergie



SIMULEZ VOS AIDES EN QUELQUES CLICS



Une seule démarche pour bénéficier de l'ensemble des aides éligibles



Une hotline dédiée vous accompagne dans vos démarches



Chaque dossier est contrôlé pour garantir le paiement des primes



Une facture allégée en déduisant l'ensemble des aides éligibles



Toutes les aides éligibles grâce au simulateur de primes



Toutes les actualités de la rénovation énergétique

Retrouvez chez RICHARDSON les produits éligibles aux aides :



Pompe à chaleur air/eau



Chauffe-eau thermo-dynamique



Poêle à granulés



Chaudière à bois



VMC simple et double flux

www.richardson.fr/services/green-solutions

Hotline

06 27 52 64 95

MCR 2

Toujours MCR, maintenant réinventée.



Compacte avec 2 dimensions
40 cm et 60 cm pour le modèle BIC

Silencieuse
grâce à son isolation acoustique



Système de remplissage « Easy-Fill »
remplissage facile en eau, en toute autonomie en cas de besoin



Tableau de commande E-PILOT
intuitif et ergonomique

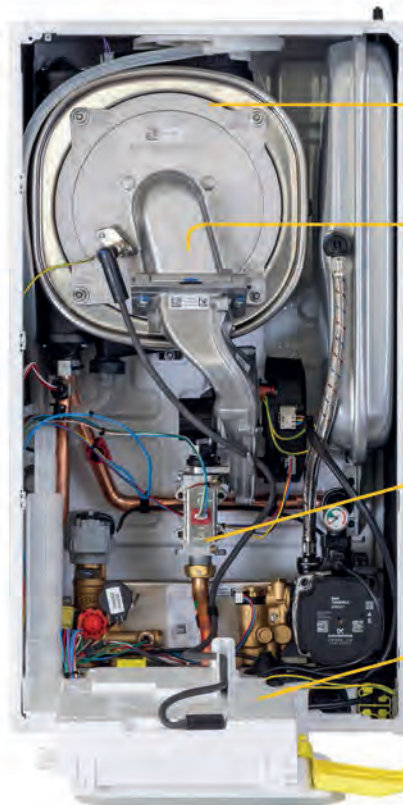

Corps de chauffe en Inox
fiable et qualitatif

Brûleur modulant de 10 à 100%
meilleure performance et augmentation de la durée de vie de la chaudière



Contrôle de la combustion automatique pour réduire les émissions de CO2



Qualité prouvée
corps hydraulique en laiton tubes cuivre



Compatible thermostat connecté Smart TC avec ou sans fil
pour plus de confort et d'économies



FABRICANT FRANÇAIS
DEPUIS 1684

www.dedietrich-thermique.fr

De Dietrich

Chauffage

SOMMAIRE

ECO ENERGIES

ACCESSOIRES SOLAIRE	162
---------------------------	-----

CHAUDIERE

CHAUDIERE MURALE A CONDENSATION	162
CHAUDIERE MURALE	164
ACCESSOIRES DE CHAUDIERE	165

ACCESSOIRES DE CHAUFFAGE

EQUILIBRAGE	167
EXPANSION	167
SECURITE	168
MESURE	168
ACCESSOIRES DE CHAUFFERIE	169
ACCESSOIRES FIOUL	170
TRAITEMENT DES EAUX DE CHAUFFAGE	170

BRULEUR

BRULEUR FIOUL - PETITE PUISSANCE	172
ACCESSOIRES DE BRULEUR	172

CIRCULATEUR

CIRCULATEUR DOMESTIQUE	172
CIRCULATEUR PETIT COLLECTIF ET COLLECTIF	172
CIRCULATEUR BOUCLAGE ECS	172
ACCESSOIRES DE CIRCULATEUR	173

REGULATION

REGULATION ELECTRONIQUE ET MECANIQUE	173
--	-----

CONDUIT DE FUMEE

CHEMINEE	176
VENTOUSE	178
VENTOUSE CONDENSATION	178
ACCESSOIRES DE FUMISTERIE	182

RADIATEUR

RADIATEUR ACIER	184
RADIATEUR ALU	184
RADIATEUR DECORATIF	185
RADIATEUR ELECTRIQUE	185
RADIATEUR SECHE-SERVIETTES	185

PLANCHER CHAUFFANT

DALLE	187
ACCESSOIRES DE PLANCHER CHAUFFANT	187

ROBINET ET ACCESSOIRES RADIATEUR

ROBINET DECOR	188
ROBINET THERMOSTATIQUE	188
ROBINET THERMOSTATISABLE	189
ROBINET MANUEL	190
COUDE, TE DE REGLAGE, RACCORD ET DIVERS	190
ACCESSOIRES RADIATEUR	191

POMPE A CHALEUR

POMPE A CHALEUR	192
ACCESSOIRES POMPE A CHALEUR	193

STOCKAGE FIOUL ET ACCESSOIRES

ACCESSOIRES FIOUL	195
-------------------------	-----

PIECES DE RECHANGE CHAUFFE-EAU

CHAUFFE-EAU	195
-------------------	-----

ECO ENERGIES

ACCESSOIRES SOLAIRE



ACCESSOIRES SOLAIRES

Purgeur



	DÉSIGNATION	UT	CODE	PPHT (€)
653.0034.20	PURGEUR HAUTE TEMPERATURE 3/8 250031 PRHT	U	3160C.4	45,60



ACCESSOIRES SOLAIRES

Vanne d'isolement



	DÉSIGNATION	UT	CODE	PPHT (€)
653.0010.72	VANNE A SPHERE 3/8 HTE TEMP. 250300 ZVS12HT	U	0468G.0	14,30

J+0 100% Dispo



SCANNEZ, commandez,

Téléchargez sur

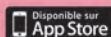

CHAUDIERE

CHAUDIERE MURALE A CONDENSATION



MCR 2

Chaudière murale gaz condensation - Pour chauffage et eau chaude sanitaire micro-accumulé



	DÉSIGNATION	UT	CODE	PPHT (€)	ECOPART (€)
553.2400.00	CHAUD.MURALE GAZ COND.MCR2 30 MI 7838805	U	A09FY.4	3205,00	5,00



VIVADENS MCR

Chaudière nue - Pour chauffage et production d'eau chaude sanitaire



	DÉSIGNATION	UT	CODE	PPHT (€)	ECOPART (€)
547.3388.49	CHAUD.GAZ.COND.MCR 24/28 BIC+ HG162 7792959	U	350A6.5	4522,99	5,00



ACLEA BAS NOX

Chaudière nue - Pour chauffage et eau chaude micro-accumulée - VMC



	DÉSIGNATION	UT	CODE	PPHT (€)	ECOPART (€)
554.2142.99	CHAUD.ACLEA BAS NOX 23KW VMC-NGLM 7716705093	U	200R0.4	2147,99	5,00



ACLEA BAS NOX

Chaudière nue - Pour chauffage et eau chaude micro-accumulée - Cheminée



	DÉSIGNATION	UT	CODE	PPHT (€)	ECOPART (€)
554.2098.00	CHAUD.ACLEA BAS NOX 24KW CHEMINEE 7716705092	U	200R4.6	2103,00	5,00



ACLEIS CONDENS

Chaudière nue - Pour chauffage et eau chaude micro-accumulée - VMC



	DÉSIGNATION	UT	CODE	PPHT (€)	ECOPART (€)
552.1607.24	CHAUD.ACLEIS BNOX VMC NGLM 23KW 7716705084	U	175R8.1	2147,99	5,00



MEGALIS CONDENS

Chaudière nue - Pour chauffage et eau chaude sanitaire micro-accumulée



	DÉSIGNATION	UT	CODE	PPHT (€)	ECOPART (€)
551.2313.00	CHAUD.MEGALIS CO.V.M.NU GVAC25-1MN 7738100334	U	4165P.3	3089,00	5,00

Le PPHT comprend l'ecopart (€)

CHAUDIERE

CHAUDIERE MURALE A CONDENSATION



ODEALIS CONDENS

Chaudière nue - Pour chauffage et eau chaude intégrée - Murale



	DÉSIGNATION	UT	CODE	PPHT (€)	ECOPART (€)
554.2628.79	CHAUD.COND.ODEALIS GVT C 24-2 NUE 7716701528	U	248UG.5	3290,99	5,00



OXYLIA ICONDENS

Chaudière ultra compacte



	DÉSIGNATION	UT	CODE	PPHT (€)	ECOPART (€)
554.1713.75	CHAUD.GAZ.MUR.OXYLIA COND.18KW 12L 7716704754	U	416N8.7	2290,00	5,00
554.1889.98	CHAUD.GAZ.MUR.OXYLIA COND.24KW 14L 7716704756	U	416N9.5	2524,98	5,00



OXYLIS ICONDENS

Chaudière ultra compacte



	DÉSIGNATION	UT	CODE	PPHT (€)	ECOPART (€)
551.1713.75	CHAUD.MUR.OXYLIS ICONDENS 18/24KW 7716704750	U	A02UP.9	2290,00	5,00
551.1889.99	CHAUD.MUR.OXYLIS ICONDENS 24/30KW 7716704752	U	A02UQ.7	2524,99	5,00



HYDROCONFORT CONDENSATION - VISIO

Chaudière murale - Pour chauffage et production d'ECS - Raccord circuit chauffage supplémentaire



	DÉSIGNATION	UT	CODE	PPHT (€)	ECOPART (€)
555.3638.98	CHAUD. HYDROCONFORT COND. 20KW 80L A4AJ20020	U	98972.3	4856,98	5,00



ISOMAX CONDENS

Chaudière complète - Pour chauffage et production d'eau chaude sanitaire accumulée dynamique - Ventouse



	DÉSIGNATION	UT	CODE	PPHT (€)	ECOPART (€)
558.3570.75	CHAUD.CON.MU.ISOMAX T 31-CS/1 31KW 0010025208	U	308MM.8	4766,00	5,00



ISOMAX CONDENS

Chaudière mixte avec 2 ballons de 21 litres, régulateur, sonde ext.de série - Ventouse



	DÉSIGNATION	UT	CODE	PPHT (€)	ECOPART (€)
558.5002.98	CHAUD.MIXTE ISOMAX 35 GN/P 35KW 0010025209	U	269MC.2	5007,98	5,00

Le PPHT comprend l'ecopart (€)

CHAUDIERE

CHAUDIERE MURALE A CONDENSATION



ISOTWIN CONDENS

Chaudière nue - Pour chauffage et eau chaude accumulée dynamique - Ventouse



	DÉSIGNATION	UT	CODE	PPHT (€)	ECOPART (€)
558.3075.75	CHAUD.ISOTWIN COND.T 26-CS/1 NUE 0010025210	U	307SN.8	4106,00	5,00
558.3351.75	CHAUD.CON.MU.ISOTWIN T31-CS/1 31KW 0010025212	U	308MN.6	4474,00	5,00



SEMIFAST CONDENS

Chaudière nue - Pour chauffage et eau chaude micro-accumulée - Ventouse



	DÉSIGNATION	UT	CODE	PPHT (€)	ECOPART (€)
558.1726.19	CHAUD.SEMIFAST CONDENS F 25 0010016081	U	6483W.8	2470,99	5,00
558.2130.74	CHAUD.SEMIFAST CONDENS F 30 0010016082	U	6483X.6	2845,99	5,00



THEMA CONDENS

Chaudière complète - Pour chauffage et production d'eau chaude instantanée - Ventouse



	DÉSIGNATION	UT	CODE	PPHT (€)	ECOPART (€)
558.2942.99	CHAUD.COND.CHAUFF.SEUL 25KW GN 0010025101	U	309UL.6	2947,99	5,00



THEMA FAST CONDENS

Chaudière nue - Pour chauffage et production d'eau chaude sanitaire micro-accumulée - Ventouse



	DÉSIGNATION	UT	CODE	PPHT (€)	ECOPART (€)
558.1956.50	CHAUD.THEMAFAST CONDENS.F25 GN NUE 0010021498	U	9141A.9	2800,00	5,00
558.2211.29	CHAUD.THEMAFAST CONDENS F 30-A 0010017417	U	6483N.5	3163,99	5,00



THEMA FAST CONDENS

Chaudière à condensation mixte - Micro-accumulation avec technologie FlameFit pour une combustion optimisée en temps réel



	DÉSIGNATION	UT	CODE	PPHT (€)	ECOPART (€)
558.2075.49	CHAUD.COND.MIXTE 26KW GN 12.3L/M 0010025102	U	353T.3	2969,99	5,00

CHAUDIERE

CHAUDIERE MURALE A CONDENSATION



THEMA PLUS CONDENS

Chaudière nue - Pour chauffage et production d'eau chaude micro-accumulée - Ventouse



	DÉSIGNATION	UT	CODE	PPHT (€)	ECOPART (€)
558.2216.24	CHAUD.THEMAPLUS COND.F 25 GN NUE 0010021497	U	8038X.2	2959,99	5,00
558.2321.90	CHAUD.THEMAPLUS COND.F 30-A GN NUE 0010017388	U	64836.0	3322,00	5,00



THEMA PLUS CONDENS

Chaudière complète - Pour chauffage et production d'ECS micro-accumulée - Ventouse



	DÉSIGNATION	UT	CODE	PPHT (€)	ECOPART (€)
558.2349.00	CHAUD.COND.MIXTE 26KW GN THEMA+ 0010025107	U	308MT.6	3137,00	5,00
558.2624.24	CHAUD.COND.MIXTE 31KW GN 14.8L/M 0010025109	U	308MY.5	3503,98	5,00
558.2900.25	CHAUD.CON.MU.THEMA MA 36-CS/1 31KW 0010025111	U	308NO.3	3872,00	5,00

CHAUDIERE MURALE



ACLEIS BAS NOX

Chaudière nue BT faible émission - Chauffage et eau chaude instantanée - Tirage naturel (Cheminée)



	DÉSIGNATION	UT	CODE	PPHT (€)	ECOPART (€)
552.1573.49	CHAUD.ACLEIS BAS NOX NGLM24 24KW 7716705075	U	2420V.5	2102,99	5,00



EGALIS BASSE TEMPERATURE

Chaudière nue - Pour chauffage seul avec option ballon - Ventouse



	DÉSIGNATION	UT	CODE	PPHT (€)	ECOPART (€)
554.2817.99	CHAUD.MUR.CON.EGALIS N GVS IC 22 7716704737	U	305HN.7	2822,99	5,00



EGALIS BASSE TEMPERATURE

Chaudière nue - Avec ballon d'accumulation intégré - Tirage naturel



	DÉSIGNATION	UT	CODE	PPHT (€)	ECOPART (€)
554.3147.74	CHAUD.MUR.CON.EGALIS IC 24/48-1MN 7716701550	U	305J5.2	4201,99	5,00

CHAUDIERE

CHAUDIERE MURALE



MEGALIA BASSE TEMPERATURE

Chaudière nue - Pour chauffage et eau chaude micro-accumulée - Cheminée - Ventouse



	DÉSIGNATION	UT	CODE	PPHT (€)	ECOPART (€)
552.1854.74	CHAUD.MEGALIA COND.AGVAC24-6MN 7716704710	U	8422U.2	2477,99	5,00



MEGALIS BASSE TEMPERATURE

Chaudière nue - Pour chauffage et eau chaude micro-accumulée - Ventouse



	DÉSIGNATION	UT	CODE	PPHT (€)	ECOPART (€)
554.1904.24	CHAUD.MUR.CON.MEGALIS IC 18-25 7716704735	U	314BP.3	2543,99	5,00



HYDROMOTRIX TRADITION VISIO BASSE TEMPERATURE

Chaudière - Pour chauffage et eau chaude micro-accumulée - Cheminée



	DÉSIGNATION	UT	CODE	PPHT (€)	ECOPART (€)
555.2508.97	CHAUD.HYDROMOT.TRADI VISIO23KW MIX. D4AA23230	U	7517V.8	2513,97	5,00



THEMA CLASSIC BAS NOX

Chaudière nue - Pour chauffage et production d'eau chaude micro-accumulée - Cheminée



	DÉSIGNATION	UT	CODE	PPHT (€)	ECOPART (€)
558.1966.00	CHAUD.THEMACLASSIC BAS-NOX C25 0010023630	U	212GT.6	1971,00	5,00



THEMA CLASSIC

Chaudière nue - Pour chauffage et production d'eau chaude micro-accumulée - VMC



	DÉSIGNATION	UT	CODE	PPHT (€)	ECOPART (€)
558.2077.99	CHAUD.THEMACLASSIC V18/24-LC/1 0010023631	U	206V9.8	2082,99	5,00



THEMAPLUS BAS NOX

Chaudière nue - Pour chauffage et production d'eau chaude mini-accumulée + ballon 3L - Cheminée



	DÉSIGNATION	UT	CODE	PPHT (€)	ECOPART (€)
558.2141.99	CHAUD.THEMAPLUS BAS NOX C25 25KW 0010023632	U	214CS.8	2146,99	5,00

Le PPHT comprend l'ecopart (€)

CHAUDIERE

CHAUDIERE MURALE



THEMAPLUS BAS NOX

Chaudière nue - Pour chauffage et production d'eau chaude mini-accumulée + ballon 3L - VMC



	DÉSIGNATION	UT	CODE	PPHT (€)	ECOPART (€)
558.2254.00	CHAUD.THEMAPLUS BAS NOX V25 25KW 0010023633	U	206V0.7	2259,00	5,00

ACCESSOIRES DE CHAUDIERE



KIT VENTOUSE

Kit de base C13 - FC-Set60-C13x



	DÉSIGNATION	UT	CODE	PPHT (€)
504.0109.00	TERMINAL H+COUD.90 FC-SET60-C13X-T 7738113485	U	306QY.1	109,00



MODULE ET KIT HYDRAULIQUE

Kit de montage Cross Matrix



	DÉSIGNATION	UT	CODE	PPHT (€)
504.0171.00	MODULE DE BASE STELLIS ICOND CS 35 7738112830	U	333CY.3	171,00



KIT HYDRAULIQUE

Kit d'équipement



	DÉSIGNATION	UT	CODE	PPHT (€)	ECOPART (€)
515.0572.80	KIT EQUIPEMENT HYDRAULIQUE MY445 7629652	U	6269P.3	716,88	0,88



RACCORDEMENT

Dossieret - Dossieret de montage

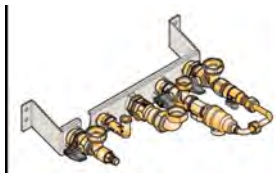

	DÉSIGNATION	UT	CODE	PPHT (€)	ECOPART (€)
553.0220.10	DOSSERET MPX MI COMPACT 7789942	U	350EC.8	220,20	0,10



RACCORDEMENT

Tubulure - Kit tubulures



	DÉSIGNATION	UT	CODE	PPHT (€)	ECOPART (€)
553.0060.00	KIT TUBES RACCORD.MPX MI COMPACT NF 7789928	U	351CN.6	75,88	0,88

Le PPHT comprend l'ecopart (€)

CHAUDIERE

ACCESSOIRES DE CHAUDIERE



RACCORDEMENT

Dossieret - Dossieret d'installation



	DÉSIGNATION	UT	CODE	PPHT (€)
551.0086.10	DOSSERET STD 1ERE INSTAL.DOS GA5 7716780460	U	334VE.6	123,00
551.0119.70	DOSSERET MEGALIS DOSGA5/12 7716780471	U	334VQ.5	171,00



RACCORDEMENT

Dossieret - Dossieret de remplacement



	DÉSIGNATION	UT	CODE	PPHT (€)
551.1077.59	DOSSERET REMPLACEMENT DOSGT5 7716701529	U	334YS.8	1346,99
551.0140.25	DOSSERET DE REMPLACEMENT IDOS GA 6 7716780400	U	3315Z.4	187,00
551.0140.25	DOSSERET REMPLACEMENT IDOS GA 5R 7716780404	U	331A3.2	187,00
551.0149.60	DOSSERET REMPLACEMENT IDOS GS 5R 7716780406	U	342J4.8	187,00
551.0086.10	DOSSERET ACLEIS REMP.ELM DOSGA6 7716780461	U	334VU.6	123,00
551.0086.10	DOSSERET ACLEIS REMP.SAUNIER DOSGA7 7716780462	U	334VX.4	123,00
551.0086.10	DOSSERET CELTIC REMP.MAURY DOSGA8 7716780463	U	334VX.0	123,00
551.0135.10	DOSSERET DE REMPLACEMENT DOSGA17/1 7716780464	U	334VG.2	193,00
551.0196.00	DOSSERET NECTRA ACLEIS DOSGA18 7716780465	U	334W1.4	280,00
551.0086.10	DOSSERET ACLEIS MEGALIS DOSGA5R 7716780466	U	334W5.5	123,00
551.0137.20	DOSSERET REMPL.GLB/GVB DOSGTB7 7716780469	U	334WE.5	196,00



RACCORDEMENT

Dossieret - XDOS



	DÉSIGNATION	UT	CODE	PPHT (€)
974.0086.10	DOSSERET XDOS GA 5 TYPE PREM.INST 7716780578	U	415F4.6	123,00
974.0086.10	DOSSERET XDOS GA 6 REMPLACEMENT 7716780580	U	415F7.9	123,00
974.0086.10	DOSSERET XDOS GA 7 REMPL.SAUNIER 7716780581	U	415FE.3	123,00
974.0086.10	DOSSERET XDOS GA 8 REMPL.CHAFFOT 7716780582	U	415FG.9	123,00
974.0092.25	DOSSERET XDOS GA 15 TYPE PREM.INST 7716780579	U	415F5.3	123,00
974.0092.25	DOSSERET XDOS GA 16 DE REMPL.ELM 7716780595	U	415FB.0	123,00
974.0086.10	DOSSERET XDOS GA 18 REMPL.CHAFFOT. 7716780590	U	415FJ.4	123,00



RACCORDEMENT

Cache tubes magnétique - Pour dossierets oxylys iCONDENS



	DÉSIGNATION	UT	CODE	PPHT (€)
000.0045.00	CACHE TUBES MAGNET.DOSSERET OXYLIS 7716780589	U	416NC.8	60,00

CHAUDIERE

ACCESSOIRES DE CHAUDIERE



KIT DE DOUILLES

Kit de douilles



	DÉSIGNATION	UT	CODE	PPHT (€)
551.0050.00	DOUILLES HW-SETBC 1 7716780444	U	328FB.5	50,00



KIT GAZ

Kit



	DÉSIGNATION	UT	CODE	PPHT (€)
551.0052.00	TRANSFORMATEUR GAZ GVAC 21-5MN B 7716780346	U	5176Q.5	52,00



KIT HYDRAULIQUE

Kit de remplacement - Kit prémonté de remplacement

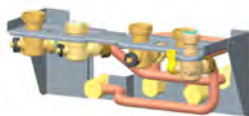

	DÉSIGNATION	UT	CODE	PPHT (€)
558.0121.10	KIT PRE-MONTE REMPL.ELM GLM/GVM 0020201965	U	6247A.8	173,00
558.0173.00	KIT PRE-MONTE REMPL.CELTIC 0020209803	U	7263P.7	173,00
558.0173.00	KIT PRE-MONTE REMPL.ACLEIS 0020202051	U	7301Q.9	173,00
558.0173.00	KIT PRE-MONTE REMPL.NECTRA-ELEXIA 0020209710	U	7240W.0	173,00



RACCORDEMENT

Dosseret/Plaque de raccordement - Plaque de raccordement



	DÉSIGNATION	UT	CODE	PPHT (€)
558.0121.10	PLAQUE RACCORDEMENT THEMA/SEMA 0010040209	U	296W1.5	173,00
558.0182.00	PLAQUE RACCORDEMENT HELIOTWIN CON. 0010040211	U	296W5.6	182,00
558.0152.00	PLAQUE RACCORDEMENT ISOTWIN/ISOMAX 0010040213	U	296W2.3	152,00



RACCORDEMENT

Douille - Douille de remplacement



	DÉSIGNATION	UT	CODE	PPHT (€)
558.0173.00	DOUILLE REMPLAC.ISOFAST/MAX -KIT- 0020106137	U	9635J.4	173,00
558.0015.40	DOUILLE REMPLAC.LONGUE SD -KIT- A2022500	U	5217K.6	22,00
559.0015.40	DOUILLE REMPLAC.COURTE SD -KIT- 0020210110	U	6830S.7	22,00
558.0016.50	DOUILLES LONGUES 70MM 0010025500	U	217BM.2	22,00

CHAUDIERE

ACCESSOIRES DE CHAUDIERE



RACCORDEMENT

Cache tubulure / Tubulure - Tubulure express

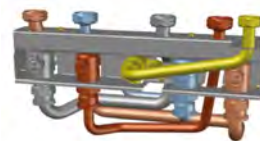

	DÉSIGNATION	UT	CODE	PPHT (€)
558.0129.75	TUBULURE REMPLACEMENT ACLEIS+CACHE 0010025502	U	216NE.7	173,00
558.0129.75	TUBULURE REMPLACEMENT GLM+CACHE 0010025503	U	216NG.3	173,00
558.0129.75	TUBULURE REMPLACEMENT NECTRA+CACHE 0010025505	U	216NJ.8	173,00
558.0129.75	TUBULURE EXPRESS REMPL SAUNIER D. 0010025501	U	213TQ.3	173,00



RACCORDEMENT

Cadre écarteur



	DÉSIGNATION	UT	CODE	PPHT (€)
558.0015.40	CADRE ECARTEUR REMP.THEMA COND. SD 0020082851	U	52182.3	22,00
559.0034.30	CADRE ECARTEUR THEMACLASSIC A2002900	U	7055R.5	49,00
558.0036.75	CADRE ECARTEUR 70M PREMONTE 0010025506	U	216NC.2	49,00



POMPE DE RELEVAGE DES CONDENSATS

SaniCondens Eco - 220-240 - 50 Hz



	DÉSIGNATION	UT	CODE	PPHT (€)	ECOPART (€)
717.0094.24	POMPE RELEV.SANICONDENS ECO CHAUD. SK&ECO	U	293TD.9	118,05	0,25

Pour plus d'infos,
consultez
le CAHIER TECHNIQUE
page 14

Le PPHT comprend l'ecopart (€)

ACCESSOIRES DE CHAUFFAGE

EQUILIBRAGE



EQUILIBRAGE MANUEL

Vanne d'équilibrage taraudée à fonction multiples - STAD : Mesure, isolement, vidange, réglage



	DÉSIGNATION	UT	CODE	PPHT (€)
652.0098.56	VANNE EQUILIBRAGE MULTIF.STAD20 52851120	U	180RV.5	131,42
652.0115.20	VANNE EQUILIBRAGE MULTIF.STAD25 DN25 52851125	U	180RW.3	153,60
652.0142.24	VANNE EQUILIBRAGE MULTIF.STAD32 52851132	U	180RY.9	189,65

EXPANSION



AUTRES ACCESSOIRES

Vidage Flexcon Drain Tub



	DÉSIGNATION	UT	CODE	PPHT (€)
650.0034.80	VIDAGE EN PT BAS FLEXCON DRAIN TUB 27958	U	7955W.5	34,80



EXCLUSIVITES RICHARDSON PAR GITRAL

Vase expansion chauffage



	DÉSIGNATION	UT	CODE	PPHT (€)
000.0034.86	VASE EXPANSION CHAUF. 12L TEKNIK 130G001210	U	312Q0.8	49,80
000.0033.43	VASE EXPANSION CHAUF. 18L TEKNIK 130G001812	U	312Q1.6	47,75
000.0040.53	VASE EXPANSION CHAUF. 25L TEKNIK 130G002511	U	312Q2.4	57,90
000.0072.66	VASE EXPANSION CHAUF. 35L TEKNIK 130G003515	U	312Q3.2	103,80



EXCLUSIVITES RICHARDSON PAR GITRAL

Accessoires de chauffage - Kit d'installation



	DÉSIGNATION	UT	CODE	PPHT (€)
000.0026.11	KIT D'INSTAL.VASES SANITAIRES TEKNIK 912545	U	312Q6.5	37,30



VASE D'EXPANSION FERME A MEMBRANE

Cylindrique - Standard



	DÉSIGNATION	UT	CODE	PPHT (€)	ECOPART (€)
653.0050.10	VASE D'EXPANSION FERME A MEMBRANE 8L V008	U	56955.8	66,80	

Le PPHT comprend l'ecopart (€)

ACCESSOIRES DE CHAUFFAGE

EXPANSION



VASE D'EXPANSION FERME A MEMBRANE

Cylindrique - Standard
- suite



	DÉSIGNATION	UT	CODE	PPHT (€)	ECOPART (€)
653.0048.08	VASE D'EXPANSION FERME A MEMBRANE 12L V012	U	56969.9	64,10	
653.0045.38	VASE D'EXPANSION FERME A MEMBRANE 18L V018	U	43981.0	60,50	
653.0055.72	VASE D'EXPANSION FERME A MEMBRANE 25L V025	U	44074.3	74,30	
653.0099.75	VASE D'EXPANSION FERME A MEMBRANE 35L V035	U	44185.7	133,01	0,01
653.0135.75	VASE D'EXPANSION FERME A MEMBRANE 50L V050	U	44226.9	181,01	0,01
653.0234.75	VASE D'EXPANSION FERME A MEMBRANE 80L V080	U	44271.5	313,01	0,01



ACCESSOIRES DE VASE D'EXPANSION

Potence pour support mural de vase jusqu'au 25 litres - ZSM



	DÉSIGNATION	UT	CODE	PPHT (€)
653.0041.70	POTENCE P.SUPPORT MURAL DE VASE ZSM	U	07858.4	55,60



ACCESSOIRES DE VASE D'EXPANSION

Potence équipée d'accessoires montés - ZSMC



	DÉSIGNATION	UT	CODE	PPHT (€)
653.0104.25	POTENCE EQUIPEE AV.ACCESSOIRES MONTES ZSMC	U	54229.0	139,00



ACCESSOIRES DE VASE D'EXPANSION

Raccord rapide - ZR558 - Sans purgeur



	DÉSIGNATION	UT	CODE	PPHT (€)
653.0028.50	RACCORD RAPIDE 3/4 P.VASE EXP. 558500 ZR558	U	50083.5	38,00



ACCESSOIRES DE VASE D'EXPANSION

Equerre de fixation - ZSEQ



	DÉSIGNATION	UT	CODE	PPHT (€)
653.0021.45	EQUERRE P.VASE EXPANSION TAR.3/4 ZSEQ	U	6309L.1	28,60

ACCESSOIRES DE CHAUFFAGE

SECURITE



CLAPET ISOLANT POUR VASE D'EXPANSION

Clapet isolant - vase expansion - Laiton



	DÉSIGNATION	UT	CODE	PPHT (€)
000.0034.16	CLAPET ISOL.SS PURGE 3/4" MF TEKNIK 910199	U	317RJ.6	48,80



SOUPAPE DE SURETE

Soupape différentielle - Température maxi : 110C°
- Pression maxi : 10 bar



	DÉSIGNATION	UT	CODE	PPHT (€)
653.0043.82	SOUPAPE DIFFERENTIELLE 3/4 FM SD20	U	12721.7	62,60



SOUPAPE DE SURETE

Soupape avec manomètre



	DÉSIGNATION	UT	CODE	PPHT (€)
653.0013.56	SOUPAPE SURETE+MANOMETRE 3B 1/2ZM S15ZM	U	29883.6	22,60



SOUPAPE DE SURETE

Soupape sans manomètre - Corps laiton



	DÉSIGNATION	UT	CODE	PPHT (€)
653.0011.46	SOUPAPE SURETE S.MANOMETRE 3B1/2F 311431 S15Z	U	29916.4	19,10



SOUPAPE DE SURETE

Soupape sans manomètre - Série G - Corps bronze



	DÉSIGNATION	UT	CODE	PPHT (€)
653.0046.80	SOUPAPE SURETE S.MANOMETRE 4B 3/4G S20G4	U	07409.6	58,50



SOUPAPE DE SURETE

Sanitaire



	DÉSIGNATION	UT	CODE	PPHT (€)	ECOPART (€)
430.0030.20	SOUPAPE SANITAIRE MSL70 MF1/2 7B 0206070N	U	281SB.9	40,28	0,01

ACCESSOIRES DE CHAUFFAGE

SECURITE



SOUPAPE DE SURETE

Sanitaire sortie majorée



	DÉSIGNATION	UT	CODE	PPHT (€)	ECOPART (€)
430.0049.16	SOUPAPE SVW 100 F3/4-F1' 10B 0217099N	U	3940S.0	65,55	0,01
430.0039.87	SOUPAPE SANIT.SVW70-F1/2'-F3'/4 10B 0216099N	U	331F3.7	53,17	0,01

MESURE



THERMOMETRE

Industriel en verre - Droit



	DÉSIGNATION	UT	CODE	PPHT (€)
650.0015.62	THERMOMETRE INDUST.DROIT L63 -30/50 58DLIM03D	U	44619.5	20,82
650.0015.62	THERMOMETRE INDUST.DROIT L63 0/120C 74DLIM03D	U	44733.4	20,82



THERMOMETRE

Industriel en verre - Equerre



	DÉSIGNATION	UT	CODE	PPHT (€)
650.0015.95	THERMOMETRE INDUST.EQ.L63 -30/50C 58ELIM03D	U	44613.8	21,27
650.0015.95	THERMOMETRE INDUST.EQ.L63 0/120C 74ELIM03D	U	44731.8	21,27



THERMOMETRE

Bimétallique à cadran - Applique - Ø 63 - 80



	DÉSIGNATION	UT	CODE	PPHT (€)
430.0010.15	THERMOMETRE BIMETAL APPLIQUE 0-120 D63 74503	U	83556.1	13,53



THERMOMETRE

Doigt de gant - Inox



	DÉSIGNATION	UT	CODE	PPHT (€)
430.0008.80	DOIGT DE GANT A45 LAIT.L100 FIL.1/2 GLA45304D	U	5916U.1	11,73

Le PPHT comprend l'ecopart (€)

ACCESSOIRES DE CHAUFFAGE

MESURE



THERMOMETRE

Doigt de gant - Laiton



DÉSIGNATION	UT	CODE	PPHT (€)
430.0013.24 DOIGT DE GANT LAITON FIL.1/2	U	67269.1	17,65



THERMOMETRE

A plongeur - Axial



DÉSIGNATION	UT	CODE	PPHT (€)	ECOPART (€)
653.0012.45 THERMOMETRE PLONG.AXIAL 80 0/120 T080A	U	72022.7	16,62	0,02

ACCESSOIRES DE CHAUFFERIE



BOUEILLE DE MELANGE

Pose murale - Jaquette skaï bleu - Chauffage et Climatisation - 8 piquages



DÉSIGNATION	UT	CODE	PPHT (€)	ECOPART (€)
653.0357.75 BOUEILLE MELANG.MUR.SKAÏ 25L 2X4P BMEL25SK	U	91829.2	477,01	0,01
653.0433.50 BOUEILLE MELANG.MUR.SKAÏ 50L 2X4P BMEL50SK	U	2729A.4	578,02	0,02



BOUEILLE DE MELANGE

Pose au sol - Jaquette skaï bleu - Chauffage



DÉSIGNATION	UT	CODE	PPHT (€)	ECOPART (€)
653.0537.75 BOUEILLE MELANG.SOL SKAÏ 100L 2X4P BMEL100SK	U	0161L.1	717,02	0,02
653.0689.25 BOUEILLE MELANG.SOL SKAÏ 200L 2X4P BMEL200SK	U	01620.4	919,04	0,04



ALIMENTATION ET VIDANGE DE CHAUDIERE

Alimentateur automatique



DÉSIGNATION	UT	CODE	PPHT (€)
653.0096.75 ALIMENTATEUR AUTOMATIQUE 15X21 553140 ABTM	U	46583.1	129,00

ACCESSOIRES DE CHAUFFAGE

ACCESSOIRES DE CHAUFFERIE



PURGEUR D'AIR AUTOMATIQUE

Standard - R2 - Avec clapet de démontage



DÉSIGNATION	UT	CODE	PPHT (€)
653.0010.65 PURGEUR D'AIR AUTO.+CLAPET 3/8 PR2	U	07632.3	14,20



PURGEUR D'AIR AUTOMATIQUE

Standard - VENCAL - Chromé sans clapet



DÉSIGNATION	UT	CODE	PPHT (€)
653.0023.20 PURGEUR D'AIR AUTO.VENCAL 1/2 PVENC15	U	92073.6	23,20



PURGEUR D'AIR AUTOMATIQUE

Standard - DISCALAIR



DÉSIGNATION	UT	CODE	PPHT (€)
653.0051.12 PURGEUR D'AIR DISCAL AIR F1/2" 10BAR P51	U	5717U.2	85,20



PURGEUR D'AIR AUTOMATIQUE

Compact



DÉSIGNATION	UT	CODE	PPHT (€)
653.0009.75 PURGEUR D'AIR AUTO.A FLOTTEUR ROBOCAL 3/8 PR	U	79173.1	13,00



PURGEUR D'AIR AUTOMATIQUE

Ventstream



DÉSIGNATION	UT	CODE	PPHT (€)
653.0025.35 PURGEUR D'AIR VENSTREAM 1/2 PVENT15	U	17827.7	33,80



CLAPET ANTITHERMOSIPHON - VANNE DEPART/RETOUR

Clapet universel CAL - A sortie droite ou équerre



DÉSIGNATION	UT	CODE	PPHT (€)
653.0046.50 CLAPET CAL UNIV.1" 510600 CCAL26	U	31725.5	62,00
653.0083.50 CLAPET CAL UNIV.11/4 CCAL33	U	31726.3	83,50

Le PPHT comprend l'ecopart (€)

ACCESSOIRES DE CHAUFFAGE

ACCESSOIRES DE CHAUFFERIE



DEGAZAGE - DECANTATION

Dirtmag Orientable - Pot de décantation - Corps en polymère - Té en laiton



	DÉSIGNATION	UT	CODE	PPHT (€)	ECOPART (€)
653.0153.00	POT DECANTAT.OR.DIRTMAG 3/4" 545305 PD54520	U	16612.4	153,00	
653.0135.20	POT DECANTAT.OR.DIRTMAG 1" 545306 PD54526	U	16647.0	169,00	



DEGAZAGE - DECANTATION

Dirtcal - Pot de décantation - Corps laiton



	DÉSIGNATION	UT	CODE	PPHT (€)	ECOPART (€)
653.0147.75	POT DE DECANTATION DIRTCAL 1" 546206 PD54626	U	04698.7	197,01	0,01



DEGAZAGE - DECANTATION

Pot de décantation - Pour installation domestique - Corps Acier



	DÉSIGNATION	UT	CODE	PPHT (€)	ECOPART (€)
653.0153.60	POT DE DECANTATION 1" 4L PID05	U	1799C.7	192,01	0,01

ACCESSOIRES FIOUL



COLIMAZOUT

Kit complet - Colimazout



	DÉSIGNATION	UT	CODE	PPHT (€)	ECOPART (€)
650.0154.07	COLIMAZOUT CMV2 22L0146302	U	50636.0	205,44	0,01



COLIMAZOUT

Canne d'aspiration - Combiné multibloc bitube



	DÉSIGNATION	UT	CODE	PPHT (€)	ECOPART (€)
650.0071.38	COMBINE MULTIBLOC BITUBE MBS220R 22L0108204	U	50639.4	95,19	0,01

ACCESSOIRES DE CHAUFFAGE

ACCESSOIRES FIOUL



FILTRE ET RECYCLAGE

Filtre bitube - Laiton - 2 tuyaux



	DÉSIGNATION	UT	CODE	PPHT (€)	ECOPART (€)
650.0062.08	FILTRE BITUBE RV2 22L0133100	U	52046.0	82,78	0,01



FILTRE ET RECYCLAGE

Filtre à recyclage - Laiton - 1 tuyau



	DÉSIGNATION	UT	CODE	PPHT (€)	ECOPART (€)
650.0081.34	FILTRE A RECYCLAGE RZ 22L0137100	U	50631.1	108,46	0,01



JAUGE ET ACCESSOIRES

Jauge pneumatique Televar



	DÉSIGNATION	UT	CODE	PPHT (€)	ECOPART (€)
650.0124.78	JAUGE PNEUMATIQUE TELEVAR TLM3 22L0101103	U	50640.2	166,39	0,01



JAUGE ET ACCESSOIRES

Jauge mécanique - Vertical



	DÉSIGNATION	UT	CODE	PPHT (€)	ECOPART (€)
650.0031.16	JAUGE MECANIQUE VERT.MECA-M 200V 22L0103102	U	42351.7	41,56	0,01

TRAITEMENT DES EAUX DE CHAUFFAGE



BEST WATER TECHNOLOGY

SOLUTECH

Traitement des circuits fermés - SoluTECH
Protection intégrale



	DÉSIGNATION	UT	CODE	PPHT (€)	ECOPART (€)
654.0039.00	PROTECTION INTEGR.SOLUTECH -500ML- 125299983	U	300FV.5	52,00	

Le PPHT comprend l'ecopart (€)

ACCESSOIRES DE CHAUFFAGE

TRAITEMENT DES EAUX DE CHAUFFAGE



Traitement des circuits fermés - SoluTECH Anti-Fuite



DÉSIGNATION	UT	CODE	PPHT (€)
654.0039.00 ANTIFUITE SOLUTECH BID.500ML C0007471A	U	10261.9	52,00



Traitement des circuits fermés - SoluTECH lessivage et désembouage



DÉSIGNATION	UT	CODE	PPHT (€)
654.0039.00 NETTOYANT DESEMB.SOLUTECH -500ML- 125299985	U	300FT.0	52,00



FILTRE MAGNETIQUE
MGF - Chaudières murales



DÉSIGNATION	UT	CODE	PPHT (€)
660.0089.82 FILTRE MAGNETIQUE MGF 3/4" NOIR RBM 37010550	U	235CQ.7	119,76



FILTRE MAGNETIQUE
SAFECLEANER - Multiposition - Avec pot à boue et sas d'injection



DÉSIGNATION	UT	CODE	PPHT (€)
660.0147.32 FILTRE MAGNETIQUE SAFE-CLEANER 3/4" 23440550	U	0855J.6	196,43
660.0162.43 FILTRE MAGNETIQUE SAFE-CLEANER 1" 23440650	U	0855T.8	216,57



FILTRE NEUTRALISEUR CONDENSATS
NT1 - Super compact



DÉSIGNATION	UT	CODE	PPHT (€)
660.0066.03 FILTRE NEUTRALISANT NT1 D16/20 32860530	U	164R3.6	77,68

Le PPHT comprend l'ecopart (€)

ACCESSOIRES DE CHAUFFAGE

TRAITEMENT DES EAUX DE CHAUFFAGE



FILTRE
Eliminator Vortex - Magnétique - Vortex500



DÉSIGNATION	UT	CODE	PPHT (€)	ECOPART (€)
000.0140.39 FILTRE VORTEX 500 1" ELIMV500-GRP1M-EXP	U	246XL.7	215,99	0,01



FILTRE
Eliminator Vortex - Magnétique - Vortex300



DÉSIGNATION	UT	CODE	PPHT (€)	ECOPART (€)
000.0157.49 FILTRE VORTEX 300 3/4 ELIMV300-GRP3/4M-EXP	U	246XL.9	157,50	0,01



ADDITIF
Produit formulé - X100 Inhibiteur de corrosion



DÉSIGNATION	UT	CODE	PPHT (€)
654.0814.18 INHIBITEUR X100 -JERR.20L- X100L-20L-EXP	U	229WF.5	1085,57
654.0053.41 INHIBITEUR MULTIMET/MULTIRES X100L-12X1L-EXPB	U	299AZ.7	71,21
654.0056.96 INHIBITEUR X100 -300ML- X100RD-12X300ML-EXP	U	304SB.9	75,95



ADDITIF
Produit formulé - X400 Désembouant



DÉSIGNATION	UT	CODE	PPHT (€)
654.0732.76 DESEMBOUANT X400-CUB.20L- X400L-20L-FR	U	49022.7	977,01



ADDITIF
Produit formulé - X800 Désembouant rapide



DÉSIGNATION	UT	CODE	PPHT (€)
654.0803.42 DESEMBOUANT X800-CUB.20L X800L-20L-EXP	U	241J0.0	1071,23
654.0052.30 DESEMBOUANT RAP.X800 1L X800L-12X1L-EXPB	U	299B0.6	69,73

Pour plus d'infos,
consultez
le CAHIER TECHNIQUE
page 14

BRULEUR

BRULEUR FIOUL - PETITE PUISSANCE



NC4-NC6-NC9
Brûleur Fioul



	DÉSIGNATION	UT	CODE	PPHT (€)	ECOPART (€)
612.0897.75	BRULEUR FUEL NC4 0.6 H101A T1CUENOD.3832014	U	2104L.7	1198,67	1,67

ACCESSOIRES DE BRULEUR



FLEXIBLE

Flexible droit - Par 2



	DÉSIGNATION	UT	CODE	PPHT (€)
650.0030.24	FLEXIBLE DROIT P.BRULEUR+RACCORD -LOT- 909904	U	5111D.7	40,32



FLEXIBLE

Flexible coudé - Lot



	DÉSIGNATION	UT	CODE	PPHT (€)
650.0031.64	FLEXIBLE COUDE P.BRULEUR+RACCORD -LOT- 909905	U	5111E.4	42,18



THERMOCOUPLE



	DÉSIGNATION	UT	CODE	PPHT (€)
500.0013.28	THERMOCOUPLE UNIVERSEL DIFF 704211	U	7250Z.8	13,28

CIRCULATEUR

CIRCULATEUR DOMESTIQUE

wilo

STRATOS PICO

Circulateur à Haut rendement avec raccord fileté et adaptation automatique de la Puissance



	DÉSIGNATION	UT	CODE	PPHT (€)
633.0305.00	CIRCULATEUR STRATOS PICO 25/1-4 ROW 4216612	U	165M7.3	305,00
633.0352.00	CIRCULATEUR STRATOS PICO 25/1-6 ROW 4216613	U	183EZ.9	352,00

CIRCULATEUR PETIT COLLECTIF ET COLLECTIF

wilo

YONOS PICO - CIRCULATEUR COLLECTIF HAUT RENDEMENT

Yonos PICO - Pompe simple à haut rendement



	DÉSIGNATION	UT	CODE	PPHT (€)	ECOPART (€)
633.0373.00	CIRCULATEUR YONOS PICO 15/1-4 ROW 4215511	U	9415X.3	373,01	0,01
633.0239.25	CIRCULATEUR YONOS PICO 25/1-4 ROW 180 4215513	U	94169.0	319,01	0,01
633.0266.25	CIRCULATEUR YONOS PICO 25/1-4-130 ROW 4215514	U	9416P.9	355,01	0,01
633.0274.50	CIRCULATEUR YONOS PICO 25/1-6 ROW 4215515	U	9416S.3	366,01	0,01
633.0414.00	CIRCULATEUR YONOS PICO 25/1-8 ROW 4215517	U	9416X.2	552,01	0,01
633.0293.25	CIRCULATEUR YONOS PICO 30/1-4 ROW 4215519	U	94174.0	391,01	0,01
633.0336.75	CIRCULATEUR YONOS PICO 30/1-6 ROW 4215520	U	94177.3	449,01	0,01
633.0495.75	CIRCULATEUR YONOS PICO 30/1-8 ROW 4215521	U	94178.1	661,01	0,01

CIRCULATEUR BOUCLAGE ECS

thermador

ACCESSOIRES

Pour circulateur ECS



	DÉSIGNATION	UT	CODE	PPHT (€)
653.0022.47	RACCORD UNION A VISSER F 1 ZRUL26	U	6099F.6	32,10

wilo

STAR - Z (CIRCOSTAR)

Wilo - Star - Z - RP 1/2



	DÉSIGNATION	UT	CODE	PPHT (€)	ECOPART (€)
633.0421.50	CIRCULATEUR WILO STAR Z20/1 140 MONO 4028111	U	45778.8	562,01	0,01

Le PPHT comprend l'ecopart (€)

CIRCULATEUR

CIRCULATEUR BOUCLAGE ECS

wilo

STAR - Z (CIRCOSTAR)
Wilo - Star - Z - RP 1



	DÉSIGNATION	UT	CODE	PPHT (€)	ECOPART (€)
633.0503.25	CIRCULATEUR WILO STAR Z25/2 180 MONO 4029062	U	55990.6	671,01	0,01

wilo

STAR - Z NOVA
Nova



	DÉSIGNATION	UT	CODE	PPHT (€)	ECOPART (€)
633.0189.00	CIRCULATEUR WILO STAR Z NOVA MONO 4132760	U	52640.2	252,01	0,01

wilo

STAR - Z NOVA
Nova T



	DÉSIGNATION	UT	CODE	PPHT (€)	ECOPART (€)
633.0373.50	CIRCULATEUR STAR Z NOVA T 4222650	U	19876.0	498,01	0,01

wilo

ACCESSOIRES
Raccord-union en Laiton



	DÉSIGNATION	UT	CODE	PPHT (€)	ECOPART (€)
633.0024.18	RACCORD UNION R1/2A15XG11 215/20-JEU-4092743	U	54284.5	32,25	0,01

ACCESSOIRES DE CIRCULATEUR

wilo

ACCESSOIRES RACCORDEMENT
Pochette



	DÉSIGNATION	UT	CODE	PPHT (€)	ECOPART (€)
633.0018.35	RACCORD UNION 4049-2634-G1 1/2-G1 4092741	U	8454N.6	24,48	0,01
633.0036.02	RACCORD UNION 5060-3342-G2 G1 1/4 4092742	U	78415.7	36,03	0,01

Le PPHT comprend l'ecopart (€)

REGULATION

REGULATION ELECTRONIQUE ET MECANIQUE

atlantic

BRIDGE COZYTOUCH

Solution connectée pour le confort thermique - Wifi



	DÉSIGNATION	UT	CODE	PPHT (€)	ECOPART (€)
673.0112.00	BRIDGE COZYTOUCH WIFI 500109	U	324NA.8	112,12	0,12

atlantic

COMMANDE D'AMBIANCE MODULANTE

Navilink - A



	DÉSIGNATION	UT	CODE	PPHT (€)	ECOPART (€)
501.0124.80	COMMANDE AMBIANCE MODULANTE A59B 074231	U	220J3.8	156,12	0,12

BOSCH

REGULATION CONNECTEE

EasyControl



	DÉSIGNATION	UT	CODE	PPHT (€)	ECOPART (€)
551.0405.00	REGULATION EASYCONTROL CT200 BLC 7736701341	U	196A0.5	405,12	0,12

De Dietrich

COMMANDE A DISTANCE

Commande à distance



	DÉSIGNATION	UT	CODE	PPHT (€)	ECOPART (€)
553.0250.50	COMMANDE DIST.RADIO MOD.CDR4 AD284 100018923	U	1237E.2	334,12	0,12

De Dietrich

MODULE CHAUDIERE RADIO

Module radio



	DÉSIGNATION	UT	CODE	PPHT (€)	ECOPART (€)
553.0131.25	MODULE RADIO DIEMATIC AD252 100013307	U	4036J.0	175,12	0,12

De Dietrich

SONDE

Sonde ECS



	DÉSIGNATION	UT	CODE	PPHT (€)	ECOPART (€)
553.0059.60	SONDE ECS OPTION AD212 100000030	U	5651A.9	74,52	0,02

REGULATION

REGULATION ELECTRONIQUE ET MECANIQUE

De Dietrich

SONDE

Sonde de départ



	DÉSIGNATION	UT	CODE	PPHT (€)	ECOPART (€)
553.0096.80	SONDE DEPART V3V AD199 88017017	U	52702.8	121,02	0,02

De Dietrich

THERMOSTAT D'AMBIANCE

Thermostat d'ambiance programmable - Filaire



	DÉSIGNATION	UT	CODE	PPHT (€)	ECOPART (€)
553.0100.50	THERMOSTAT AMB.PROG.FILAIRE AD337 7768817	U	310VX.0	134,12	0,12

De Dietrich

THERMOSTAT D'AMBIANCE

Thermostat d'ambiance programmable - Sans fil



	DÉSIGNATION	UT	CODE	PPHT (€)	ECOPART (€)
553.0243.00	THERMOSTAT AMB.PROG.RADIO AD338 7768818	U	310VY.8	324,12	0,12

De Dietrich

THERMOSTAT D'AMBIANCE

Thermostat d'ambiance connecté - SMART TC°



	DÉSIGNATION	UT	CODE	PPHT (€)	ECOPART (€)
505.0383.20	THERMOSTAT AMB.CONNECTE RADIO AD341 7691377	U	294ZS.3	479,12	0,12

De Dietrich

THERMOSTAT D'AMBIANCE

Thermostat d'ambiance modulant - Filaire



	DÉSIGNATION	UT	CODE	PPHT (€)	ECOPART (€)
553.0218.25	THERMOSTAT AMB.MODULANT FILAIRE AD304 7609763	U	5313A.9	291,12	0,12

De Dietrich

THERMOSTAT D'AMBIANCE

Thermostat d'ambiance modulant - Sans fil



	DÉSIGNATION	UT	CODE	PPHT (€)	ECOPART (€)
553.0382.40	THERMOSTAT AMB.MODULANT RADIO AD303 7609762	U	3104Y.0	478,12	0,12

REGULATION

REGULATION ELECTRONIQUE ET MECANIQUE

elm.leblanc

REGULATION MURALE

Gamme CR/CW



	DÉSIGNATION	UT	CODE	PPHT (€)	ECOPART (€)
551.0190.00	REGULATEUR A SONDE EXT.PROG.CW100 7738111039	U	6850B.4	190,12	0,12
551.0107.20	REGULATEUR AMB.PROG.CR100 7738111048	U	7655S.7	134,12	0,12

elm.leblanc

REGULATION MURALE

KCR



	DÉSIGNATION	UT	CODE	PPHT (€)	ECOPART (€)
504.0198.00	REGULATION SANS FIL CE KCR 110RF 7738112339	U	278E4.9	264,12	0,12

elm.leblanc

THERMOSTAT D'AMBIANCE



	DÉSIGNATION	UT	CODE	PPHT (€)	ECOPART (€)
551.0100.80	THERMOSTAT HEBDOMADAIRE TRL7.26 7716780149	U	1376B.0	144,12	0,12
551.0098.00	THERMOSTAT HEBDOMADAIRE TRL7.26AF 7716780156	U	2755A.1	140,12	0,12
551.0116.90	THERMOSTAT HEBDOMADAIRE TRL7.26RF 7716780150	U	2815A.9	167,12	0,12
551.0181.50	REGULATION SANS FIL NSC RF 7716780374	U	10380.2	242,12	0,12

ESBE

VANNE ROTATIVE

Série VRG130 - Vanne de mélange - VRG131 - Filetage intérieur



	DÉSIGNATION	UT	CODE	PPHT (€)
680.0082.45	VANNE MELANGE VRG131 20-6.3 RP 3/4 11600900	U	9245A.4	97,00
680.0086.70	VANNE MELANGE VRG131 25-10 RP 1 11601100	U	9248A.1	102,00

ESBE

VANNE ROTATIVE

Série VRG140 - Vanne de mélange - VRG141 - Filetage intérieur



	DÉSIGNATION	UT	CODE	PPHT (€)
680.0093.50	VANNE MEL.4V VRG141 DN20 6.3 RP3/4 11640300	U	9254A.2	110,00
680.0100.30	VANNE MEL.4V VRG141 DN25 10 RP1" 11640400	U	9257A.9	118,00

Le PPHT comprend l'ecopart (€)

REGULATION

REGULATION ELECTRONIQUE ET MECANIQUE



MULTI IN HYDRONOMIC SYSTEM CONTROL

VANNE THERMOSTATIQUE

Série VTA320 - VTA322 - Filetage extérieur



	DÉSIGNATION	UT	CODE	PPHT (€)
680.0096.90	VANNE THERMOSTAT. 35-60 ECS VTA 322 31100600	U	99618.1	114,00



MULTI IN HYDRONOMIC SYSTEM CONTROL

SERVOMOTEUR ROTATIF

Série ARA600 - 3 points - Mélange, 230 V AC



	DÉSIGNATION	UT	CODE	PPHT (€)
680.0204.00	SERVOMOTEUR ARA661 3PTS 230V AC 6NM 12101300	U	09356.5	240,00



MULTI IN HYDRONOMIC SYSTEM CONTROL

THERMOSTAT DE GAZ DE FUMEE

Thermostat de sécurité - Pour plancher chauffant - Réarmement manuel



	DÉSIGNATION	UT	CODE	PPHT (€)
680.0035.25	THERMOSTAT SECU.TSA121 40-70C MANUEL 86900100	U	168N7.6	47,00

Honeywell Home

THERMOSTAT D'AMBIANCE

Thermostat simple - Mural



	DÉSIGNATION	UT	CODE	PPHT (€)	ECOPART (€)
680.0027.29	THERMOSTAT AMBIANCE CONTACT INV. T6360A1004	U	71349.5	34,13	0,02

Honeywell Home

THERMOSTAT D'AMBIANCE

Thermostat simple - Filaire digital non programmable



	DÉSIGNATION	UT	CODE	PPHT (€)	ECOPART (€)
680.0067.39	THERMOSTAT AMBIANCE DIGITAL FIL. DT90A1008	U	6409E.3	67,39	

Honeywell Home

THERMOSTAT D'AMBIANCE

Thermostat d'ambiance programmable - Programmable filaire T4



	DÉSIGNATION	UT	CODE	PPHT (€)	ECOPART (€)
680.0139.24	THERMOSTAT FILAIRE PROG. T4 HEBDO T4H110A1023	U	57605.8	185,67	0,02

Le PPHT comprend l'ecopart (€)

REGULATION

REGULATION ELECTRONIQUE ET MECANIQUE

Honeywell Home

THERMOSTAT D'AMBIANCE

Thermostat d'ambiance programmable - Programmable sans fil T4R



	DÉSIGNATION	UT	CODE	PPHT (€)	ECOPART (€)
680.0212.14	THERMOSTAT SS FIL PROG. T4R Y4H910RF4004	U	5760T.1	282,88	0,02

Saunier Duval

Toujours à vos côtés.

PROGRAMMATEUR ET THERMOSTAT D'AMBIANCE



	DÉSIGNATION	UT	CODE	PPHT (€)	ECOPART (€)
680.0287.20	COMMANDE DEPART. MIPRO SENSE RADIO 0020260988	U	2825Z.9	359,12	0,12
680.0359.00	REGULATEUR MODUL.EXACONTROL E7R BB 0020049691	U	5579F.7	359,12	0,12
680.0159.00	REGULATEUR MODUL.EXACONTROL E7 C 0020118071	U	12626.8	159,12	0,12
680.0306.75	REGULATEUR MODUL.EXACONTROL E7R CB 0020118072	U	9269G.2	409,12	0,12
680.0399.00	EXTENSION GESTION MULTIZONE L11 0020188586	U	9245P.6	399,42	0,42
680.0156.00	MODULE EXTENSION RED-3 0020257508	U	186WH.3	208,12	0,12
680.0224.00	MODULE EXTENSION RED-5 0020257510	U	2824Z.0	280,12	0,12
680.0539.00	MODULE HYDRAULIQUE HYBR.SD L10 0020188585	U	9245N.8	539,42	0,42
680.0071.20	REGULATEUR MODUL.EXACONTROL SELECT 0010041872	U	355V1.0	89,12	0,12

Saunier Duval

Toujours à vos côtés.

REGULATEUR D'AMBIANCE

Régulateur d'ambiance modulante - Traducteur - Gestion - Régulation



	DÉSIGNATION	UT	CODE	PPHT (€)	ECOPART (€)
782.0356.25	MIPRO SENSE R 0020260979	U	275Y9.0	475,12	0,12
680.0201.00	REGUL FIL. MIPRO SENSE + SDE .EXT 0020260971	U	297T7.3	268,12	0,12
680.0211.20	MIPRO SENSE REMOTE 0020260982	U	298PB.6	264,12	0,12
680.0381.00	MISET RADIO 0020261007	U	3112B.7	381,12	0,12
680.0177.00	MISET 0020260994	U	283UY.8	177,12	0,12

Saunier Duval

Toujours à vos côtés.

SONDE EXTERIEURE



	DÉSIGNATION	UT	CODE	PPHT (€)	ECOPART (€)
680.0143.00	SONDE EXTERIEURE 0020082651	U	215NW.5	143,02	0,02
680.0020.00	SONDE SANITAIRE BALLON/CHAUFFAGE 0020004238	U	298PM.4	20,02	0,02

CONDUIT DE FUMÉE

CHEMINÉE



PGI POUR POELE A PELLETS ET FOYER GAZ ETANCHE

Embase - Pour terminal vertical



	DÉSIGNATION	UT	CODE	PPHT (€)
658.0053.77	SOLIN TUILE 15-30 80-130 PGI 37080786/311	U	1784E.9	71,69



CONDUIT RIGIDE ALUMINIE

Pour appareil au fioul, bois et charbon au conduit de fumée. - Manchette



	DÉSIGNATION	UT	CODE	PPHT (€)
655.0005.49	MANCHETTE GALVA 97 147970	U	6633A.0	7,85
655.0005.56	MANCHETTE GALVA 111 147111	U	6634A.9	7,94
655.0005.98	MANCHETTE GALVA 125 147125	U	6631A.2	8,54
655.0008.67	MANCHETTE GALVA 153 147153	U	6635A.8	12,38



CONDUIT RIGIDE ALUMINIE

Pour appareil au fioul, bois et charbon au conduit de fumée. - Chapeau chinois extensible



	DÉSIGNATION	UT	CODE	PPHT (€)
655.0028.07	CHAPEAU CHINOIS GALVA 83A111 570001	U	6424A.3	40,10
655.0030.91	CHAPEAU CHINOIS GALVA 125A139 570002	U	6421A.6	44,16



CONDUIT RIGIDE ALUMINIUM

Raccordement hotte de cuisine, sèche-linge et chauffe-eau. Ventilation. - Tuyau



	DÉSIGNATION	UT	CODE	PPHT (€)
655.0019.02	TUYAU ALU 1M 97 901970	U	1130D.3	27,17
655.0020.45	TUYAU ALU 1M 111 901111	U	6648A.3	29,21
655.0021.64	TUYAU ALU 1M 125 901125	U	6649A.2	30,92
655.0026.30	TUYAU ALU 1M 153 901153	U	2320B.5	37,57



CONDUIT RIGIDE ALUMINIUM

Raccordement hotte de cuisine, sèche-linge et chauffe-eau. Ventilation. - Coude 45°



	DÉSIGNATION	UT	CODE	PPHT (€)
655.0011.36	COUDE BR.45D PLISSE ALU 097 394970	U	6657A.1	16,23
655.0011.54	COUDE BR.45D PLISSE ALU 111 394111	U	6660A.6	16,48
655.0013.22	COUDE BR.45D PLISSE ALU 125 394125	U	6663A.3	18,89

CONDUIT DE FUMÉE

CHEMINÉE



CONDUIT RIGIDE ALUMINIUM

Raccordement hotte de cuisine, sèche-linge et chauffe-eau. Ventilation. - Coude 45° - suite



	DÉSIGNATION	UT	CODE	PPHT (€)
655.0017.83	COUDE BR.45D PLISSE ALU 153 394153	U	2305B.4	25,47



CONDUIT RIGIDE ALUMINIUM

Raccordement hotte de cuisine, sèche-linge et chauffe-eau. Ventilation. - Coude 90°



	DÉSIGNATION	UT	CODE	PPHT (€)
655.0010.11	COUDE EQ90D PLISSE ALU 083 392830	U	6650A.8	14,44
655.0011.36	COUDE EQ90D PLISSE ALU 097 392970	U	6651A.7	16,23
655.0011.54	COUDE EQ90D PLISSE ALU 111 392111	U	6652A.6	16,48
655.0013.22	COUDE EQ90D PLISSE ALU 125 392125	U	6653A.5	18,89



CONDUIT RIGIDE ALUMINIUM

Raccordement hotte de cuisine, sèche-linge et chauffe-eau. Ventilation. - Té équerre



	DÉSIGNATION	UT	CODE	PPHT (€)
655.0028.29	TE EQUERRE ALUMINIUM 97 694970	U	11315.9	40,41
655.0028.43	TE EQUERRE ALUMINIUM 111 694111	U	6672A.2	40,62
655.0029.99	TE EQUERRE ALUMINIUM 125 694125	U	6675A.9	42,84



CONDUIT RIGIDE ALUMINIUM

Raccordement hotte de cuisine, sèche-linge et chauffe-eau. Ventilation. - Tampon



	DÉSIGNATION	UT	CODE	PPHT (€)
655.0008.39	TAMPON ALU 97 109970	U	11318.3	11,98
655.0010.26	TAMPON ALU 125 109125	U	2257B.2	14,66
655.0008.93	TAMPON ALU 111 109111	U	1131A.8	12,76
655.0012.80	TAMPON ALU 153 109153	U	1131E.9	18,28

CONDUIT DE FUMEE

CHEMINEE



TOLERIE EMAILLEE-NANTAISE

CONDUIT RIGIDE ALUMINIUM

Raccordement hotte de cuisine, sèche-linge et chauffe-eau. Ventilation. - Collier de suspension



	DÉSIGNATION	UT	CODE	PPHT (€)
655.0012.37	COLLIER DE SUSPENSION ALU 97 000970	U	1131H.3	17,67
655.0012.33	COLLIER DE SUSPENSION ALU 111 000111	U	2278B.7	17,62
655.0013.71	COLLIER DE SUSPENSION ALU 125 000125	U	2281B.2	19,58



TOLERIE EMAILLEE-NANTAISE

CONDUIT RIGIDE ALUMINIUM

Raccordement hotte de cuisine, sèche-linge et chauffe-eau. Ventilation. - Rosace



	DÉSIGNATION	UT	CODE	PPHT (€)
655.0006.77	ROSACE ALU 97 790970	U	6693A.7	9,67
655.0007.24	ROSACE ALU 111 790111	U	6696A.4	10,34
655.0007.92	ROSACE ALU 125 790125	U	6699A.1	11,32



TOLERIE EMAILLEE-NANTAISE

CONDUIT RIGIDE ALUMINIUM

Raccordement hotte de cuisine, sèche-linge et chauffe-eau. Ventilation. - Réduction



	DÉSIGNATION	UT	CODE	PPHT (€)
655.0025.42	REDUCTION ALU 111X97 591197	U	1131J.0	36,31
655.0026.15	REDUCTION ALU 125X111 592511	U	1131K.8	37,35
655.0028.00	REDUCTION ALU 139X125 593925	U	2260B.7	40,00



TOLERIE EMAILLEE-NANTAISE

CONDUIT RIGIDE INOX 304 - PRO

Pour gaz, fuel, charbon et bois - Coude 45 °



	DÉSIGNATION	UT	CODE	PPHT (€)
655.0021.79	COUDE BR45 PLISSE INOX 304 125 364125	U	27298.9	31,13
655.0023.88	COUDE BR45 PLISSE INOX 304 139 364139	U	27439.9	34,12
655.0026.17	COUDE BR45 PLISSE INOX 304 153 364153	U	27531.3	37,39



TOLERIE EMAILLEE-NANTAISE

CONDUIT RIGIDE INOX 304 - PRO

Pour gaz, fuel, charbon et bois - Coude 90° plissé



	DÉSIGNATION	UT	CODE	PPHT (€)
655.0021.79	COUDE E090 PLISSE INOX 304 125 362125	U	24753.6	31,13
655.0026.17	COUDE E090 PLISSE INOX 304 153 362153	U	24935.9	37,39

CONDUIT DE FUMEE

CHEMINEE



TOLERIE EMAILLEE-NANTAISE

CONDUIT RIGIDE INOX 304 - PRO

Pour gaz, fuel, charbon et bois - Coude 90° - 3 Parties



	DÉSIGNATION	UT	CODE	PPHT (€)
655.0048.05	COUDE INOX 3 PARTIES EQ.90 200 262200	U	6656A.2	68,65



TOLERIE EMAILLEE-NANTAISE

CONDUIT RIGIDE INOX 304 - PRO

Pour gaz, fuel, charbon et bois - Té équerre 90° - Mâle



	DÉSIGNATION	UT	CODE	PPHT (€)
655.0027.96	TE EQUERRE INOX 304 125 604125	U	6677A.7	39,94
655.0029.51	TE EQUERRE INOX 304 139 604139	U	6680A.2	42,16



TOLERIE EMAILLEE-NANTAISE

CONDUIT RIGIDE INOX 304 - PRO

Pour gaz, fuel, charbon et bois - Tuyau



	DÉSIGNATION	UT	CODE	PPHT (€)
655.0037.35	TUYAU INOX 304 1M00 125 601125	U	6670A.4	53,36
655.0041.73	TUYAU INOX 304 1M00 139 601139	U	6673A.1	59,61
655.0047.02	TUYAU INOX 304 1M00 153 601153	U	6676A.8	67,17
655.0063.76	TUYAU INOX 304 1M00 200 601200	U	6682A.0	91,08



TOLERIE EMAILLEE-NANTAISE

CONDUIT RIGIDE INOX 304 - PRO

Pour gaz, fuel, charbon et bois - Purge



	DÉSIGNATION	UT	CODE	PPHT (€)
655.0012.08	PURGE INOX 304 125 160125	U	6707A.1	17,26
655.0012.89	PURGE INOX 304 139 160139	U	6720A.4	18,42
655.0013.67	PURGE INOX 304 153 160153	U	6718A.8	19,53



TOLERIE EMAILLEE-NANTAISE

TUBAGE FLEXIBLE

Tubage souple double peau inox intérieur lisse - SUPER TEN LISS



	DÉSIGNATION	UT	CODE	PPHT (€)
655.0068.26	GAINÉ SUPER TEN LISS INOX 125/131 30M 057125	M	95868.6	97,52
655.0085.33	GAINÉ SUPER TEN LISS INOX 155/161 30M 057155	M	95871.0	121,90

CONDUIT DE FUMEE

VENTOUSE



RACCORDEMENT FUMEEES

Terminal



	DÉSIGNATION	UT	CODE	PPHT (€)
551.0147.00	TERMINAL HORIZ.TELES.60/100 AZ414 7716780194	U	1986B.2	210,00



DUALIS BT / EI

Kit - Kit R-FIT



	DÉSIGNATION	UT	CODE	PPHT (€)
658.0154.66	RENOVATION KIT R-FIT 60/100 E.P 17060798/0	U	222RB.4	154,66



ROLUX GAZ CONCENTRIQUE

Conduit - Alu/PVC blanc - Ø 60/100



	DÉSIGNATION	UT	CODE	PPHT (€)	ECOPART (€)
657.0041.00	CONDUIT CONC.ALU/PVC GAZ 60/100 500MM 227351	U	1532B.1	54,67	0,01

VENTOUSE CONDENSATION



RACCORDEMENT FUMEEES

Terminal



	DÉSIGNATION	UT	CODE	PPHT (€)	ECOPART (€)
553.0071.25	TERMINAL HOR.60/100 L.800MM DY908 100016485	U	5646C.3	95,00	
553.0093.60	TERMINAL HOR.PPS 60/100 800MM DY871 100008296	U	0226D.0	146,80	22,00



RACCORDEMENT FUMEEES

Terminal

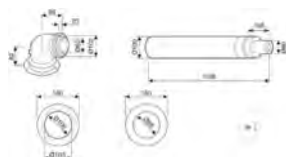

	DÉSIGNATION	UT	CODE	PPHT (€)
551.0075.60	TERMINAL HORIZ.COND.60/100 AZB1110 7736200349	U	05954.3	108,00



3CE P MULTI+ POUR CHAUDIERE GAZ CONDENSATION

Coudes - 45°



	DÉSIGNATION	UT	CODE	PPHT (€)
658.0076.69	ELEMENT COUDE 45 130 MULTI+INT 17130421/9999	U	30892.4	102,25

CONDUIT DE FUMEE

VENTOUSE CONDENSATION



3CE P MULTI+ POUR CHAUDIERE GAZ CONDENSATION

Coudes - 45°

- suite



	DÉSIGNATION	UT	CODE	PPHT (€)
658.0069.62	ELEMENT COUDE 45 80 MULTI+INT. 17080421/9999	U	1768U.9	92,83



3CE P MULTI+ POUR CHAUDIERE GAZ CONDENSATION

Eléments - Droits



	DÉSIGNATION	UT	CODE	PPHT (€)
658.0107.87	ELEMENT DRT.1000 110 MULTI+INT 17110305/9999	U	8263S.9	143,83
658.0065.29	ELEMENT DROIT 250 80 MULTI+INT 17080403/9999	U	88471.8	74,19
658.0097.30	ELEMENT DRT.1000 080 MULTI+INT 17080405/9999	U	9849D.8	129,73
658.0139.67	ELEMENT DRT.1000 130 MULTI+INT 17130405/9999	U	2008G.3	186,23



3CE P MULTI+ POUR CHAUDIERE GAZ CONDENSATION

Eléments - Réglables



	DÉSIGNATION	UT	CODE	PPHT (€)
658.0121.40	ELEMENT REG.390-640 110 MULTI+I 17110329/9999	U	8264A.2	161,86



3CE P MULTI+ POUR CHAUDIERE GAZ CONDENSATION

Eléments - Coudés



	DÉSIGNATION	UT	CODE	PPHT (€)
658.0071.78	ELEMENT COUDE 45 110 MULTI+INT 17110321/9999	U	8263V.2	95,70



3CE P MULTI+ POUR CHAUDIERE GAZ CONDENSATION

Kit 3CE P Multi+ - Kit étage



	DÉSIGNATION	UT	CODE	PPHT (€)
658.0476.63	KIT ETAGE 110 MULTI+ INT 17110396/0	U	8266R.8	635,51
658.0569.53	KIT ETAGE 130/200 MULTI+INT 17130496/0	U	8730Y.1	759,37
658.0435.00	KIT ETAGE 80 MULTI+ INT 17080496/0	U	1784T.2	580,00

Le PPHT comprend l'ecopart (€)

CONDUIT DE FUMEE

VENTOUSE CONDENSATION

cheminées Poujolat

3CE P MULTI+ POUR CHAUDIERE GAZ CONDENSATION

Kit 3CE P Multi+ - Kit niveau



	DÉSIGNATION	UT	CODE	PPHT (€)
658.0211.31	KIT NIVEAU 110 MULTI+INT 17110395/0	U	8263T.7	281,75
658.0220.97	KIT NIVEAU 130/200 MULTI+ INT 17130495/0	U	17636.2	294,63

cheminées Poujolat

3CE P MULTI+ POUR CHAUDIERE GAZ CONDENSATION

Kit 3CE P Multi+ - Kit toit terrasse

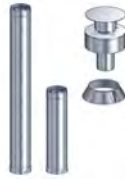

	DÉSIGNATION	UT	CODE	PPHT (€)
658.0292.64	KIT TOIT TERRASSE 110/160 MULTI+IN 17110398/0	U	8266U.1	390,19

cheminées Poujolat

3CE P MULTI+ POUR CHAUDIERE GAZ CONDENSATION

Plaque propreté



	DÉSIGNATION	UT	CODE	PPHT (€)
658.0039.58	PLAQUE PROPRETE PENTE 80/125MULTI+ 17080716/0	U	0017F.8	39,58

cheminées Poujolat

3CE P MULTI+ POUR CHAUDIERE GAZ CONDENSATION

Solin

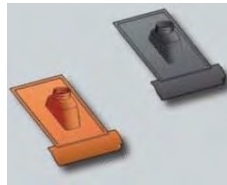

	DÉSIGNATION	UT	CODE	PPHT (€)
658.0059.70	SOLIN TUILE+KE 15-30 110M+INT 17110367/311	U	1471B.4	79,60

cheminées Poujolat

3CE P MULTI+ POUR CHAUDIERE GAZ CONDENSATION

Support - Toit



	DÉSIGNATION	UT	CODE	PPHT (€)
658.0050.35	SUPPORT AU TOIT 160 SLCD 45160165/9999	U	8328B.4	67,13

cheminées Poujolat

3CE P MULTI+ POUR CHAUDIERE GAZ CONDENSATION

Terminal - Vertical



	DÉSIGNATION	UT	CODE	PPHT (€)
658.0256.02	TERM VERT AERO 110-160 BRUN 17110355/8004	U	265SV.3	320,02
658.0260.99	TERM VERT AERO 130-200 MULTI+ 17130455/9999	U	271JZ.7	326,24

CONDUIT DE FUMEE

VENTOUSE CONDENSATION

cheminées Poujolat

DUALIS POUR CHAUDIERE A CONDENSATION

Conduit - Flexible - Flexcondens



	DÉSIGNATION	UT	CODE	PPHT (€)
658.0026.18	BOBINE FLEXIBLE PP D80/90 50ML 27080605/0	M	3055J.8	34,90

cheminées Poujolat

DUALIS POUR CHAUDIERE A CONDENSATION

Conduit - Raccords - Flexcondens



	DÉSIGNATION	UT	CODE	PPHT (€)
658.0028.56	RACCORD FLEX/FLEX D 80/90 27080643/0	U	29895.0	38,08

cheminées Poujolat

DUALIS POUR CHAUDIERE A CONDENSATION

Coude - 90°



	DÉSIGNATION	UT	CODE	PPHT (€)
658.0031.02	ELEMENT COUDE 90 60/100 E.P 17060731/0	U	14732.2	41,36
658.0043.60	ELEMENT COUDE 90 80/125 GP DUALIS 17080731/0	U	8268R.6	58,13

cheminées Poujolat

DUALIS POUR CHAUDIERE A CONDENSATION

Coude - 45°



	DÉSIGNATION	UT	CODE	PPHT (€)
658.0023.23	ELEMENT COUDE 45 60/100 E.P 17060721/0	U	1474H.8	30,97
658.0027.18	ELEMENT COUDE 45 80/125 GP DUALIS 17080721/0	U	8147P.7	36,24

cheminées Poujolat

DUALIS POUR CHAUDIERE A CONDENSATION

Elément droit



	DÉSIGNATION	UT	CODE	PPHT (€)
658.0041.46	ELEMENT DROIT 1000 60/100 E.P 17060705/0	U	14730.6	55,28
658.0059.29	ELEMENT DROIT 1000 80/125 GP 17080705/0	U	81910.0	79,05
658.0068.92	ELEMENT DROIT 2000 60/100 E.P 17060707/0	U	29169.0	91,89
658.0088.25	ELEMENT DROIT 2000 80/125 G.P 17080707/0	U	29170.0	117,67
658.0024.80	ELEMENT DROIT 250 60/100 E.P 17060703/0	U	29153.4	33,06
658.0030.43	ELEMENT DROIT 500 60/100 E.P 17060704/0	U	14734.8	40,57
658.0042.14	ELEMENT DROIT 500 80/125GP 17080704/0	U	8191W.7	56,18
658.0032.80	ELEMENT DROIT 250 80/125 G.P 17080703/0	U	8601T.8	43,74

CONDUIT DE FUMEE

VENTOUSE CONDENSATION

cheminées
Poujoulat

DUALIS POUR CHAUDIERE A CONDENSATION

Flexible - Bride - Flexcondens



	DÉSIGNATION	UT	CODE	PPHT (€)
658.0007.74	BRIDE DE CENTRAGE 80 FLA 27080765/0	U	2992V.3	7,74

cheminées
Poujoulat

DUALIS POUR CHAUDIERE A CONDENSATION

Kit C9 80PPA - Dualis 60/100EP et 80/125GP



	DÉSIGNATION	UT	CODE	PPHT (€)
658.0238.45	KIT C9 RACC80/125 80PPA BRIQUE 27080583/0	U	29880.2	317,93
658.0238.45	KIT C9 RACC60/100 80PPA BRIQUE 27080581/0	U	8754R.7	317,93

cheminées
Poujoulat

DUALIS POUR CHAUDIERE A CONDENSATION

Support - Colliers à platine



	DÉSIGNATION	UT	CODE	PPHT (€)
658.0015.99	COLLIER DUALIS D 100 A PLATINE 17060740/0	U	167PT.9	15,99
658.0019.04	COLLIER DUALIS D 125 A PLATINE 17080740/0	U	172KQ.4	19,04

cheminées
Poujoulat

DUALIS POUR CHAUDIERE A CONDENSATION

Support - Colliers à pointe



	DÉSIGNATION	UT	CODE	PPHT (€)
658.0008.03	COLLIER UNIVERSEL CU 60 17060319/0	U	1473D.8	10,71
658.0009.82	COLLIER UNIVERSEL CU 80 17080519/0	U	1475U.3	13,09

cheminées
Poujoulat

DUALIS POUR CHAUDIERE A CONDENSATION

Solin et fixation - terminal vertical - Solin



	DÉSIGNATION	UT	CODE	PPHT (€)
658.0051.56	SOLIN FLEXIBLE 15-45 BRIQUE 17080767/0	U	28116.2	68,75
658.0043.64	SOLIN TOIT PLAT 80 G.A NOIR 17080571/0	U	14727.2	58,19

CONDUIT DE FUMEE

VENTOUSE CONDENSATION

cheminées
Poujoulat

DUALIS POUR CHAUDIERE A CONDENSATION

Solin et fixation - terminal vertical - Fixation



	DÉSIGNATION	UT	CODE	PPHT (€)
658.0015.26	SUPPORT UNIVERSEL 0-80/125 17080165/0	U	1475R.0	20,35
658.0009.97	SUPPORT UNIVERSEL 100 BF 17100065/0	U	1472Y.8	13,29

cheminées
Poujoulat

DUALIS POUR CHAUDIERE A CONDENSATION

Terminal - Vertical



	DÉSIGNATION	UT	CODE	PPHT (€)
658.0118.88	TERMINAL VERT.60/100 E.P BRIQUE 17060752/0	U	1473M.0	158,51
658.0133.31	TERMINAL VERT.80/125 G.P BRIQUE 17080752/0	U	1474X.8	177,75
658.0118.88	TERMINAL VERTICAL 60/100 E.P NOIR 17060751/0	U	1471V.5	158,51

cheminées
Poujoulat

DUALIS POUR CHAUDIERE A CONDENSATION

Terminal - Horizontal



	DÉSIGNATION	UT	CODE	PPHT (€)
658.0039.57	TERMINAL HOR.60/100 E.P PLASTIC 17060762/0	U	0062Q.3	52,76

cheminées
Poujoulat

DUALIS POUR CHAUDIERE A CONDENSATION

Terminal - Kit Terminal horizontal



	DÉSIGNATION	UT	CODE	PPHT (€)
658.0091.24	TERMINAL HOR.60/100 SD/ELM 17060794/0	U	194JV.8	91,24

cheminées
Poujoulat

KIT AVEC PRISE D'AIR B23P



	DÉSIGNATION	UT	CODE	PPHT (€)
658.0239.30	KIT B23P RACC80/125 80PPA BRIQUE 27080585/0	U	29887.7	239,30

ubbink
Build smart

CHEMILUX PPTL CONDENSATION GAZ ET FIOUL

Kit 2 en 1 - Ø 80/125-80



	DÉSIGNATION	UT	CODE	PPHT (€)	ECOPART (€)
657.0249.90	ENTREE PLAF.+MUR.CHEMILUX D80-KIT-NOIR 184448	U	8717X.0	249,96	0,06

Le PPHT comprend l'ecopart (€)

CONDUIT DE FUMEE

VENTOUSE CONDENSATION



CHEMILUX PPTL CONDENSATION GAZ ET FIOUL

Coude 45° - Ø 80 hors logement (X2)



	DÉSIGNATION	UT	CODE	PPHT (€)	ECOPART (€)
657.0013.23	COUDE PPTL 45 D.80 222954	U	67372.3	17,65	0,01



RENOLUX CONDENSATION

Kit 2 en 1 - Ø 80/125 - 80



	DÉSIGNATION	UT	CODE	PPHT (€)	ECOPART (€)
657.0297.68	ENTREE PLAF.+MUR.RENOLUX D80-KIT-OCRE 184445	U	8717Y.8	396,95	0,05



ROLUX CONDENSATION GAZ ET FIOUL CONCENTRIQUE

Terminal anti-glace vertical PPTL/PP - Ø 60/100



	DÉSIGNATION	UT	CODE	PPHT (€)	ECOPART (€)
657.0134.38	TERMINAL VERTICAL 60/100 C OCRE 5G 184251	U	8692W.1	179,20	0,03



ROLUX CONDENSATION GAZ ET FIOUL CONCENTRIQUE

Terminal excentrique horizontal PP/PVC - Ø 80/125



	DÉSIGNATION	UT	CODE	PPHT (€)	ECOPART (€)
657.0097.13	TERMINAL HOR.COND.PPTL/PVC 80/125 BLC 223150	U	4152B.4	129,52	0,01



ROLUX RENOFIT® 60/100

Terminal rénovation - Kit

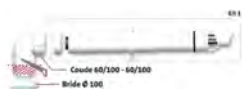

	DÉSIGNATION	UT	CODE	PPHT (€)	ECOPART (€)
657.0124.18	KIT TERMINAL H 60/100 RENOFIT +COUDE 229411	U	3040K.4	165,60	0,03

Le PPHT comprend l'ecopart (€)

CONDUIT DE FUMEE

VENTOUSE CONDENSATION



ROLUX ET CHEMILUX

Conduit - PPTL/PP blanc - Ø 60/100



	DÉSIGNATION	UT	CODE	PPHT (€)	ECOPART (€)
657.0035.72	CONDUIT 60/100 500MM PPTL/PP SEKURIT 229302	U	4119Q.8	47,63	0,01
657.0044.99	CONDUIT 60/100 1000MM PPTL/PP SEKURIT 229303	U	4122R.1	60,01	0,02



ROLUX ET CHEMILUX

Conduit - PPTL/PP blanc - Ø 80/125



	DÉSIGNATION	UT	CODE	PPHT (€)	ECOPART (€)
000.0045.46	CONDUIT CONDENS.PPTL PVC 500MM 80/125 229531	U	208SC.0	60,64	0,02
000.0065.13	CONDUIT CONDENS.PPTL PVC 1000MM 80/125 229532	U	208SB.2	86,88	0,04



ROLUX ET CHEMILUX

Coude 45° - PPTL/PVC - Ø 60/100



	DÉSIGNATION	UT	CODE	PPHT (€)	ECOPART (€)
657.0033.76	COUDE COND.60/100 45 PPTL/PP SEKURIT 229200	U	4123X.7	33,77	0,01



ROLUX ET CHEMILUX

Coude 45° - PPTL/PVC - Ø 80/125



	DÉSIGNATION	UT	CODE	PPHT (€)	ECOPART (€)
000.0028.85	COUDE COND.80/125 45 PPTL/PVC SEKU. 229500	U	208SE.5	38,48	0,01



ROLUX ET CHEMILUX

Coude 87° - PPTL/PVC - Ø 60/100



	DÉSIGNATION	UT	CODE	PPHT (€)	ECOPART (€)
657.0032.35	COUDE COND.60/100 87 PPTL/PP SEKURIT 229232	U	4123Y.5	43,14	0,01

CONDUIT DE FUMEE

VENTOUSE CONDENSATION



ROLUX ET CHEMILUX
Coude 87° - PPTL/PVC - Ø 80/125



DÉSIGNATION	UT	CODE	PPHT (€)	ECOPART (€)
000.0048.82 COUDE CONDENS.PPTL PVC 87DEG 80/125 229520	U	208SD.8	65,10	0,01



ROLUX ET CHEMILUX
Flexible PPTL en rouleaux - Ø 80



DÉSIGNATION	UT	CODE	PPHT (€)	ECOPART (€)
657.0014.02 CONDUIT FLEXIBLE PPTL D80 50M 330054	M	318VB.6	35,07	0,01

ACCESSOIRES DE FUMISTERIE



ACCESSOIRES VENTOUSE
Adaptateur



DÉSIGNATION	UT	CODE	PPHT (€)
504.0017.50 ADAPTEUR CONCENTR.80/125 FC-CA80 7738112714	U	300TT.2	25,00
504.0017.25 ADAPTEUR CONCENTR.60/100 FC-CA60 7738112636	U	307B0.7	23,00



ACCESSOIRES VENTOUSE
Adaptateur

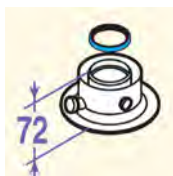

DÉSIGNATION	UT	CODE	PPHT (€)	ECOPART (€)
553.0052.50 ADAPTEUR AIR/FUMEE D80/125 HR38 S100465	U	36917.3	92,00	22,00



ACCESSOIRES 3CE P MULTI + INTERIEUR
Bouchon



DÉSIGNATION	UT	CODE	PPHT (€)
658.0050.66 BOUCHON SECURITE MULTI+ BDS 080M+ 17080407/0	U	9402P.5	63,32

CONDUIT DE FUMEE

ACCESSOIRES DE FUMISTERIE



ACCESSOIRES 3CE P MULTI + INTERIEUR

Conduit de liaison



DÉSIGNATION	UT	CODE	PPHT (€)
658.0100.18 CONDUIT LIAISON 80/125 -KIT- 17080409/0	U	8134F.9	133,58



ACCESSOIRES 3CE P MULTI + INTERIEUR

Liquide pour machine - Liquide pour générateur de fumée artificielle



DÉSIGNATION	UT	CODE	PPHT (€)
658.0044.39 LIQUIDE POUR MACHINE 1L 55001002/0	U	87555.9	55,49



ACCESSOIRES DUALIS - VENTOUSE

Adaptateurs et accessoires - Dualis Condensation



DÉSIGNATION	UT	CODE	PPHT (€)
658.0036.32 ADAPTEUR DUA.CONDENS.ADA 60EP/80 17080785/0	U	4441R.5	48,43



ACCESSOIRES PGI POUR POELE A PELLETS

Support et Maintien - Support au toit



DÉSIGNATION	UT	CODE	PPHT (€)
658.0049.66 SUPPORT AU TOIT 130 SLCD 45130165/9999	U	4644J.4	66,22



ACCESSOIRES VENTOUSE

Busse - Sortie verticale

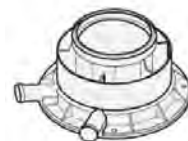

DÉSIGNATION	UT	CODE	PPHT (€)
782.0042.00 BUSE SORTIE VERT. 60/100 0010031029	U	269MH.1	42,00



ACCESSOIRES TUBAGE FLEXIBLE

Té de tubage + purge - Inox 304 - Equerre

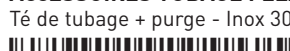

DÉSIGNATION	UT	CODE	PPHT (€)
655.0068.26 TE TUBAGE 90 +PURGE INOX 125 PIQ.MALE 884125	U	45099.9	97,52

Le PPHT comprend l'ecopart (€)

CONDUIT DE FUMEE

ACCESSOIRES DE FUMISTERIE



ACCESSOIRES TUBAGE FLEXIBLE

Collier de tubage - Inox



	DÉSIGNATION	UT	CODE	PPHT (€)
655.0016.48	COLLIER DE TUBAGE INOX 125X131 066125	U	57561.3	23,54



ACCESSOIRES TUBAGE FLEXIBLE

Chapeau chinois inox



	DÉSIGNATION	UT	CODE	PPHT (€)
655.0048.99	CHAPEAU CHINOIS INOX 80A111 000001	U	6617A.0	69,99
655.0054.26	CHAPEAU CHINOIS INOX 120A140 000002	U	6427A.0	77,52
655.0070.62	CHAPEAU CHINOIS INOX 153A180 000003	U	6318A.2	100,88



ACCESSOIRES TUBAGE FLEXIBLE

Raccordement mural alu 16 cm



	DÉSIGNATION	UT	CODE	PPHT (€)
655.0010.38	RACCORD MUR.VIROLLE ALU/GAZ 16CM D.125 916125	U	5438G.6	13,84



GAINÉ DE RACCORDEMENT GAZ

Gaine accordéon - 0.45m à 1.50m



	DÉSIGNATION	UT	CODE	PPHT (€)
655.0023.49	GAINÉ EXT.ALU G.+RAC.0M45/1M50 97/103 015097	U	0470G.6	33,55
655.0025.13	GAINÉ EXT.ALU G.+RAC.0M45/1M50 111/116 015111	U	0463H.3	35,90
655.0026.36	GAINÉ EXT.ALU G.+RAC.0M45/1M50 125/131 015125	U	0463I.1	37,66



GAINÉ DE RACCORDEMENT GAZ

Raccord aluminium - Pour gaine accordéon



	DÉSIGNATION	UT	CODE	PPHT (€)
655.0011.60	RACCORD ALU GAZ 125X131 014125	U	0802J.0	15,46

Le PPHT comprend l'ecopart (€)

CONDUIT DE FUMEE

ACCESSOIRES DE FUMISTERIE



CHEMILUX PPTL CONDENSATION GAZ ET FIOUL

Accessoires complémentaires - Kit Rénovation Rénosouche®



	DÉSIGNATION	UT	CODE	PPHT (€)	ECOPART (€)
657.0154.73	KIT SORTIE HORIZ.RENOSOUCHE D80 290409	U	165L4.1	154,77	0,04



ROLUX ET CHEMILUX ACCESSOIRES

Araignée de centrage - Ø 80



	DÉSIGNATION	UT	CODE	PPHT (€)	ECOPART (€)
657.0003.06	ARAIGNEE CONDUIT FLEXIBLE MAX 250/80 716083	U	90202.3	4,09	0,01



ROLUX ET CHEMILUX ACCESSOIRES

Accessoires pour terminal - Kit départ



	DÉSIGNATION	UT	CODE	PPHT (€)	ECOPART (€)
657.0108.34	KIT DEPART 60/100 ROLUX CONDENS.UNIV. 290232	U	9130J.4	144,45	



ROLUX ACCESSOIRES

Bavette standard 500x500 Ubiflex - Terminal ocre



	DÉSIGNATION	UT	CODE	PPHT (€)	ECOPART (€)
657.0059.32	BAVETTE TERMINAL OCRE 25A45 189911	U	3663H.5	79,21	0,12

Pour plus d'infos,
consultez
le CAHIER TECHNIQUE
page 14

100% Exclusivités

TEKNIK



par **RBM**

ROBINETTERIE DE RADIATEUR

Têtes
thermostatiques
VT 0,2 et VT 0,4



Robins
thermostatiques
ou manuels...



Coudes et tés



**Le kit
thermostatique**



Uniquement chez
RICHARDSON

RADIATEUR

RADIATEUR ACIER

De Dietrich

ARTIS - HORIZONTAL 4 ORIFICES

Modèle 22HR - Habillé réversible



	DÉSIGNATION	UT	CODE	PPHT (€)
583.0231.00	RAD.AC.ARTIS 22HR 700X800 1488W 100017069	U	6034B.3	308,00

KERMI

THERM X2 - FK0

Profilé compact - Type 11



	DÉSIGNATION	UT	CODE	PPHT (€)
585.0129.90	RAD.PROFILK11 593W 750X500 15E FK0110705W02	U	88707.5	162,38
585.0247.40	RAD.PROFILK11 1067W 750X900 27E FK0110709W02	U	88793.5	247,40

KERMI

THERM X2 - FK0

Profilé compact - Type 12



	DÉSIGNATION	UT	CODE	PPHT (€)
585.0149.28	RAD.PROFILK12 590W 750X400 12E FK0120704W02	U	89235.6	199,04
585.0172.17	RAD.PROFILK12 738W 750X500 15E FK0120705W02	U	89245.5	229,56
585.0217.94	RAD.PROFILK12 1033W 750X700 21E FK0120707W02	U	89250.5	290,59
585.0286.60	RAD.PROFILK12 1475W 750X1000 30E FK0120710W02	U	89325.5	382,14

KERMI

THERM X2 - FK0

Profilé compact - Type 22



	DÉSIGNATION	UT	CODE	PPHT (€)
585.0187.18	RAD.PROFIL-K T22 750X400 795W FK0220704W02	U	89552.4	249,57
585.0213.20	RAD.PROFILK22 994W 750X500 FK0220705W02	U	89554.0	284,26
585.0291.24	RAD.PROFILK22 1590W 750X800 22E FK0220708W02	U	89560.7	388,32
585.0317.25	RAD.PROFIL-K T22 750X900 1788W FK0220709W02	U	5024S.5	423,00
585.0343.27	RAD.PROFILK22 1987W 750X1000 30E FK0220710W02	U	89575.5	457,69

RADIATEUR ALU

fondital

ACCESSOIRES

Pour Calidor, Garda, Master et Scirocco et blitz



	DÉSIGNATION	UT	CODE	PPHT (€)
025.0000.22	JOINT P.NIPPLE A10 530105	U	43561.0	0,29
025.0000.74	NIPPLE ACIER A2	U	43554.5	0,99

RADIATEUR

RADIATEUR ALU



ACCESSOIRES

Kit montage - bouchon



	DÉSIGNATION	UT	CODE	PPHT (€)
025.0027.52	CONSOLE KIT MONTAGE A81 550104	U	91836.7	36,70



CALIDOR

B2 700/80 - Blanc



	DÉSIGNATION	UT	CODE	PPHT (€)
581.0274.53	RAD.CALIDOR B2 700/80 800W 6E BLC V62215406	U	0915N.6	366,04
581.0457.54	RAD.CALIDOR B2 700/80 1334W 10E V62215410	U	0916X.6	610,06



CALIDOR

B2 800/80 - Blanc



	DÉSIGNATION	UT	CODE	PPHT (€)
581.0515.53	RAD.CALIDOR B2 800/80 1486W 10E BLC V62216410	U	0832C.8	687,37

RADIATEUR DECORATIF



CALISSIA

Radiateur décoratif de chauffage central horizontal



	DÉSIGNATION	UT	CODE	PPHT (€)	ECOPART (€)
673.0449.60	RAD.CALISSIA CONNECTE HOR.750W 529807	U	7537Y.8	563,67	1,67

RADIATEUR ELECTRIQUE



ACCESSIO

Radiateur électrique chaleur douce - Horizontal



	DÉSIGNATION	UT	CODE	PPHT (€)	ECOPART (€)
673.0441.60	RAD.ACCESSIO DIGITAL HOR.973X575 2000W 524920	U	0467R.2	553,67	1,67

Le PPHT comprend l'ecopart (€)

RADIATEUR

RADIATEUR ELECTRIQUE



AGILIA PILOTAGE INTELLIGENT CONNECTE
Radiateur électrique chaleur douce - Horizontal
Pilotage intelligent



	DÉSIGNATION	UT	CODE	PPHT (€)	ECOPART (€)
673.0367.20	RAD.HORIZ.AGILIA 750W BLC 503107	U	9481R.5	460,67	1,67
673.0419.20	RAD.HORIZ.AGILIA 1000W BLC 503110	U	9481T.1	525,67	1,67
673.0556.00	RAD.HORIZ.AGILIA 1500W BLC 503115	U	9481U.8	696,67	1,67
673.0682.40	RAD.HORIZ.AGILIA 2000W BLC 503120	U	55959.1	854,67	1,67



SOKIO

Radiateur à inertie - Corps de chauffe aluminum - Horizontal



	DÉSIGNATION	UT	CODE	PPHT (€)	ECOPART (€)
673.0315.00	RAD.DIG.HORIZ.SOKIO 1000W BLC 503109	U	278N9.9	316,67	1,67
673.0399.00	RAD.DIG.HORIZ.SOKIO 1500W BLC 503113	U	280JL.4	400,67	1,67
673.0478.00	RAD.DIG.HORIZ.SOKIO 2000W BLC 503114	U	280JU.7	479,67	1,67

RADIATEUR SECHE-SERVIETTES



EXCLUSIVITES RICHARDSON PAR KERMI
Sèche-serviettes droit - Version Eau chaude



	DÉSIGNATION	UT	CODE	PPHT (€)
592.0085.82	SECHE-S.EC.D.EAZY 345W 76X49 LS01M0800502XXN	U	2925X.1	122,60
592.0096.88	SECHE-S.EC.D.EAZY 514W 117X49 LS01M1200502XXN	U	29271.4	138,40
592.0107.87	SECHE-S.EC.D.EAZY 663W 150X49 LS01M1500502XXN	U	2927A.4	154,10
592.0118.09	SECHE-S.EC.D.EAZY 806W 179X49 LS01M1800502XXN	U	2927M.0	168,70



EXCLUSIVITES RICHARDSON PAR KERMI
Sèche-serviettes droit - Version Electrique



	DÉSIGNATION	UT	CODE	PPHT (€)	ECOPART (€)
592.0174.09	SECHE-S.EL.D.EAZY 400W 76X49 LSE100800502BXN	U	47912.1	250,37	1,67
592.0183.47	SECHE-S.EL.D.EAZY 600W 117X49 LSE101200502BXN	U	4791T.7	263,77	1,67
592.0220.85	SECHE-S.EL.D.EAZY 800W 179X49 LSE101800502BXN	U	4793V.0	317,17	1,67

RADIATEUR

RADIATEUR SECHE-SERVIETTES

ACOVA

ATOLL SPA

TSL-TSL0 - Radiateur Sèche-serviettes - Chauffage électrique - Acier - TSL - Blanc



	DÉSIGNATION	UT	CODE	PPHT (€)	ECOPART (€)
587.0299.49	SECHE-SERV.ATOLL SPA EL. 500W TSL-050-050-TF	U	6044B.1	376,03	1,67
587.0313.27	SECHE-SERV.ATOLL SPA EL. 750W TSL-075-050-TF	U	6041B.4	393,26	1,67

ACOVA

FASSANE SPA

FAS - Radiateur Sèche-serviettes Symétrique - Chauffage Central - Acier - FAS - Blanc



	DÉSIGNATION	UT	CODE	PPHT (€)	ECOPART (€)
587.0359.86	SECHE-SERV.FASSANE SPA EC 625W FAS-133-050	U	1406L.4	449,84	0,02

atlantic

2012 DIGITAL

Radiateur Sèche-serviettes - Chauffage électrique - Acier



	DÉSIGNATION	UT	CODE	PPHT (€)	ECOPART (€)
673.0205.60	SECHE-SERV.2012 DIGIT 750W BLC 833621	U	356VD.2	258,67	1,67

atlantic

ADELIS DIGITAL CONNECTE

Radiateur Sèche-serviettes électrique - Blanc sans soufflerie



	DÉSIGNATION	UT	CODE	PPHT (€)	ECOPART (€)
673.0336.00	SECHE-SERV.ADELIS DIGITAL 500W BLC BR. 861911	U	323MK.1	421,67	1,67
673.0494.00	SECHE-SERV.ADELIS DIGITAL 750W BLC BR. 861912	U	31967.2	495,67	1,67
673.0445.60	SECHE-SERV.ADELIS DIGITAL 1000W BLC BR 861913	U	327BK.3	558,67	1,67

atlantic

ADELIS DIGITAL CONNECTE

Radiateur Sèche-serviettes électrique - Blanc avec soufflerie



	DÉSIGNATION	UT	CODE	PPHT (€)	ECOPART (€)
673.0417.60	SECHE-SERV.ADELIS DIGITAL 1500W BLC BR 861914	U	33156.1	581,67	1,67
673.0503.20	SECHE-SERV.ADELIS DIGITAL 1750W BLC BR 861916	U	320ED.9	630,67	1,67

RADIATEUR

RADIATEUR SECHE-SERVIETTES

atlantic

DORIS DIGITAL

Radiateur Sèche-serviettes - Chauffage électrique - Blanc avec soufflerie



	DÉSIGNATION	UT	CODE	PPHT (€)	ECOPART (€)
673.0369.60	SECHE-SERV.DORIS ELEC.500+1000W B.BR 851127	U	231EA.4	463,67	1,67

**VOTRE
ESPACE PRO,
LA CLÉ DE TOUS
VOS SUCCÈS !**



MON ESPACE PRO
www.richardson.fr



Rendez-vous vers
votre espace pro



Le PPHT comprend l'ecopart (€)

100% Exclusivités Carrelage



UPcity
par **Roca**



Tendance

Les gammes exclusives,
Le meilleur atout des Pros

- Des prix publics attractifs
- La qualité des grandes marques
- Produits et pièces détachées disponibles rapidement

Retrouvez tous les produits
exclusifs dans nos catalogues !



RICHARDSON

Le PPHT comprend l'ecopart (€)

PLANCHER CHAUFFANT

DALLE



PLAQUE ISOLANTE A PLOT RENFORCE

Résidia



DÉSIGNATION	UT	CODE	PPHT (€)	ECOPART (€)
590.0025.24 PLAQUE A PLOTS RESIDIA 24/54 12250151001	M²	2953B.9	29,70	0,01

ACCESSOIRES DE PLANCHER CHAUFFANT



RACCORDEMENT PLANCHER CHAUFFANT

Kit de câblage



DÉSIGNATION	UT	CODE	PPHT (€)	ECOPART (€)
565.0043.20 KIT CABLAGE PCBT DIRECT HA255 7624902	U	7636K.5	57,62	0,02



AGRAFE

Medium



DÉSIGNATION	UT	CODE	PPHT (€)
590.0067.63 AGRAFE MEDIUM -BTE 400- REHAU 13406031001	U	63407.1	79,56



ACCESSOIRES POUR PLAQUE ISOLANTE



DÉSIGNATION	UT	CODE	PPHT (€)
590.0109.73 PONTET DE FIXATION -500P- 12592681002	U	80449.2	129,09

ROBINET ET ACCESSOIRES RADIATEUR

ROBINET DECOR

Danfoss

RACCORD BICONE

Pour tuyau Alupex - À visser



	DÉSIGNATION	UT	CODE	PPHT (€)
452.0005.92	RACCORD VISS.TUBE MULTIC.16X2 F3/4 01364186	U	352KW.9	7,89

J+0 100% DISPO



L'atout LIBRE-SERVICE

- Un large choix de produits
- Tous les produits de ce catalogue à votre disposition
- Une équipe à votre service

100% Exclusivités Sèche-serviettes

eazy
par KERMI



Pro

Les gammes exclusives,
Le meilleur atout des Pros

- Des prix publics attractifs
- La qualité des grandes marques
- Produits et pièces détachées disponibles rapidement

Retrouvez tous les produits
exclusifs dans nos catalogues !



RICHARDSON

Le PPHT comprend l'ecopart (€)

ROBINET ET ACCESSOIRES RADIATEUR

ROBINET THERMOSTATIQUE



ENSEMBLE THERMOSTATIQUE

Tête + corps + raccord - Kit Sensity
- Equerre



DÉSIGNATION	UT	CODE	PPHT (€)	ECOPART (€)
451.0070.07 KIT SENSITY M30 + R858 EQ.1/2" RK8584241	U	7180S.1	70,09	0,02



TETE THERMOSTATIQUE

Avec élément liquide - Connexion M28
- Senso



DÉSIGNATION	UT	CODE	PPHT (€)	ECOPART (€)
451.0046.04 TETE THERMOSTAT.LIQU.SENSO TH M28 R100000	U	0592R.0	46,06	0,02



CORPS THERMOSTATIQUE

808-R808 - Corps équerre M28



DÉSIGNATION	UT	CODE	PPHT (€)	ECOPART (€)
451.0033.36 CORPS THERMOST.EQ.R808 3/8" M28 R808603	U	0165T.3	33,38	0,02
451.0034.43 CORPS THERMOST.EQ.R808 1/2" M28 R808604	U	0165U.0	34,45	0,02
451.0036.32 CORPS THERMOST.EQ.R808 3/4" M28 R808606	U	0163U.2	48,45	0,02



CORPS THERMOSTATIQUE

809-R809 - Corps droit M28



DÉSIGNATION	UT	CODE	PPHT (€)	ECOPART (€)
451.0025.39 CORPS THERMOST.DR.R809 3/8" M28 R809603	U	0164I.3	33,87	0,02
451.0026.31 CORPS THERMOST.DR.R809 1/2" M28 R809604	U	0162V.1	35,10	0,02



TETE MANUELLE

RA 2000 - Volant manuel



DÉSIGNATION	UT	CODE	PPHT (€)
452.0005.06 TETE MANUELLE VOLANT MAN.P.RA 2000 013G5002	U	09834.3	6,74



SERIE OVAL

Tête thermostatique - 108L



DÉSIGNATION	UT	CODE	PPHT (€)
450.0016.61 TETE THERMOSTATIQUE A BULBE OPTIMAX 108L	U	6143W.0	22,15

Le PPHT comprend l'ecopart (€)

ROBINET ET ACCESSOIRES RADIATEUR

ROBINET THERMOSTATIQUE



KIT THERMOSTATIQUE

CORPS + COUDE + TÊTE VT 0,4 - Femelle



DÉSIGNATION	UT	CODE	PPHT (€)
000.0034.90 KIT THERM.CORPS+COUD.1/2"+TETE TEKNIK 1115TE	U	309AS.8	34,90



ROBINET THERMOSTATIQUE

A plongeur vertical - Livrés sans tête



DÉSIGNATION	UT	CODE	PPHT (€)
653.0086.12 ROBINET A PLONGEUR VERT.BITUBE MUR.1/2 RTPMB	U	7391U.1	107,65

ROBINET THERMOSTATISABLE



ROBINET COMPLET

932 - Mono/bitube



DÉSIGNATION	UT	CODE	PPHT (€)
450.0044.80 ROBINET THERMO.MONO/BI 1/2"X18 T15 932	U	6375F.1	59,73



ROBINET POUR RADIATEURS TYPE SECHE SERVIETTE MONO-BITUBE

961P - Livré sans raccord - Avec tête manuelle



DÉSIGNATION	UT	CODE	PPHT (€)
450.0048.28 ROBINET THERMOSTATISABLE 1/2"X18 961P_1/2X	U	91358.2	64,38



ROBINET POUR RADIATEURS TYPE SECHE SERVIETTE MONO-BITUBE

962 - Livré sans raccord



DÉSIGNATION	UT	CODE	PPHT (€)
450.0030.71 ROBINET THERMOSTATISABLE 1/2"X18 962P_1/2X18	U	56135.7	40,95



ROBINET DROIT

A visser - 761R



DÉSIGNATION	UT	CODE	PPHT (€)
450.0011.04 ROBINET THERMOSTAT.DR. 1/2" 761R_15	U	4160E.7	14,72

ROBINET ET ACCESSOIRES RADIATEUR

ROBINET MANUEL



ROBINET SIMPLE REGLAGE
418U - Equerre à visser - EUROSAR



	DÉSIGNATION	UT	CODE	PPHT (€)	ECOPART (€)
451.0021.94	ROBINET EQU.SIMPLE REGL.EUROSAR 3/8" 418203	U	16022.6	27,44	0,02
451.0026.18	ROBINET EQU.SPL REGL.EUROSAR 1/2" 418204	U	16129.9	32,75	0,02
451.0035.46	ROBINET EQU.SPL REGL.EUROSAR 3/4" 418206	U	16159.6	44,35	0,02



ROBINET SIMPLE REGLAGE
419U - Droit à visser - EUROSAR



	DÉSIGNATION	UT	CODE	PPHT (€)	ECOPART (€)
451.0024.36	ROBINET DROIT SPL REGL.EUROSAR 3/8" 419203	U	18653.6	30,47	0,02
451.0028.81	ROBINET DROIT SPL REGL.EUROSAR 1/2" 419204	U	18655.1	36,03	0,02
451.0040.03	ROBINET DROIT SPL REGL.EUROSAR 3/4" 419206	U	18657.7	50,06	0,02



ROBINET SIMPLE REGLAGE
941 - Droit à visser



	DÉSIGNATION	UT	CODE	PPHT (€)
450.0012.77	ROBINET DROIT SIMPLE REGLAGE 1/2" 941_15	U	1111E.3	17,03



ROBINET SIMPLE REGLAGE
945 - Equerre à visser - Filetage joint à compression



	DÉSIGNATION	UT	CODE	PPHT (€)
450.0009.97	ROBINET EQUERRE SPLE REGLAGE 1/2X16 945_15X16	U	1113E.1	13,29

COUDE, TE DE REGLAGE, RACCORD ET DIVERS



RACCORD ET TE DE REGLAGE
3428 - Coude équerre à mémoire - A visser



	DÉSIGNATION	UT	CODE	PPHT (€)	ECOPART (€)
451.0015.43	COUDE DE REGLAGE EQ.A VISSER 3428 3/8 428303	U	15534.1	19,31	0,02
451.0018.58	COUDE DE REGLAGE EQ.A VISSER 3428 1/2 428304	U	37981.8	23,25	0,02
451.0027.71	COUDE DE REGLAGE EQ.A VISSER 3428 3/4 428306	U	15562.2	34,66	0,02

ROBINET ET ACCESSOIRES RADIATEUR

COUDE, TE DE REGLAGE, RACCORD ET DIVERS



RACCORD ET TE DE REGLAGE
3429 - Té Droit à mémoire - A visser



	DÉSIGNATION	UT	CODE	PPHT (€)	ECOPART (€)
451.0016.70	TE DE REGLAGE DR.A VISSER 3429 3/8 429303	U	47588.9	20,89	0,02
451.0020.66	TE DE REGLAGE DR.A VISSER 3429 1/2 429304	U	37837.2	25,85	0,02
451.0029.38	TE DE REGLAGE DR.A VISSER 3429 3/4 429306	U	15593.7	36,75	0,02



RACCORD 2000 / CORPS MONOPOINT
RA 15/6

Raccord à visser - PER



	DÉSIGNATION	UT	CODE	PPHT (€)
452.0005.06	RACCORD VISS.TUBE PER 16X1.5 F3/4 01364157	U	7443A.8	6,75



RACCORD POUR ROBINET MANUEL
Coude - Équerre - Joint fileté femelle - 755R



	DÉSIGNATION	UT	CODE	PPHT (€)
450.0007.35	COUDE DE REGLAGE JT.COMP.1/2X16 755R_15X16	U	1112H.6	9,80



RACCORD POUR ROBINET MANUEL
Té de réglage droite - Joint fileté mâle



	DÉSIGNATION	UT	CODE	PPHT (€)
450.0007.60	TE DE REGLAGE 1/2X16 756R_15X16	U	5437D.4	10,14



RACCORD POUR ROBINET COUDE ET TE SERIE MALE
3525N - Raccord pour tube Cuivre



	DÉSIGNATION	UT	CODE	PPHT (€)
450.0002.66	RACCORD NICKLE ALESAGE 16 P.CU14 3525N_16X14	U	30196.0	3,54
450.0002.66	RACCORD NICKLE ALESAGE 16 P.CU16 3525N_16X16	U	30198.6	3,54
450.0002.95	RACCORD NICKLE ALESAGE 18 CUIVRE 3525N_18X18	U	8948I.9	3,69

Le PPHT comprend l'ecopart (€)

ROBINET ET ACCESSOIRES RADIATEUR

COUDE, TE DE REGLAGE, RACCORD ET DIVERS



RACCORD POUR ROBINET COUDE ET TE SERIE MALE

3625N - Raccord pour tube Cuivre



	DÉSIGNATION	UT	CODE	PPHT (€)
450.0003.73	RACCORD NIQUELE ALESAGE 18 P.CU14 3625N_18X14	U	71682.9	4,97
450.0003.73	RACCORD NIQUELE ALESAGE 18 P.CU16 3625N_18X16	U	71684.5	4,97



RACCORD POUR ROBINET COUDE ET TE SERIE MALE

3015N - Raccord pour tube Réticulé



	DÉSIGNATION	UT	CODE	PPHT (€)
276.0004.42	RACCORD POUR TUBE P.E.R 3015N 16-13X16	U	83593.4	5,90
276.0004.50	RACCORD TUBE PER NIKELE 3015N_18X13X16	U	29082.5	6,00



RACCORD POUR ROBINETTERIE THERMOSTATIQUE

Ensembles thermostatiques bitube et monotube - Canne laiton chromé



	DÉSIGNATION	UT	CODE	PPHT (€)
653.0028.05	CANNE ACIER 15 L900 LAITON CHR. ZTA900	U	65976.3	37,40



RACCORD POUR ROBINETTERIE INTEGREE

Raccord pour vanne en H / Eurocône - Pour tube multicouche



	DÉSIGNATION	UT	CODE	PPHT (€)
653.0007.42	RACCORD EUROCONE 3/4 T.MC 10 3/4"X16 REC416	U	6666E.1	9,27

ACCESSOIRES RADIATEUR



VOLANT



	DÉSIGNATION	UT	CODE	PPHT (€)	ECOPART (€)
451.0005.94	VOLANT P.ROBINET RAD.516K+VIS KIT M540001001	U	37891.2	7,43	0,01

ROBINET ET ACCESSOIRES RADIATEUR

ACCESSOIRES RADIATEUR



MECANISME

Insert - Insert D



	DÉSIGNATION	UT	CODE	PPHT (€)
452.0015.13	INSERT D N1 SEUL P.RAD.TYPE D 01367370	U	34382.2	20,17



REPARTITEUR

RLV-KB - Arrivé par le mur



	DÉSIGNATION	UT	CODE	PPHT (€)
452.0014.02	REPARTITEUR RLV-KB 1/2 EQUERRE 003L0394	U	312PB.5	18,69



TUBE DE LIAISON

0914T - Chromé Long.95 cm



	DÉSIGNATION	UT	CODE	PPHT (€)
450.0010.41	TUBE DE LIAISON CHR 15MM/09.5M 0914T_15	U	72310.6	13,88



PURGEUR D'AIR AUTOMATIQUE

Purgeur d'air automatique - Avec Capuchon de protection



	DÉSIGNATION	UT	CODE	PPHT (€)
660.0023.84	PURGEUR D AIR AUTO VASA 1/2" RBM 370460	U	57635.5	31,78
660.0079.15	PURGEUR D AIR AUTO VASA 3/4" RBM 370570	U	43380.5	105,53



BOUCHON PURGEUR

BP - Nickelé - Fonction bouchon

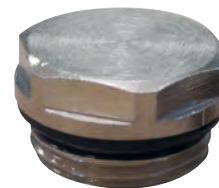

	DÉSIGNATION	UT	CODE	PPHT (€)
653.0001.34	BOUCHON PLEIN 1/2" BLISTER BPL15	U	70294.4	1,78



BOUCHON PURGEUR

BP - Nickelé - Fonction purgeur d'air



	DÉSIGNATION	UT	CODE	PPHT (€)
653.0001.84	BOUCHON PURGEUR BEC ORIENT. 1/2 VRAC BP15V	U	8407A.0	2,30

Le PPHT comprend l'ecopart (€)

ROBINET ET ACCESSOIRES RADIATEUR

ACCESSOIRES RADIATEUR



CLE

Clé pour purgeur à carré



	DÉSIGNATION	UT	CODE	PPHT (€)
653.0000.76	CLE PURGEUR A CARRÉ 4MM ZCLE4	U	81133.1	0,95
653.0000.76	CLE PURGEUR A CARRÉ 5MM ZCLE5	U	69734.2	0,95



PURGEUR AUTOMATIQUE

AERCAL - Avec bouchon hygroscopique - Modèle 1



	DÉSIGNATION	UT	CODE	PPHT (€)
653.0021.00	PURGEUR AERCAL RAD.COL.HORIZ.504401 1/2" PA15	U	46781.1	28,00



PURGEUR A DISQUES DE FIBRE

Boîte



	DÉSIGNATION	UT	CODE	PPHT (€)
653.0007.75	PURGEUR AUTOMAT.A DISQUES 508011 1/8" PD05	U	31401.3	9,69
653.0007.75	PURGEUR AUTOMAT.A DISQUES 508021 1/4" PD08	U	50826.7	9,69
653.0007.86	PURGEUR AUTOMAT.A DISQUES 508031 3/8" PD12	U	32048.1	9,82
653.0010.72	PURGEUR AUTOMAT.A DISQUES 508041 1/2" PD15	U	00950.6	13,40



PURGEUR MANUEL

PV - A volant - et à bec orientable



	DÉSIGNATION	UT	CODE	PPHT (€)
653.0001.84	PURGEUR A VOLANT BEC ORIENT.1/4" VRAC PV08BV	U	91098.7	1,84
653.0001.84	PURGEUR A VOLANT BEC ORIENT.1/8" VRAC PV05BV	U	29022.5	1,84

POMPE A CHALEUR

POMPE A CHALEUR



ALEZIO S V200 - SPLIT INVERTER ECS

Module hydraulique intérieur - MIV-S



	DÉSIGNATION	UT	CODE	PPHT (€)
565.2360.00	MODULE INT.MIV-S 4-8/EM EH730 ELEC. 7680455	U	269AJ.0	2950,00
565.2776.00	MODULE INT.MIV-S 11-16/EM EH731 ELEC. 7683499	U	268H8.8	3470,00
565.2776.00	MODULE INT.MIV-S 11-16/ET EH732 ELEC. 7683500	U	269B2.5	3470,00



ALEZIO AWHP-II - REVERSIBLE AIR/EAU - AEROTHERMIE

Module extérieur AWHP - Pour chauffage, rafraîchissement et climatisation



	DÉSIGNATION	UT	CODE	PPHT (€)	ECOPART (€)
565.2420.99	PAC ALEZIO AWHP 6 MR-3 EXT. EH672 7668016	U	9713P.9	3234,66	6,67
565.4731.19	PAC ALEZIO AWHP 11 MR-2 EXT. EH382 7609927	U	2623Q.1	5920,66	6,67
565.5094.39	PAC ALEZIO AWHP 11 TR-2 EXT. EH383 7609928	U	2623R.9	6374,66	6,67
565.7472.98	PAC ALEZIO AWHP 16 MR-2 EXT. EH384 7609929	U	2623S.7	7479,65	6,67
565.6465.57	PAC ALEZIO AWHP 16 TR-2 EXT. EH385 7609930	U	2623T.5	8088,63	6,67



ALEZIO AWHP-II - REVERSIBLE AIR/EAU - AEROTHERMIE

Module extérieur AWHP-II - Pour chauffage et rafraîchissement



	DÉSIGNATION	UT	CODE	PPHT (€)	ECOPART (€)
565.4326.00	PAC ALEZIO AWHP 8 MR-2 EXT. EH381 7609926	U	2623P.3	4332,67	6,67



PAC AIR-EAU POUR CHAUFFAGE ET ECS - ECODAN

Hydrobox - Chauffage Seul - Version Split - Unité extérieure - Rev.-Power Inverter



	DÉSIGNATION	UT	CODE	PPHT (€)	ECOPART (€)
580.3447.20	PAC.U.E.ECODAN 8KW 302361 PUHZ-SW75VAA	U	1747P.9	4315,67	6,67
580.5766.99	PAC.U.E.ECODAN 10KW 302415 PUHZ-SW100VAA	U	196L1.2	5773,66	6,67
580.3083.99	PAC.U.E.ECODAN 7.5KW 414783 SUZ-SWM80VA.TH	U	2411Z.9	3861,66	6,67
580.5001.59	PAC.U.E.ECODAN 10KW 414793 PUD-SWM100VAA	U	298JM.4	6258,66	6,67



PAC AIR/EAU - ECODAN ZUBADAN

Unité extérieure



	DÉSIGNATION	UT	CODE	PPHT (€)	ECOPART (€)
580.6161.98	PAC.U.E.ECODAN 12KW 580268 PUD-SHWM120VAAR1	U	313VX.4	8222,64	6,67

Le PPHT comprend l'ecopart (€)

POMPE A CHALEUR

POMPE A CHALEUR



PAC AIR/EAU - ECODAN ZUBADAN

Unité extérieure
- suite



DÉSIGNATION	UT	CODE	PPHT (€)	ECOPART (€)
580.8691.98 PAC.U.E.ECODAN 14KW 493637 PUD-SHWM140VAA	U	298JX.3	8698,65	6,67
580.11302.46 PAC.U.E.ECODAN 23KW 406667 PUHZ-SHW230YKA2R2	U	219X4.0	15076,61	6,67



GENIA AIR

PAC Air/Eau unité extérieure -
Monobloc



DÉSIGNATION	UT	CODE	PPHT (€)	ECOPART (€)
569.6613.48 PAC.U.E.AIR/EAU GENIA AIR 10 230V 0010021151	U	224VU.9	8824,65	6,67



GENIA AIR MAX

PAC Air/Eau Module hydraulique -unité intérieure



DÉSIGNATION	UT	CODE	PPHT (€)	ECOPART (€)
569.1874.99 PAC.U.I.MOD.HYDR.MUR.GENIA AIR MAX 0010023615	U	297RR.6	2500,41	0,42



GENIA AIR MAX

PAC Air/Eau unité extérieure



DÉSIGNATION	UT	CODE	PPHT (€)	ECOPART (€)
569.7294.47 PAC.U.E.AIR/EAU GENIA AIR MAX 8 M 0010031695	U	298P6.7	9732,63	6,67
569.8766.72 PAC.U.E.AIR/EAU GENIA AIR MAX 12 M 0010031696	U	298P8.3	11695,63	6,67
569.9297.71 PAC.U.E.AIR/EAU GENIA AIR MAX 15 M 0010031698	U	288W4.6	12403,62	6,67
569.9590.98 PAC.U.E.AIR/EAU GENIA AIR MAX 15 T 0010031699	U	282N5.9	12794,64	6,67



GENIA AIR SPLIT

PAC Air/Eau unité extérieure - Bi-bloc



DÉSIGNATION	UT	CODE	PPHT (€)	ECOPART (€)
569.5057.99 PAC.U.E.AIR/EAU GENIAAIR SPLT 7 M 0010021150	U	197ZB.0	6750,66	6,67
569.6969.73 PAC.U.E.AIR/EAU GENIAAIR SPLT 10 T 0010021152	U	219NL.8	9299,64	6,67
569.7418.98 PAC.U.E.AIR/EAU GENIAAIR SPLT 12 M 0010021153	U	223T4.6	9898,64	6,67
569.7816.48 PAC.U.E.AIR/EAU GENIAAIR SPLT 12 T 0010021154	U	310KC.6	10428,65	6,67

Le PPHT comprend l'ecopart (€)

POMPE A CHALEUR

POMPE A CHALEUR



GENIA AIR SPLIT

PAC Air/Eau Module hydraulique -unité intérieure



DÉSIGNATION	UT	CODE	PPHT (€)	ECOPART (€)
569.2102.24 PAC.U.I.MOD.HYDR.MUR.SPLIT 7 0010023497	U	271VC.5	2803,41	0,42
569.2338.49 PAC.U.I.MOD.HYDR.MUR.SPLIT 10/12 0010023527	U	317FM.6	3118,41	0,42



GENIA SET SPLIT

PAC Air/Eau unité intérieure - Bi-bloc double service



DÉSIGNATION	UT	CODE	PPHT (€)	ECOPART (€)
569.3490.49 PAC.U.I.AIR/EAU GENIASET SPLT 7 0010023172	U	197ZC.8	4658,99	5,00
569.3613.49 PAC.U.I.AIR/EAU GENIASET SPLT10/12 0010023173	U	223T6.1	4822,99	5,00



GENIA SET MAX

PAC Air/Eau unité intérieure - Genia Set pour Genia Air Max



DÉSIGNATION	UT	CODE	PPHT (€)	ECOPART (€)
569.3038.24 PAC.U.I.+ECS GENIASET MAX 230V 0010036670	U	288WA.2	4055,99	5,00

ACCESSOIRES POMPE A CHALEUR



APPOINT ELECTRIQUE

Kit



DÉSIGNATION	UT	CODE	PPHT (€)	ECOPART (€)
564.0033.60 KIT RELAIS APPOINT 6KW 075327	U	9205P.4	42,12	0,12



REGULATION

Kit de rafraîchissement



DÉSIGNATION	UT	CODE	PPHT (€)	ECOPART (€)
000.0126.00 KIT RAFRAICHISSEMENT PAC. DUO A.I.R32 075329	U	266FQ.9	168,12	0,12

POMPE A CHALEUR

ACCESSOIRES POMPE A CHALEUR



ACCESSOIRES POMPE A CHALEUR

Condensat



DÉSIGNATION	UT	CODE	PPHT (€)	ECOPART (€)
RACCORD ADAPTATION FRIGO EH146 100015480	U	6726C.4	88,88	0,88



KIT DE RACCORDEMENT

GeniaSet PAC Air/Eau



DÉSIGNATION	UT	CODE	PPHT (€)
KIT RACCORD.GENIASET PAC AIR/EAU 0020221268	U	8958S.9	201,00



INTERFACE M-NET



DÉSIGNATION	UT	CODE	PPHT (€)
INTERFACE M-NET ADAPTER 404755 MAC-334IF-E	U	240UE.6	291,00



MODULE HYDRAULIQUE ET RACCORD

Module hydraulique - ECODAN - Split Réversible - Triphasé



DÉSIGNATION	UT	CODE	PPHT (€)	ECOPART (€)
MODULE HYDR.ECODAN E 9KW T 471686 ERSE-YM9ED	U	301W7.0	6647,33	8,33



MODULE HYDRAULIQUE ET RACCORD

Module hydraulique - ECODAN - Pour Hydrobox R - Version Split



DÉSIGNATION	UT	CODE	PPHT (€)	ECOPART (€)
MODULE HYDR.ECODAN D 6KW M 502170 ERSD-VM6D	U	301W0.5	4318,31	8,33
MODULE HYDR.DUO 200L 502175 ERST20D-VM6DR1	U	298JZ.0	7510,31	8,33
MODULE HYDR.DUO 200L 502177 ERST20C-VM6DR1	U	298K1.7	8510,31	8,33
MODULE HYDR.DUO 200L 502176 ERST20D-YM9DR1	U	298K0.9	8105,31	8,33

POMPE A CHALEUR

ACCESSOIRES POMPE A CHALEUR



MODULE HYDRAULIQUE ET RACCORD

Kit hydraulique/raccordement - Kit de raccordement



DÉSIGNATION	UT	CODE	PPHT (€)
KIT CONNEX.ECS HYDROBOX5DUO 255485 PAC-ISOECS	U	0737N.2	240,00
KIT RACC.HYDROBOX5/11ECODAN 255487 PAC-ISOCH	U	3752T.6	105,00



SONDE DE TEMPERATURE

Pour Hydrobox - Ecodan - ECS



DÉSIGNATION	UT	CODE	PPHT (€)
SONDE TEMP.ECS ECODAN 484850 PAC-TH011TK2-E	U	279AM.3	46,00



SONDE DE TEMPERATURE

Pour Hydrobox - Ecodan



DÉSIGNATION	UT	CODE	PPHT (€)
SONDE TEMP.X2 ECODAN 256767 PAC-TH011-E	U	0736Y.2	66,00



TELECOMMANDE

Sans fil - Emetteur



DÉSIGNATION	UT	CODE	PPHT (€)	ECOPART (€)
TELECOMMANDE SS FIL ECODAN 254308 PAR-WT50R-E	U	9209G.5	174,02	0,02



TELECOMMANDE

Sans fil - Récepteur



DÉSIGNATION	UT	CODE	PPHT (€)
RECEPTEUR SS.FIL HYDROBOX 254310 PAR-WR51R-E	U	9210A.5	136,00

Le PPHT comprend l'ecopart (€)

STOCKAGE FIOUL ET ACCESSOIRES

ACCESSOIRES FIOUL



FILTRATION FIOUL

Filtre - Monotube avec dégazage automatique



	DÉSIGNATION	UT	CODE	PPHT (€)	ECOPART (€)
650.0069.20	FILTRE FIOUL DESAERATEUR FLOCCOTOP-1K 70135	U	7620R.1	92,27	
650.0103.35	FILTRE FIOUL DESAERATEUR FLOCCOTOP-1C SI 70155	U	37703.5	103,36	0,01



EQUIPEMENT FIOUL-CITERNE-BRULEUR

Plongeur fioul - Euroflex



	DÉSIGNATION	UT	CODE	PPHT (€)	ECOPART (€)
650.0050.75	ENSEMBLE ASPIR.EUROFLEX 3M 2M10 2410301	U	15543.2	67,68	0,01

100% EXPO



Faites de nos salles Expo
vos outils de vente

Le PPHT comprend l'ecopart (€)

Les tarifs et disponibilités de nos produits peuvent évoluer sans préavis

PIECES DE RECHANGE CHAUFFE-EAU

CHAUFFE-EAU



RESISTANCE

Résistance stéatite - Tri



	DÉSIGNATION	UT	CODE	PPHT (€)
015.0068.10	RESISTANCE STEATITE 1800W 230V/400V 060178	U	80720.4	68,10



THERMOSTAT

A canne - Embrochable - Type TSE



	DÉSIGNATION	UT	CODE	PPHT (€)
015.0053.12	THERMOSTAT A CANNE L6270 070070	U	33601.9	53,12
015.0045.15	THERMOSTAT MONO EMBROCHABLE HM ATL. 099045	U	6742A.8	53,12
015.0057.75	THERMOSTAT EMB.MONO VM/VS ATL. 099043	U	28088.3	67,94



THERMOSTAT

Tus00316 vert L450 s95



	DÉSIGNATION	UT	CODE	PPHT (€)
015.0054.17	THERMOSTAT TUS00316 VERT L450 R64 S95 029990	U	326AB.4	54,17

BÂTI-SUPPORTS DUOFIX ET WC GEBERIT

BÂTIS POUR DURER

**KNOW
HOW
INSTALLED***

*LE SAVOIR-FAIRE INTÉGRÉ

**NOUVELLES
GARANTIES**



50 DISPONIBILITÉ DES
PIÈCES DÉTACHÉES
GARANTIE 50 ANS**

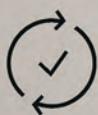

CÉRAMIQUE GEBERIT,
GARANTIE À VIE



FACILITÉ D'INSTALLATION
AVEC LES FIXATIONS EFF3



WC SANS BRIDE
RIMFREE®



Retrouvez ici la
liste des produits
en céramique
Geberit garantis
à vie.

www.geberit.fr

| 196 |

J+0 100% Dispo www.richardson.fr

** Sur réservoir de bâti-support
WC après arrêt de production.



Sanitaire - Cuisine

SOMMAIRE

MEUBLE ET PLAN DE SALLE DE BAINS

MEUBLE DE SALLE DE BAINS	198
PLAN-VASQUE	199
MIROIR	200
ARMOIRE DE TOILETTE	201

LAVABO, LAVE-MAINS, VASQUE

LAVABO/COLONNE	201
VASQUE	202
LAVE-MAINS	202
ROBINETTERIE DE LAVABO/LAVE-MAINS	203
VIDAGE/SIPHON DE LAVABO/LAVE-MAINS	205

DOUCHE

RECEVEUR A ENCASTRER	209
RECEVEUR SURELEVE, A POSER	210
RECEVEUR A CARRELER	211
PAROI ET PORTE DE DOUCHE	215
ROBINETTERIE DE DOUCHE	216
ROBINETTERIE ENCASTREE DE DOUCHE	218
VIDAGE ET SIPHON DE DOUCHE	219
ACCESSOIRES DE DOUCHE	221

HYDROTHERAPIE

COLONNE DE DOUCHE	222
BARRE DE DOUCHE	223
DOUCHETTE	225
FLEXIBLE DE DOUCHE	227
ACCESSOIRES ET SUPPORTS DE DOUCHE	228

BAIGNOIRE

BAIGNOIRE EN MATERIAU DE SYNTHESE	228
BAIGNOIRE ACRYLIQUE	229
BAIGNOIRE ACIER	229
TABLIER DE BAIGNOIRE	230
PARE BAIGNOIRE	230
ROBINETTERIE BAIN / DOUCHE	230
VIDAGE/SIPHON DE BAIGNOIRE	233
ACCESSOIRES DE BAIGNOIRE	234

ACCESSOIRES DE SALLE DE BAINS

GAMME CONFORT	234
GAMME ECONOMIQUE	235

WC

BATI SUPPORT WC	236
PACK WC SUSPENDU	238
WC SUSPENDU	240
PACK WC SUR PIED	240
WC SUR PIED	241
RESERVOIR WC	242
MECANISME WC ET ROBINET DE CHASSE	243
ABATTANT WC	245
ACCESSOIRES WC	246
BROYEUR WC	246
ROBINETTERIE HYGIENIQUE	247

BIDET

BATI-SUPPORT BIDET	248
ROBINETTERIE DE BIDET	248
VIDAGE ET SIPHON DE BIDET	249

EVIER, MEUBLE CUISINE, KITCHENETTE

EVIER INOX	249
EVIER DE SYNTHESE	250
EVIER CERAMIQUE	250
MEUBLE SOUS EVIER	251
ROBINETTERIE CUISINE	252
VIDAGE ET SIPHON CUISINE	255

COLLECTIVITE POINT D'EAU

VASQUE, LAVABO ET LAVE-MAINS	257
------------------------------	-----

VIDOIR ET DEVERSOIR	257
ROBINETTERIE COLLECTIVITE POINT D'EAU	258
ACCESSOIRES COLLECTIVITE POINT D'EAU	261

COLLECTIVITE DOUCHE

ROBINETTERIE COLLECTIVITE DOUCHE	262
ACCESSOIRES COLLECTIVITE DOUCHE	263

COLLECTIVITE BAIN

ROBINETTERIE COLLECTIVITE BAIN	263
--------------------------------	-----

COLLECTIVITE ESPACE TOILETTES

WC SUSPENDU COLLECTIVITE	264
WC AU SOL COLLECTIVITE	264
URINOIR, STALLE ET SIEGE A LA TURQUE	264
ROBINETTERIE COLLECTIVITE ESPACE TOILETTES	265

COLLECTIVITE CUISINE

EVIER, PLONGE ET TIMBRE OFFICE	266
ROBINETTERIE COLLECTIVITE CUISINE	266

ACCESSIBILITE POINT D'EAU

PLAN, LAVABO, LAVE-MAINS ACCESSIBILITE	267
--	-----

ACCESSIBILITE DOUCHE

ACCESSOIRES ACCESSIBILITE DOUCHE	268
----------------------------------	-----

ACCESSIBILITE ESPACE TOILETTES

WC SUSPENDU ACCESSIBILITE	268
PACK WC SUR PIED ACCESSIBILITE	268
ACCESSOIRES ACCESSIBILITE ESPACE TOILETTES	268

PIECES DE RECHANGE SANITAIRE

BAIGNOIRE	269
ROBINETTERIE	269
TOILETTES / WC	271

100% Exclusivités Robinetterie

eazy
par **NOBILIA**



Pro

Metropolitan
par **NOBILIA**



Essentiel

UPcity
par **NOBILIA**



Tendance

Sign
par **fimal**



Design

Les gammes exclusives,
Le meilleur atout des Pros

- Des prix publics attractifs
- La qualité des grandes marques
- Produits et pièces détachées disponibles rapidement

Retrouvez tous les produits
exclusifs dans nos catalogues !



RICHARDSON

MEUBLE ET PLAN DE SALLE DE BAINS

MEUBLE DE SALLE DE BAINS

eazy
Collections
Exclusives

EXCLUSIVITES RICHARDSON PAR GBGROUP

Meuble sous-vasque - 2 portes - fermeture douce et silencieuse - Pieds inclus



	DÉSIGNATION	UT	CODE	PPHT (€)	ECOPART (€)
592.0155.12	MEUBLE+PIEDS 2P.60CM BOIS EAZY GB RC0011-L	U	3632X.3	195,57	1,67
592.0155.12	MEUBLE+PIEDS 2P.60CM BLC EAZY GB RC0011-B	U	3632T.2	195,57	1,67
592.0155.12	MEUBLE+PIEDS 2P.60 GRIS ANT. EAZY GB RC0011-G	U	9919S.5	195,57	1,67
592.0159.12	MEUBLE+PIEDS 2P.70CM BLC EAZY GB RC0012-B	U	3818S.0	200,57	1,67
592.0159.12	MEUBLE+PIEDS 2P.70CM BOIS EAZY GB RC0012-L	U	3818T.8	200,57	1,67
592.0159.12	MEUBLE+PIEDS 2P.70 GRIS ANT. EAZY GB RC0012-G	U	9921R.3	200,57	1,67
592.0183.60	MEUBLE+PIEDS 2P.80CM BLC EAZY GB RC0013-B	U	3824S.7	231,17	1,67

eazy
Collections
Exclusives

EXCLUSIVITES RICHARDSON PAR GBGROUP

Meuble sous-vasque - 2 tiroirs - fermeture douce et silencieuse - Pieds inclus

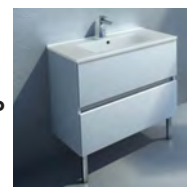

	DÉSIGNATION	UT	CODE	PPHT (€)	ECOPART (€)
592.0207.36	MEUBLE+PIEDS 2T.60CM BLC EAZY GB RC0014-B	U	3822C.4	260,87	1,67
592.0210.88	MEUBLE+PIEDS 2T.70CM BLC EAZY GB RC0015-B	U	3824L.4	265,27	1,67
592.0207.36	MEUBLE+PIEDS 2T.60CM BOIS EAZY GB RC0014-L	U	3823B.5	260,87	1,67
592.0237.28	MEUBLE+PIEDS 2T.80CM BLC EAZY GB RC0016-B	U	3826J.6	298,27	1,67

Metropolitan
Collections
Exclusives

EXCLUSIVITES RICHARDSON PAR GBGROUP

Meuble haut - Niche

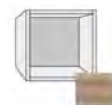

	DÉSIGNATION	UT	CODE	PPHT (€)	ECOPART (€)
748.0116.66	MEUBLE HAUT METRO.35X35 NICHE BOIS/VIN ELE011	U	201CS.5	146,30	0,47

Metropolitan
Collections
Exclusives

EXCLUSIVITES RICHARDSON PAR GBGROUP

Meuble lave-mains



	DÉSIGNATION	UT	CODE	PPHT (€)	ECOPART (€)
748.0111.33	MEUBLE L/M S/PL METRO.1P.40 BOIS/CH/N BLO008	U	201CE.0	140,24	1,08
748.0111.33	MEUBLE L/M S/PL METRO.1P.40CM BLC BLO006	U	201CC.5	140,24	1,08
748.0111.33	MEUBLE L/M S/PL METRO.1P.40 BOIS/VIN BLO010	U	201CG.6	140,24	1,08
748.0111.33	MEUBLE L/M S/PL METRO.1P.40CM ANTHRA.BLO007	U	201CD.3	140,24	1,08
748.0111.33	MEUBLE L/M S/PL METRO.1P.40 BOIS/CH/F BLO009	U	201CF.8	140,24	1,08

Le PPHT comprend l'ecopart (€)

MEUBLE ET PLAN DE SALLE DE BAINS

MEUBLE DE SALLE DE BAINS

Metropolitan
Collections Exclusives
EXCLUSIVITES RICHARDSON PAR GBGROUP

Meuble sous plan - 2 tiroirs



	DÉSIGNATION	UT	CODE	PPHT (€)	ECOPART (€)
748.0241.53	MEUBLE S/PL METRO.2TR.60CM BOIS/CH.N RC0047	U	200XP.8	303,58	1,67
748.0241.53	MEUBLE S/PL METRO.2TR. 60CM BLC/BR RC0037	U	200XB.4	303,58	1,67
748.0241.53	MEUBLE S/PL METRO.2TR.60CM BOIS VIN. RC0057	U	200Y0.7	303,58	1,67
748.0241.53	MEUBLE S/PL METRO.2TR. 60CM ANTHRA. RC0042	U	200XG.3	303,58	1,67
748.0309.60	MEUBLE S/PL METRO.2TR. 70CM BLC/BR RC0038	U	200XC.2	388,67	1,67
748.0309.60	MEUBLE S/PL METRO.2TR.70CM BOIS/VIN. RC0058	U	200Y2.3	388,67	1,67
748.0309.60	MEUBLE S/PL METRO.2TR.70CM BOIS/CH.N RC0048	U	200XQ.6	388,67	1,67
748.0332.66	MEUBLE S/PL METRO.2TR. 80CM BLC/BR RC0039	U	200XD.0	417,50	1,67
748.0332.66	MEUBLE S/PL METRO.2TR.80CM BOIS/VIN. RC0059	U	200Y3.1	417,50	1,67
748.0332.66	MEUBLE S/PL METRO.2TR. 80CM ANTHRA. RC0044	U	200XJ.8	417,50	1,67
748.0332.66	MEUBLE S/PL METRO.2TR.80CM BOIS/CH.N RC0049	U	200XR.4	417,50	1,67
748.0332.66	MEUBLE S/PL METRO.2TR.80CM BOIS/CH.F RC0054	U	200XX.1	417,50	1,67
748.0346.60	MEUBLE S/PL METRO.2TR. 90CM BLC/BR RC0040	U	200XE.7	435,58	2,33
748.0346.60	MEUBLE S/PL METRO.2TR.90CM BOIS/VIN. RC0060	U	200Y4.9	435,58	2,33
748.0346.60	MEUBLE S/PL METRO.2TR. 90CM ANTHRA. RC0045	U	200XK.6	435,58	2,33
748.0346.60	MEUBLE S/PL METRO.2TR.90CM BOIS/CH.N RC0050	U	200XS.2	435,58	2,33
748.0346.60	MEUBLE S/PL METRO.2TR.90CM BOIS/CH.F RC0055	U	200XY.9	435,58	2,33
748.0399.93	MEUBLE S/PL METRO.2TR.120CM BOIS/VIN. RC0061	U	200Y5.6	502,24	2,33
748.0399.93	MEUBLE S/PL METRO.2TR.120CM BOIS/CH.N RC0051	U	200XT.0	502,24	2,33

Metropolitan
Collections Exclusives
EXCLUSIVITES RICHARDSON PAR GBGROUP

Poignées meubles



	DÉSIGNATION	UT	CODE	PPHT (€)	ECOPART (€)
748.0013.46	POIGNEE METROPOLITAN 20CM NOIR/MAT G65.200N	U	200Y6.4	16,85	0,02
748.0016.13	POIGNEE METROPOLITAN 40CM NOIR/MAT G65.400N	U	200Y7.2	20,18	0,02
748.0013.46	POIGNEE METROPOLITAN 20CM CHR G65.200C	U	200Y8.0	16,85	0,02
748.0016.13	POIGNEE METROPOLITAN 40CM CHR G65.400C	U	200Y9.8	20,18	0,02

Metropolitan
Collections Exclusives
EXCLUSIVITES RICHARDSON PAR GBGROUP

Poignée porte-serviettes



	DÉSIGNATION	UT	CODE	PPHT (€)	ECOPART (€)
748.0014.46	POIGNEE PORTE-SERV. METRO.33CM CHR G67.C	U	2016Z.8	18,13	0,05
748.0014.46	POIGNEE PORTE-SERV. METRO.33CM NOIR/MAT G67.N	U	2017Z.7	18,13	0,05

MEUBLE ET PLAN DE SALLE DE BAINS

MEUBLE DE SALLE DE BAINS

Metropolitan
Collections Exclusives
EXCLUSIVITES RICHARDSON PAR GBGROUP

Poignée porte-serviettes - Porte-serviettes



	DÉSIGNATION	UT	CODE	PPHT (€)	ECOPART (€)
748.0071.93	PORTE-SERVIETTE METROPOLITAN CHR XC941	U	201A0.3	89,96	0,05
748.0080.60	PORTE-SERVIETTE METROPOLITAN NOIR/MAT XC942	U	201A1.1	100,80	0,05

Metropolitan
Collections Exclusives
EXCLUSIVITES RICHARDSON PAR GBGROUP

Pieds



	DÉSIGNATION	UT	CODE	PPHT (€)	ECOPART (€)
748.0024.40	PIEDS METROPOLITAN 33CM PAIRE CHR XA98Z	U	2018Z.6	30,55	0,05
748.0036.33	PIEDS METROPOLITAN 33CM PAIRE NOIR/MAT XA983	U	2019Z.5	45,46	0,05

PLAN-VASQUE

eazy
Collections Exclusives



EXCLUSIVITES RICHARDSON PAR GBGROUP
Plan vasque céramique - Simple vasque



	DÉSIGNATION	UT	CODE	PPHT (€)	ECOPART (€)
592.0100.40	PLAN CERAMIQ.60CM 1VASQ.BLC BR. EAZY GB TK010	U	3775X.0	128,42	2,92
592.0129.84	PLAN CERAMIQ.70CM 1VASQ.BLC BRL.EAZY GB TK011	U	3818U.5	165,22	2,92
592.0150.40	PLAN CERAMIQ.80CM 1VASQ.BLC BR. EAZY GB TK012	U	3824J.8	190,92	2,92

eazy
Collections Exclusives



EXCLUSIVITES RICHARDSON PAR GBGROUP
Plan vasque céramique - Double vasque



	DÉSIGNATION	UT	CODE	PPHT (€)	ECOPART (€)
592.0400.72	PLAN CERAMIQ.120CM 2VASQ.BLC BR.EAZY GB TK013	U	3825J.7	506,48	5,58

Metropolitan
Collections Exclusives

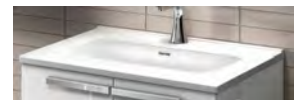

EXCLUSIVITES RICHARDSON PAR GBGROUP
Plan céramique - Simple vasque



	DÉSIGNATION	UT	CODE	PPHT (€)	ECOPART (€)
748.0110.00	PLAN CERAM. METROPOLITAN SPL/VASQ.61CM TK014	U	200ZK.4	140,42	2,92
748.0138.60	PLAN CERAM. METROPOLITAN SPL/VASQ.71CM TK015	U	201C1.9	176,17	2,92
748.0155.93	PLAN CERAM. METROPOLITAN SPL/VASQ.81CM TK016	U	201C7.6	197,83	2,92

Le PPHT comprend l'ecopart (€)

Les tarifs et disponibilités de nos produits peuvent évoluer sans préavis

RICHARDSON

199

MEUBLE ET PLAN DE SALLE DE BAINS

PLAN-VASQUE

Metropolitan



EXCLUSIVITES RICHARDSON PAR GBGROUP

Plan céramique - Simple vasque
- suite



	DÉSIGNATION	UT	CODE	PPHT (€)	ECOPART (€)
748.0173.00	PLAN CERAM. METROPOLITAN SPL/VASQ.91CM TK017	U	201C8.4	219,17	2,92
748.0339.26	PLAN CERAM. METROPOLITAN SPL/VASQ.121CM TK018	U	201C9.2	428,00	3,92

Metropolitan



EXCLUSIVITES RICHARDSON PAR GBGROUP

Plan céramique - Double vasque



	DÉSIGNATION	UT	CODE	PPHT (€)	ECOPART (€)
748.0365.00	PLAN CERAM. METROPOLITAN DBL/VASQ.121CM TK019	U	201CA.9	461,83	5,58

MIROIR

eazy



EXCLUSIVITES RICHARDSON PAR GB GROUP

Applique LED



	DÉSIGNATION	UT	CODE	PPHT (€)	ECOPART (€)
592.0020.32	APPLIQUE LED EAZY GB H62	U	294X5.0	25,50	0,10

eazy



EXCLUSIVITES RICHARDSON PAR GB GROUP

Miroir - Miroir crédence



	DÉSIGNATION	UT	CODE	PPHT (€)	ECOPART (€)
592.0062.80	MIROIR CRED.TTE HAUT. 60X108CM EAZY GB SF993	U	3830W.5	79,60	1,10
592.0072.16	MIROIR CRED.TTE HAUT. 70X108CM EAZY GB SF994	U	38318.2	91,30	1,10
592.0077.60	MIROIR CRED.TTE HAUT. 80X108CM EAZY GB SF995	U	38319.0	98,10	1,10
592.0100.72	MIROIR CRED.TTE HAUT.120X108CM EAZY GB SF996	U	3831L.5	127,00	1,10

MEUBLE ET PLAN DE SALLE DE BAINS

MIROIR

eazy

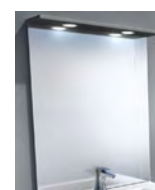

EXCLUSIVITES RICHARDSON PAR GB GROUP

Miroir - Miroir décor



	DÉSIGNATION	UT	CODE	PPHT (€)	ECOPART (€)
592.0053.68	MIROIR L60XH70CM EAZY SF989	U	3775W.2	68,20	1,10
592.0058.80	MIROIR L70XH70CM EAZY SF990	U	3820Y.3	74,60	1,10
592.0063.76	MIROIR L80XH70CM EAZY SF991	U	3824N.0	80,80	1,10
592.0083.92	MIROIR L120XH70CM EAZY SF992	U	3825T.9	106,00	1,10

eazy

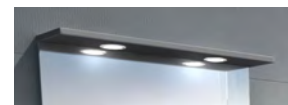

EXCLUSIVITES RICHARDSON PAR GB GROUP

Bandeau - Bandeau en mélaminé et éclairage LED classe II IP44



	DÉSIGNATION	UT	CODE	PPHT (€)	ECOPART (€)
592.0060.56	BANDEAU SPOT LED IP44 60CM BLC EAZY GB MEOH10	U	3831T.1	75,90	0,20
592.0065.52	BANDEAU SPOT LED IP44 80CM BLC EAZY GB MEOH12	U	3832S.2	82,10	0,20
592.0083.76	BANDEAU SPOT LED IP44 120CM BLC EAZY MEOH13	U	3834L.4	105,00	0,30

Metropolitan

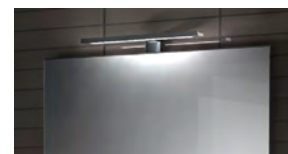

EXCLUSIVITES RICHARDSON PAR GBGROUP

Applique



	DÉSIGNATION	UT	CODE	PPHT (€)	ECOPART (€)
748.0048.33	APPLIQUE LED METROPOLITAN 30CM CHR H59.300C	U	201BV.9	60,51	0,10
748.0056.33	APPLIQUE LED METROPOLITAN 50CM CHR H59.500C	U	201BX.5	70,51	0,10
748.0048.33	APPLIQUE LED METROPOLITAN 30C NOIR/M H59.300N	U	201BY.3	60,51	0,10
748.0056.33	APPLIQUE LED METROPOLITAN 50C NOIR/M H59.500N	U	201BZ.2	70,51	0,10

Metropolitan

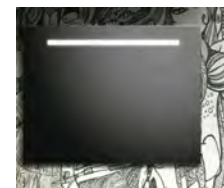

EXCLUSIVITES RICHARDSON PAR GBGROUP

Miroir - Rétro-éclairage LED



	DÉSIGNATION	UT	CODE	PPHT (€)	ECOPART (€)
748.0199.33	MIROIR LED METROPOLITAN 60CM SR979	U	201BJ.2	250,47	1,31
748.0207.26	MIROIR LED METROPOLITAN 70CM SR980	U	201BK.0	260,39	1,31
748.0215.26	MIROIR LED METROPOLITAN 80CM SR981	U	201BM.6	270,39	1,31
748.0232.33	MIROIR LED METROPOLITAN 90CM SR982	U	201BQ.0	291,72	1,31
748.0316.00	MIROIR LED METROPOLITAN 120CM SR983	U	201BS.6	397,31	2,31

Le PPHT comprend l'ecopart (€)

MEUBLE ET PLAN DE SALLE DE BAINS

MIROIR

Metropolitan



EXCLUSIVITES RICHARDSON PAR GBGROUP

Miroir - Chants métal chromés



	DÉSIGNATION	UT	CODE	PPHT (€)	ECOPART (€)
748.0057.46	MIROIR METROPOLITAN 35X70CM SF954	U	201A3.7	72,84	1,01
748.0124.13	MIROIR METROPOLITAN 60X70CM SF955	U	201A4.5	156,26	1,10
748.0137.93	MIROIR METROPOLITAN 80X70CM SF957	U	201A6.0	173,51	1,10
748.0140.60	MIROIR METROPOLITAN 90X70CM SF958	U	201A7.8	176,85	1,10
748.0206.60	MIROIR METROPOLITAN 120X70CM SF959	U	201A8.6	259,35	1,10

ARMOIRE DE TOILETTE

Metropolitan



EXCLUSIVITES RICHARDSON PAR GBGROUP

Armoire toilette, portes miroir asymétriques - 2 étagères en verre et prise électrique à l'intérieur



	DÉSIGNATION	UT	CODE	PPHT (€)	ECOPART (€)
748.0225.06	ARMOIRE TOIL.METRO.PASYM.60CMBOIS/CH.N SC902	U	201AK.1	283,43	2,10
748.0225.06	ARMOIRE TOIL.METRO.PASYM.60CM BOIS/VIN SC904	U	201BD.4	283,43	2,10
748.0322.06	ARMOIRE TOIL.METRO.PASYM.90CM ANTHRA. SC916	U	201AH.6	404,68	2,10

Metropolitan



EXCLUSIVITES RICHARDSON PAR GBGROUP

Poignées armoires de toilette

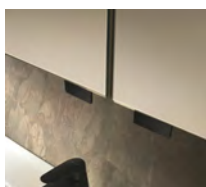

	DÉSIGNATION	UT	CODE	PPHT (€)	ECOPART (€)
748.0018.40	KIT POIGNEES ARMOIRE METROPOL. NOIR/MAT G66.N	U	2015Z.9	23,02	0,02
748.0018.40	KIT POIGNEES ARMOIRE METROPOLITAN CHR G66.C	U	200ZZ.6	23,02	0,02

Pour plus d'infos,
consultez
le CAHIER TECHNIQUE
page 14

Le PPHT comprend l'ecopart (€)

LAVABO, LAVE-MAINS, VASQUE

LAVABO/COLONNE

Jacob Delafon

BRIVE

Lavabo - autoportant. Percé 1 trou



	DÉSIGNATION	UT	CODE	PPHT (€)	ECOPART (€)
704.0046.68	LAVABO BRIVE 50CM BLC JD E1345F-00	U	1116W.4	58,41	0,06

Jacob Delafon

BRIVE 2

Lavabo avec dossier arrière pour protéger des projections d'eau - 1 trou percé 2 trous amorcés



	DÉSIGNATION	UT	CODE	PPHT (€)	ECOPART (€)
527.0045.00	LAVABO BRIVE 2 60X48 BLC JD E1286-00	U	10960.3	56,31	0,06
704.0044.84	LAVABO BRIVE 2 55X46 BLC JD E1282F-00	U	9136H.1	56,11	0,06

Jacob Delafon

BRIVE 2

Colonne



	DÉSIGNATION	UT	CODE	PPHT (€)	ECOPART (€)
704.0034.44	COLONNE BRIVE 2 67,5X35 BLC JD E4444-00	U	26610.6	43,11	0,06

Vitra

CONFORMA

Lavabo PMR - Trou de robinetterie, sans trop-plein



	DÉSIGNATION	UT	CODE	PPHT (€)	ECOPART (€)
000.0152.80	LAVABO S20 PMR 65CM SS.T-PLEIN 5291B003-0041	U	2937M.8	191,06	0,06

Vitra

INTEGRA

Colonne pour lavabo - Colonne



	DÉSIGNATION	UT	CODE	PPHT (€)	ECOPART (€)
000.0048.00	COLONNE INTEGRA LAV-L/M 66X18 6936L003-7035	U	2461M.2	60,06	0,06

Vitra

NORMUS

Lavabo - 1 trou central pour robinet, avec trop-plein



	DÉSIGNATION	UT	CODE	PPHT (€)	ECOPART (€)
000.0050.40	LAVABO ARKITEKT NORMUS 60 BLANC 5088L003-1029	U	97950.8	63,06	0,06

LAVABO, LAVE-MAINS, VASQUE

LAVABO/COLONNE

Vittra

NUO

Lavabo



	DÉSIGNATION	UT	CODE	PPHT (€)	ECOPART (€)
000.0304.00	LAVABO NUO 50CM 7431B003-0631	U	27906.6	380,06	0,06
000.0388.80	LAVABO NUO 60X44CM RECT BLC 7432B003-0631	U	313A7.1	486,06	0,06
000.0265.60	LAVABO NUO 50X38 RECT. BLANC 7436B003-0012	U	313AH.9	332,15	0,15
000.0277.60	LAVABO NUO 60X38 RECT. BLANC 7434B003-0012	U	313AK.4	347,15	0,15

VASQUE

Jacob Delafon
PARIS

ODEON UP

Vasque à encastrer par-dessus -
Monotrou



	DÉSIGNATION	UT	CODE	PPHT (€)	ECOPART (€)
527.0174.32	VASQUE ODEON UP A/ENC. 56X44 BLC JD E4756-00	U	53312.5	218,05	0,15

Jacob Delafon
PARIS

PATIO

Vasque à encastrer par-dessus -
Percée 1 trou, prépercée 2 trous



	DÉSIGNATION	UT	CODE	PPHT (€)	ECOPART (€)
527.0055.64	VASQUE PATIO/ODEON A/ENC. 56X43 BLC E4155-00	U	76929.9	69,70	0,15

LAVE-MAINS

Metropolitan



**EXCLUSIVITES RICHARDSON PAR
GBGROUP**

Lave-mains



	DÉSIGNATION	UT	CODE	PPHT (€)	ECOPART (€)
748.0099.66	LAVE-MAINS METROPOLITAN 41CM SIMP/VASQ. TK020	U	201CB.7	125,41	0,83

Jacob Delafon
PARIS

ODEON UP

Lave-mains - Percé, 1 trou à droite



	DÉSIGNATION	UT	CODE	PPHT (€)	ECOPART (€)
704.0092.20	LAVE-MAINS ODEON UP 40X25CM BLC JD E47996-00	U	9422B.7	115,31	0,06

LAVABO, LAVE-MAINS, VASQUE

LAVE-MAINS

Jacob Delafon
PARIS

ODEON UP

Lave-mains - Percé, 1 trou à gauche



	DÉSIGNATION	UT	CODE	PPHT (€)	ECOPART (€)
704.0092.20	LAVE-MAINS ODEON UP 40X25 BLC JD E47596-00	U	9421J.2	115,31	0,06

Jacob Delafon
PARIS

ODEON RIVE GAUCHE

Lave-mains - Autoportant ou
montage sur meuble spécifique



	DÉSIGNATION	UT	CODE	PPHT (€)	ECOPART (€)
704.0073.96	LAVE-MAINS ODEON RIVE GCH 50/GCH EGO112-55-00	U	338J1.2	92,51	0,06

Jacob Delafon
PARIS

ODEON RIVE GAUCHE

Lave-mains - Angle autoportant ou montage
sur meuble spécifique



	DÉSIGNATION	UT	CODE	PPHT (€)	ECOPART (€)
704.0073.96	LAVE-MAIN ANG.ODEON RIVE GCH 34X34 EGP112-00	U	346CB.0	92,51	0,06

Vittra

NORMUS

Lave-mains



	DÉSIGNATION	UT	CODE	PPHT (€)	ECOPART (€)
000.0047.20	LAVE-MAINS NORMUS 45 1TR 5078L003-1029	U	175W2.9	59,06	0,06

Le PPHT comprend l'ecopart (€)

100% Exclusivités

Meubles de salle de bains

eazy
par GB



Pro

Metropolitan
par GB



Essentiel

UPcity
par burgbad



Tendance

Sign
par DECOTEC



Design

Les gammes exclusives,
Le meilleur atout des Pros

- Des prix publics attractifs
- La qualité des grandes marques
- Produits et pièces détachées disponibles rapidement

Retrouvez tous les produits
exclusifs dans nos catalogues !



RICHARDSON

Le PPHT comprend l'ecopart (€)

LAVABO, LAVE-MAINS, VASQUE

ROBINETTERIE DE LAVABO/LAVE-MAINS



Metropolitan
EXCLUSIVITES RICHARDSON PAR NOBILI
Mitigeur lavabo - Bec standard



	DÉSIGNATION	UT	CODE	PPHT (€)	ECOPART (€)
748.0077.93	MITIGEUR LAV.METRO 2.C3 CHR MEE99118/1CR	U	28709.3	97,42	0,01



Metropolitan
EXCLUSIVITES RICHARDSON PAR NOBILI
Mitigeur lavabo - Surélevé



	DÉSIGNATION	UT	CODE	PPHT (€)	ECOPART (€)
748.0125.26	MITIGEUR LAV.SUREL.CC METRO 2. MEE99128/2CR	U	28708.6	156,59	0,01



Metropolitan
EXCLUSIVITES RICHARDSON PAR NOBILI
Mitigeur lavabo - Bec haut/mobile



	DÉSIGNATION	UT	CODE	PPHT (€)	ECOPART (€)
748.0139.33	MITIGEUR LAV.HT METRO 2.CHR ME99338/2CR	U	28708.8	174,17	0,01



UPcity
EXCLUSIVITES RICHARDSON PAR NOBILI
Mitigeur Lavabo - Standard



	DÉSIGNATION	UT	CODE	PPHT (€)	ECOPART (€)
593.0093.12	MITIGEUR LAV UPCITY V/LAIT.CHR UPC112118/1CR	U	200KM.9	124,17	0,01
593.0109.37	MITIGEUR LAV UPCITY V.C/C CHR UPC112118/2CR	U	200KQ.3	145,84	0,01
593.0149.37	MITIGEUR LAV UPCITY V/L NOIR/M UPC112118/1BM	U	200KP.5	199,17	0,01
593.0180.00	MITIGEUR LAV UPCITY V.C/C NOIR UPC112118/2BM	U	200P.7	240,01	0,01



UPcity
EXCLUSIVITES RICHARDSON PAR NOBILI
Mitigeur Lavabo - Bec haut



	DÉSIGNATION	UT	CODE	PPHT (€)	ECOPART (€)
593.0278.74	MITIGEUR LAV UPCITY HAUT NOIR UPC117338/2BM	U	200KT.7	371,67	0,01

Sanitaire
Cuisine

LAVABO, LAVE-MAINS, VASQUE

ROBINETTERIE DE LAVABO/LAVE-MAINS



EXCLUSIVITES RICHARDSON PAR NOBILI

Mitigeur Lavabo - Bec surélevé



	DÉSIGNATION	UT	CODE	PPHT (€)	ECOPART (€)
593.0156.25	MITIGEUR LAV UPCITY SURELE. CHR UPC184128/2CR	U	200KU.4	208,34	0,01



EXCLUSIVITES RICHARDSON PAR PAINI FRANCE

Mitigeur lavabo - Bec bas



	DÉSIGNATION	UT	CODE	PPHT (€)	ECOPART (€)
592.0044.48	MITIGEUR LAV. BEC BAS C3 EAZY EZCR211	U	3770L.8	55,61	0,01



EXCLUSIVITES RICHARDSON PAR PAINI FRANCE

Mitigeur lavabo - Bec haut



	DÉSIGNATION	UT	CODE	PPHT (€)	ECOPART (€)
592.0044.96	MITIGEUR LAV. BEC HAUT C3 EAZY EZCR05	U	37711.9	56,21	0,01



BAULOOP

Mitigeur lavabo - Monocommande bec fixe



	DÉSIGNATION	UT	CODE	PPHT (€)	ECOPART (€)
762.0066.74	MITIGEUR LAV. BAULOOP T.S CHR GROHE 22054001	U	299DS.8	83,45	0,02
762.0090.43	MITIGEUR LAV. BAULOOP T.M CHR GROHE 23887001	U	286RL.9	100,50	0,02
762.0122.35	MITIGEUR LAV. BAULOOP T.XL CHR GROHE 23764001	U	304NB.8	135,97	0,02



EUROSMART

Mitigeur lavabo - Bec fixe - Taille S



	DÉSIGNATION	UT	CODE	PPHT (€)	ECOPART (€)
762.0096.05	MITIGEUR LAV. EUROSMART OHM T.S CHR 32926003	U	323K5.4	96,07	0,02

LAVABO, LAVE-MAINS, VASQUE

ROBINETTERIE DE LAVABO/LAVE-MAINS



EUROSMART

Mitigeur lavabo - Bec fixe - Taille M



	DÉSIGNATION	UT	CODE	PPHT (€)	ECOPART (€)
762.0109.94	MITIGEUR EUROSMART MONO. 1/2 T.M CHR 23322003	U	319ZL.0	109,96	0,02
762.0109.94	MITIGEUR LAV EUROSMART 2021 GROHE 2339330E	U	323X3.2	109,96	0,02



EUROSMART

Mitigeur lavabo - Bec tube pivotant - Taille L



	DÉSIGNATION	UT	CODE	PPHT (€)	ECOPART (€)
762.0157.52	MITIGEUR LAV EUROSMART 1/2 T.L CHR 23537003	U	319ZM.8	157,54	0,02



UNIVERSAL

Robinet monofluide pour lave-mains - Bec C



	DÉSIGNATION	UT	CODE	PPHT (€)	ECOPART (€)
762.0107.45	ROBINET SIMPLE LAV. BEC C GROHE 20201000	U	65044.0	119,41	0,02

hansgrohe

LOGIS 70

Mitigeur lavabo



	DÉSIGNATION	UT	CODE	PPHT (€)	ECOPART (€)
765.0088.79	MITIGEUR LAV.LOGIS 70 CHR H.GROHE 71072000	U	7705U.2	98,67	0,02

hansgrohe

METRIS 110

Mitigeur lavabo - Bec fixe



	DÉSIGNATION	UT	CODE	PPHT (€)	ECOPART (€)
765.0258.73	MITIGEUR LAV.METRIS 110 H.GROHE 31080000	U	5664B.2	287,50	0,02

hansgrohe

TALIS E

Mitigeur lavabo - 110 - Bec fixe



	DÉSIGNATION	UT	CODE	PPHT (€)	ECOPART (€)
765.0215.94	MITIGEUR LAV.TALIS E 110 H.GROHE 71710670	U	239RC.6	239,95	0,02

Le PPHT comprend l'ecopart (€)

LAVABO, LAVE-MAINS, VASQUE

ROBINETTERIE DE LAVABO/LAVE-MAINS

hansgrohe

TALIS E 110

Mitigeur lavabo



	DÉSIGNATION	UT	CODE	PPHT (€)	ECOPART (€)
765.0278.42	MITIGEUR LAV.110 TALIS E BRONZE/BR 71710140	U	272R3.7	278,44	0,02

hansgrohe

TICA

Une exclusivité RICHARDSON



	DÉSIGNATION	UT	CODE	PPHT (€)	ECOPART (€)
765.0089.66	MITIGEUR LAV TICA 70 COOLSTART CHR 14176000	U	319JQ.2	112,09	0,01
765.0113.20	MITIGEUR LAV TICA 100 COOLSTART. CHR 14177000	U	319K3.7	141,51	0,01

hansgrohe

CORPS D'ENCASTREMENT

Metris Classic - Pour mitigeur lavabo



	DÉSIGNATION	UT	CODE	PPHT (€)	ECOPART (€)
765.0234.28	CORPS ENC.LAV.METRIS CLASSIC H.GROHE 13622180	U	5355C.4	260,33	0,02

hansgrohe

VERNIS BLEND

Mitigeur de lavabo 100 coolstar avec tirette et vidange



	DÉSIGNATION	UT	CODE	PPHT (€)	ECOPART (€)
765.0115.90	MITIGEUR LAV. 100 VERNIS BLEND NOIR 71585670	U	335BM.2	144,89	0,02
765.0084.20	MITIGEUR LAV.100 COOLSTART VERN.B CH 71585000	U	335BP.8	105,27	0,02

hansgrohe

VERNIS BLEND

Mitigeur de lavabo électronique avec pré-reglage de la température



	DÉSIGNATION	UT	CODE	PPHT (€)	ECOPART (€)
765.0233.26	MITIGEUR LAV.ELECT.VERN/BLEND BATT. 71502000	U	335L3.2	259,20	0,02

hansgrohe

VERNIS BLEND

Mitigeur de lavabo 70 CoolStart - Avec tirette et vidage synthétique



	DÉSIGNATION	UT	CODE	PPHT (€)	ECOPART (€)
765.0072.32	MITIGEUR LAV.VERNIS 70 CHR H.GROHE 71584000	U	331VD.5	80,38	0,02
765.0089.64	MITIGEUR LAV VERNIS BLEND 70 NOIR/M 71584670	U	344SU.8	112,07	0,02

Le PPHT comprend l'ecopart (€)

LAVABO, LAVE-MAINS, VASQUE

ROBINETTERIE DE LAVABO/LAVE-MAINS

Jacob Delafon
PARIS

BRIVE

Mitigeur Lavabo



	DÉSIGNATION	UT	CODE	PPHT (€)	ECOPART (€)
767.0080.12	MITIGEUR LAV. BRIVE C3 A/VID. CHR E75759-4-CP	U	224V8.3	100,17	0,02
767.0080.12	MITIGEUR LAV.BRIVE 5L/M A/VID.CHR E75760-4-CP	U	224VC.4	100,17	0,02

Jacob Delafon
PARIS

EASY

Mitigeur lavabo - Easy



	DÉSIGNATION	UT	CODE	PPHT (€)	ECOPART (€)
704.0120.88	MITIGEUR LAV. JULY EASY CHR E16024-4-CP	U	4167D.3	151,12	0,02
704.0112.56	MITIGEUR LAV. S/V.JULY EASY CHR E16024-4ND-CP	U	4301E.7	140,72	0,02

Jacob Delafon
PARIS

JULY

Mitigeur lavabo



	DÉSIGNATION	UT	CODE	PPHT (€)	ECOPART (€)
767.0085.36	MITIGEUR LAV.JULY CHR JD E16027-4-CP	U	3265L.0	106,72	0,02

Palmi France
ROBINETTERIE

ORCHIDEATEVE

Mélangeur lavabo à pont



	DÉSIGNATION	UT	CODE	PPHT (€)	ECOPART (€)
768.0122.66	MELANGEUR LAV.A PONT ORCHIDEA TEV. TZCR215NF	U	1133U.7	153,33	

VIDAGE/SIPHON DE LAVABO/LAVE-MAINS

TEKNIK



EXCLUSIVITES RICHARDSON PAR CGS

Bonde lavabo - Universelle



	DÉSIGNATION	UT	CODE	PPHT (€)	ECOPART (€)
000.0047.40	BONDE LAV. CLIC-CLAC TEKNIK CHR SK300.01NZ	U	275CZ.5	47,41	0,01
000.0061.50	BONDE LAV. CLIC-CLAC TEKNIK NOIR/M SK300.43N	U	275D0.4	61,51	0,01
000.0029.70	BONDE LAV.UNIV. TEKNIK RECOUP. CHR SK550.01	U	275D4.6	29,71	0,01

LAVABO, LAVE-MAINS, VASQUE

VIDAGE/SIPHON DE LAVABO/LAVE-MAINS



EXCLUSIVITES RICHARDSON PAR CGS

Bonde lave-mains



	DÉSIGNATION	UT	CODE	PPHT (€)	ECOPART (€)
000.0041.10	BONDE L/M TEKNIK CLIC-CLAC CHR SK301.01NZ	U	275DH.7	41,11	0,01
000.0067.80	BONDE L/M TEKNIK CLIC-CLAC NOIR/M SK301.43N	U	275D3.8	67,81	0,01
000.0039.90	BONDE L/M TEKNIK 30-45CM CHR SK301.01SA	U	275D1.2	39,91	0,01
000.0066.50	BONDE L/M TEKNIK 30-45 NOIR MAT SK301.43SA	U	275D2.0	66,51	0,01



EXCLUSIVITES RICHARDSON PAR CGS

Siphon lavabo



	DÉSIGNATION	UT	CODE	PPHT (€)	ECOPART (€)
000.0103.10	SIPHON LAV DESIGN TEKNIK CHR AL500.01	U	275D6.1	103,11	0,01
000.0132.50	SIPHON LAV DESIGN TEKNIK NOIR MAT AL500.43	U	275D7.9	132,51	0,01

hansgrohe

BONDE LAVABO / LAVE MAINS

A écoulement libre



	DÉSIGNATION	UT	CODE	PPHT (€)	ECOPART (€)
765.0041.76	BONDE LAV. 1 1/4 CHR H.GROHE 50001000	U	4366B.6	46,42	0,02

hansgrohe

FLOWSTAR S



	DÉSIGNATION	UT	CODE	PPHT (€)	ECOPART (€)
765.0081.49	SIPHON LAV. FLOWSTAR S CHR H.GROHE 52105000	U	91194.1	90,57	0,02



BONDE

A bouchon ou à grille - Laiton - Bouchon chaînette



	DÉSIGNATION	UT	CODE	PPHT (€)	ECOPART (€)
757.0016.79	BONDE LAV. BOUCHON CHAINET. CHR L2260 0501020	U	79804.1	22,41	0,02

LAVABO, LAVE-MAINS, VASQUE

VIDAGE/SIPHON DE LAVABO/LAVE-MAINS



BONDE

A bouchon ou à grille - Laiton - Grille



	DÉSIGNATION	UT	CODE	PPHT (€)	ECOPART (€)
757.0013.71	BONDE A GRILLE D55 INOX/LAIT. L2262 0501026	U	34785.6	18,30	0,02



BONDE

A bouchon ou à grille - Plastique - Bouchon chaînette



	DÉSIGNATION	UT	CODE	PPHT (€)	ECOPART (€)
757.0009.85	BONDE LAV. BOUCHON CHAINETTE L260 0201019	U	28396.0	13,15	0,02



BONDE

A bouchon ou à grille - Plastique - Grille



	DÉSIGNATION	UT	CODE	PPHT (€)	ECOPART (€)
757.0008.73	BONDE LAVE-MAINS AV.GRILLE D55 L262 0201031	U	41109.0	11,66	0,02



BONDE

A clapet laiton automatique - Sans tirette



	DÉSIGNATION	UT	CODE	PPHT (€)	ECOPART (€)
757.0044.97	BONDE LAV.AUTO LAIT.CHR BR. L3212 0501030	U	28629.4	59,98	0,02



BONDE

A clapet laiton automatique - Tirette lavabo-bidet



	DÉSIGNATION	UT	CODE	PPHT (€)	ECOPART (€)
757.0011.66	TIRETTE LAV./BIDET CHR L213 0201004	U	65484.8	15,57	0,02



BONDE

A clapet plastique automatique - Sans tirette



	DÉSIGNATION	UT	CODE	PPHT (€)	ECOPART (€)
757.0016.18	BONDE LAV.AUTO SS TIRETTE L212 0201005	U	35581.8	21,60	0,02

Le PPHT comprend l'ecopart (€)

LAVABO, LAVE-MAINS, VASQUE

VIDAGE/SIPHON DE LAVABO/LAVE-MAINS



by aliaxis

BONDE

Laiton Design - A écoulement libre pour vasque sans trop-plein - Avec bague de compensation



	DÉSIGNATION	UT	CODE	PPHT (€)	ECOPART (€)
757.0067.99	BONDE LAV.LAIT.DESIGN EC.LIBRE L3219 0501085	U	23891.5	90,67	0,02



by aliaxis

BONDE

Laiton Design - A écoulement libre pour vasque sans trop-plein - Clapet fixe recouvrant



	DÉSIGNATION	UT	CODE	PPHT (€)	ECOPART (€)
757.0048.54	BONDE LAV.FILETEE CLAPET FIXE L2264 0501078	U	6089A.9	64,74	0,02



by aliaxis

BONDE

Laiton Design - A clapet pour vasque avec trop-plein - Commande à main - Clapet rond recouvrant



	DÉSIGNATION	UT	CODE	PPHT (€)	ECOPART (€)
757.0064.84	BONDE LAV.DESIGN AUTO CDE MAIN L3218 0501084	U	64926.9	86,47	0,02



by aliaxis

BONDE

Laiton Design - Universel - A clapet pour vasque avec trop-plein - Clapet rond recouvrant



	DÉSIGNATION	UT	CODE	PPHT (€)	ECOPART (€)
757.0053.00	BONDE UNIV.CLAPET CDE MAIN CHR L32UM 0501172	U	71801.8	66,27	0,02



by aliaxis

EASYPHON

Siphon lavabo plastique - ø 32 mm - Réglable en hauteur (133 - 192 mm) - Avec joints intégrés



	DÉSIGNATION	UT	CODE	PPHT (€)	ECOPART (€)
757.0005.42	SIPHON LAV.EASYPHON 11/4 BIMAT.BM211 0201282	U	1493K.0	7,24	0,02

LAVABO, LAVE-MAINS, VASQUE

VIDAGE/SIPHON DE LAVABO/LAVE-MAINS



by aliaxis

INTERCALAIRE DE BONDE

Avec grille ø 24 mm pour trou de trop-plein ø 25 à 30 mm



	DÉSIGNATION	UT	CODE	PPHT (€)	ECOPART (€)
757.0018.62	BONDE INTERCAL.00-10 A GRIL.D30 910FE 0204160	U	19059.5	24,85	0,02



by aliaxis

SIPHON

Laiton - Non réglable en hauteur (H 112 mm)



	DÉSIGNATION	UT	CODE	PPHT (€)	ECOPART (€)
757.0031.32	SIPHON LAV.1 1/4 LAIT.CHR.MAT L2211 0501012	U	68017.3	41,78	0,02



by aliaxis

SIPHON

Laiton - Réglable en hauteur (117 - 172 mm)



	DÉSIGNATION	UT	CODE	PPHT (€)	ECOPART (€)
757.0037.73	SIPHON LAV.LAIT.CHR.BR. L3211 0501022	U	30618.3	50,33	0,02



by aliaxis

SIPHON

Laiton - Lavabo/bidet - Réglable en hauteur (100 - 150 mm)



	DÉSIGNATION	UT	CODE	PPHT (€)	ECOPART (€)
757.0038.92	SIPHON LAV/BIDET LAIT.CHR.BR. L2311 0501025	U	39200.1	51,92	0,02



by aliaxis

SIPHON

Laiton - Forme "S" - Non réglable en hauteur



	DÉSIGNATION	UT	CODE	PPHT (€)	ECOPART (€)
757.0042.22	SIPHON LAV. S 1 1/4 CHR BR. L2231 0501027	U	28625.2	56,31	0,02



by aliaxis

SIPHON

Plastique - Réglable en hauteur (132 - 172 mm)



	DÉSIGNATION	UT	CODE	PPHT (€)	ECOPART (€)
757.0003.58	SIPHON LAV.TUBE REGLABLE 1 1/4 L211 0201001	U	35573.5	4,79	0,02

Le PPHT comprend l'ecopart (€)

LAVABO, LAVE-MAINS, VASQUE

VIDAGE/SIPHON DE LAVABO/LAVE-MAINS



by atlixis

SIPHON

Plastique - Réglable en hauteur (142 - 185 mm)



	DÉSIGNATION	UT	CODE	PPHT (€)	ECOPART (€)
757.0008.62	SIPHON LAV.TUBE REGLABLE 1 1/4-40 0201022	U	62834.7	11,52	0,02



by atlixis

SIPHON

Plastique - Chromé - Réglable en hauteur (132 - 172 mm)



	DÉSIGNATION	UT	CODE	PPHT (€)	ECOPART (€)
757.0038.87	SIPHON LAV.REGLABLE 1 1/4 CHR L211M 0201231	U	76198.1	38,89	0,02



by atlixis

TUBULURE

Plastique - Sortie arrière gain de place - Blanc



	DÉSIGNATION	UT	CODE	PPHT (€)	ECOPART (€)
757.0010.15	TUBULURE LAV.SORT.ARR.1 1/4 L268 0201029	U	29001.5	13,55	0,02



by atlixis

TUBULURE

Plastique - Sortie arrière gain de place - Chromé



	DÉSIGNATION	UT	CODE	PPHT (€)	ECOPART (€)
757.0028.53	TUBULURE LAV.SORT.ARR.1 1/4 CHR L268M 0201248	U	76213.8	38,06	0,02



SIPHON

ABS Chromé - Design - Modèle Long réglable en hauteur (133,5 - 203,5 mm)

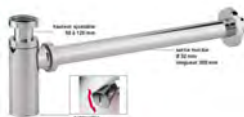

	DÉSIGNATION	UT	CODE	PPHT (€)	ECOPART (€)
757.0046.22	SIPHON SORTIE MUR.30 CHR VALENTIN 13070000000	U	9941N.5	46,24	0,02



NEO AIR SYSTEM

Siphon avec bonde - Néo Air System



	DÉSIGNATION	UT	CODE	PPHT (€)	ECOPART (€)
714.0005.58	SIPHON LAV.NEO AIR SYSTEM D.32 30722148	U	193HZ.5	6,99	0,02

LAVABO, LAVE-MAINS, VASQUE

VIDAGE/SIPHON DE LAVABO/LAVE-MAINS



QUICK-CLAC

Bonde



	DÉSIGNATION	UT	CODE	PPHT (€)	ECOPART (€)
714.0046.71	BONDE LAV. NANO 6.7 D32 QUICK CLAC B 30723974	U	A04WX.6	46,73	0,02



SENZO

Siphon plastique pour lavabo - Extraplat



	DÉSIGNATION	UT	CODE	PPHT (€)	ECOPART (€)
759.0023.19	SIPHON LAV.SENZO SS GARDE EAUWIRQUIN 30720471	U	6739W.0	23,19	

Pour plus d'infos,
consultez
le CAHIER TECHNIQUE
page 14



Hotline 06 27 52 64 95

www.richardson.fr/services/green-solutions

Le PPHT comprend l'ecopart (€)

100% Exclusivités

Parois de douche

eazy
par LEDA



Pro

Metropolitan
par **Roth**

UPcity
par **NOVELLINI**



Essentiel



Tendance

Les gammes exclusives,
Le meilleur atout des Pros

- Des prix publics attractifs
- La qualité des grandes marques
- Produits et pièces détachées disponibles rapidement

Retrouvez tous les produits
exclusifs dans nos catalogues !



RICHARDSON

Le PPHT comprend l'ecopart (€)

DOUCHE

RECEVEUR A ENCASTRER

Jacob Delafon
PARIS

KYREO

Receveur carré en céramique à encastrer - Pour bonde ø 60 mm



	DÉSIGNATION	UT	CODE	PPHT (€)	ECOPART (€)
704.0134.48	RECEVEUR CARRE KYREO 80CM ENC. BLC ENB90-00	U	2010K.1	168,84	0,74
704.0218.96	RECEVEUR CARRE KYREO 90CM ENC. BLC ENC90-00	U	2010N.5	274,44	0,74

Jacob Delafon
PARIS

KYREO

Receveur rectangulaire - Extraplat à poser ou à encastrer, céramique



	DÉSIGNATION	UT	CODE	PPHT (€)	ECOPART (€)
704.0229.00	RECEVEUR RECT. KYREO ENC. 90X70 BLC ENE90-00	U	2010Z.3	286,99	0,74
704.0338.52	RECEVEUR RECT. KYREO ENC. 120X80 BLC ENG90-00	U	201R3.6	423,89	0,74
704.0318.56	RECEVEUR RECT. KYREO ENC. 100X80 BLC ENF90-00	U	201R2.8	398,94	0,74
704.0286.48	RECEVEUR RECT. KYREO 100X70 ENN90-00	U	286FQ.7	358,84	0,74
704.0316.28	RECEVEUR RECT. KYREO 120X70 A/P BLC ENO90-00	U	286FR.5	396,09	0,74
704.0382.56	RECEVEUR RECT. KYREO 120X90 B/GCH ENP902-00	U	286FS.3	478,94	0,74

Kinedo

KINESURF

Receveur carré ultra-plat à encastrer en Biotec - Avec bonde extra-plate et grille d'évacuation amovible en inox chromé



	DÉSIGNATION	UT	CODE	PPHT (€)	ECOPART (€)
740.0292.80	RECEVEUR KINESURF 80X80 BLANC RD1100	U	166HT.3	366,74	0,74
740.0339.20	RECEVEUR KINESURF 90X90 BLC RD1101	U	166J1.7	424,74	0,74
740.0368.00	RECEVEUR KINESURF 100X100 BLC RD1102	U	166J8.2	460,74	0,74

Kinedo

KINESURF

Receveur rectangulaire à encastrer

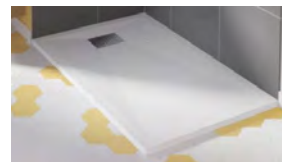

	DÉSIGNATION	UT	CODE	PPHT (€)	ECOPART (€)
740.0535.20	RECEVEUR KINESURF 160X90 BLC RD1162	U	172CG.9	669,74	0,74

Kinedo

KINESURF

Receveur rectangulaire à encastrer



	DÉSIGNATION	UT	CODE	PPHT (€)	ECOPART (€)
740.0316.00	RECEVEUR KINESURF 80X100 BLC RD1107	U	214UP.2	395,74	0,74

DOUCHE

RECEVEUR A ENCASTRER



LIFETIME PLUS

Receveur ultraplat - Pour bonde de Ø 90 mm, centrée sur le côté



	DÉSIGNATION	UT	CODE	PPHT (€)	ECOPART (€)
706.0589.00	RECEVEUR LIFETIME+ 120X90 BLC VB 6223N401	U	77574.2	589,49	0,49
706.0557.00	RECEVEUR LIFETIME+ 120X80 BLC VB 6223N301	U	76252.6	557,49	0,49
706.0332.80	RECEVEUR LIFETIME+ 90X90 BLC VB 6223D401	U	77560.9	416,49	0,49
706.0534.00	RECEVEUR LIFETIME+ 100X80 BLC VB 6223J301	U	77570.0	534,49	0,49

Vittra

RECEVEUR A ENCASTRER

Cascade - Ultraplat



	DÉSIGNATION	UT	CODE	PPHT (€)	ECOPART (€)
000.0164.80	RECEVEUR ENC.CASCADE LIS.80X80 5761L003M0578	U	9229T.8	206,74	0,74
000.0216.80	RECEVEUR ENC.CASCADE LIS.90X90 5762L003M0578	U	9230T.8	271,74	0,74
000.0237.60	RECEVEUR ENC.CASCADE LIS.100X80 5763L003M0695	U	169VS.1	297,74	0,74
000.0296.80	RECEVEUR ENC.CASCADE LIS.120X80 5764L003M0695	U	169X0.3	371,74	0,74
000.0366.40	RECEVEUR ENC.CASCADE LIS.120X90 5765L003M0695	U	169XT.7	458,74	0,74
000.0460.80	RECEVEUR CASCADE ENC. 140X90 5766L003M0695	U	169XU.4	576,74	0,74

J+0 100% Dispo



SCANNEZ, commandez,

Téléchargez sur

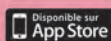

100% Exclusivités

TEKNIK

par LAZER
L'innovation en action

PIEDS DE RECEVEUR

- Fabrication française
- Fabriqué à 99% à partir de lastique recyclé
- Encombrement réduit
- Stabilité haute renforcée



- Autobloquant
- Réglage de 68 à 125 cm
- Possibilité d'ajouter une rallonge H 36 cm 

Existe en lot de 4 pieds
et en carton de 30 pieds

Uniquement chez
RICHARDSON

Le PPHT comprend l'ecopart (€)

DOUCHE

RECEVEUR SURELEVE, A POSER

GEBERIT

BASTIA

Receveur carré à poser - Pour bonde siphon ø 90 mm



	DÉSIGNATION	UT	CODE	PPHT (€)	ECOPART (€)
702.0136.47	RECEVEUR CAR.BASTIA 70X70AP 00720200000001	U	81010.1	171,33	0,74
702.0154.63	RECEVEUR CAR.BASTIA 80X80AP 00721200000001	U	81015.0	194,03	0,74



AEROBLOC

Receveur extraplat à encastrer ou à poser, acrylique - Rectangulaire



	DÉSIGNATION	UT	CODE	PPHT (€)	ECOPART (€)
704.0292.40	RECEVEUR AEROBLOC 100X80X3,8 BLC NF E62103-00	U	263V0.6	366,24	0,74
704.0340.24	RECEVEUR AEROBLOC 120X90X3,8 BLC NF E62105-00	U	263VS.2	426,04	0,74
704.0397.80	RECEVEUR AEROBLOC 140X90X4,3 BLC E62107-00	U	263VU.7	497,99	0,74



AEROBLOC

Receveur extraplat à encastrer ou à poser, acrylique - Carré



	DÉSIGNATION	UT	CODE	PPHT (€)	ECOPART (€)
704.0196.60	RECEVEUR BRIVE 80X80X3,3 BLC NF E62101-00	U	263VN.0	246,49	0,74
704.0249.16	RECEVEUR AEROBLOC 90X90X3,3 BLC NF E62102-00	U	263VP.8	312,19	0,74



KYREO

Receveur carré à poser en céramique - Pour bonde ø 90 mm (bonde à droite)



	DÉSIGNATION	UT	CODE	PPHT (€)	ECOPART (€)
704.0382.56	RECEVEUR RECT. KYREO 120X90 B/DRTE ENP903-00	U	302CB.3	478,94	0,74



KINESURF



	DÉSIGNATION	UT	CODE	PPHT (€)	ECOPART (€)
740.0292.00	RECEVEUR KINESURF 70X90 BLC RD1105	U	171M8.9	365,74	0,74
740.0415.20	RECEVEUR KINESURF 120X90 BLC RD1152	U	170P2.7	519,74	0,74
740.0359.20	RECEVEUR KINESURF 120X80 BLC RD1151	U	170RT.1	449,74	0,74
740.0432.00	RECEVEUR KINESURF 140X80 BLC RD1155	U	170RU.8	540,74	0,74
740.0574.00	RECEVEUR KINESURF 140X90 BLC RD1156	U	170RV.6	574,74	0,74
740.0509.60	RECEVEUR KINESURF 170X80 BLC RD1165	U	171LQ.5	637,74	0,74
740.0343.20	RECEVEUR KINESURF 120X70 BLC RD1150	U	171MS.0	429,74	0,74
740.0516.00	RECEVEUR KINESURF 140X100 BLC RD1157	U	172PK.5	645,74	0,74

Le PPHT comprend l'ecopart (€)

DOUCHE

RECEVEUR SURELEVE, A POSER

Kinedo

KINESURF



	DÉSIGNATION	UT	CODE	PPHT (€)	ECOPART (€)
740.0501.60	RECEVEUR KINESURF 160X80 BLC RD1161	U	173GB.4	627,74	0,74
740.0440.80	RECEVEUR KINESURF 170X70 BLC RD1164	U	174GY.7	551,74	0,74
740.0573.60	RECEVEUR KINESURF 170X90 BLC RD1166	U	177C4.5	717,74	0,74
740.0356.30	RECEVEUR KINESURF 140X70 BLC RD1154	U	211G0.6	509,74	0,74
740.0354.40	RECEVEUR KINESURF 100X90 BLC RD1108	U	170RW.4	443,74	0,74
740.0432.00	RECEVEUR KINESURF 160X70 BLC RD1160	U	178AU.2	540,74	0,74
740.0298.40	RECEVEUR KINESURF 4CM 100X70 BLC RD1106	U	173GU.7	373,74	0,74



SILLAR ST

Receveur rectangulaire extraplat, synthèse - Résine Gelcoat - Teinté dans la masse - Antidérapant PN24



	DÉSIGNATION	UT	CODE	PPHT (€)
520.0401.81	RECEVEUR SILLAR 140X80 BLC G9928014101	U	185TT.7	502,26
520.0409.18	RECEVEUR SILLAR 120X90 BLC G9929012101	U	185VN.5	511,48
520.0465.76	RECEVEUR SILLAR 140X90 BLC G9929014101	U	186VU.0	582,20
520.0364.91	RECEVEUR SILLAR 120X80 GRAFITO G9928012103	U	310FX.0	456,14
520.0401.81	RECEVEUR SILLAR 140X80 GRAFITO G9928014103	U	310G0.6	502,26
520.0409.18	RECEVEUR SILLAR 120X90 GRAFITO G9929012103	U	310G1.4	511,48
520.0465.76	RECEVEUR SILLAR 140X90 GRAFITO G9929014103	U	310G2.2	582,20

RECEVEUR A CARRELER



I-DRAIN

Caniveau de douche à encastrer



	DÉSIGNATION	UT	CODE	PPHT (€)
025.0195.00	CANIVEAU IDRAIN ABS 70CM ID4P07001X0	U	12542.7	260,00
025.0206.25	CANIVEAU IDRAIN ABS 90CM ID4P09001X1	U	12550.0	275,00
025.0201.00	CANIVEAU IDRAIN ABS 80CM ID4P08001X1	U	1254Y.2	268,00



I-DRAIN

Caniveau de douche à encastrer - Sans grille



	DÉSIGNATION	UT	CODE	PPHT (€)
025.0364.50	CANIVEAU 80CM AV.ETANCH.1 SIPHON ID4M08001X1	U	9499I.0	486,00
025.0349.50	CANIVEAU 70CM AV.ETANCH.1 SIPHON ID4M07001X1	U	9498I.1	466,00
025.0377.26	CANIVEAU 90CM AV.ETANCH.1 SIPHON ID4M09001X1	U	9499J.9	503,01
025.0392.26	CANIVEAU 100CM AV.ETANCH.1 SIPHON ID4M10001X1	U	9499L.5	523,01

DOUCHE

RECEVEUR A CARRELER



I-DRAIN

Grille de sol - A carreler



	DÉSIGNATION	UT	CODE	PPHT (€)
025.0077.25	GRILLE A CARRELER 70CM IDRO0700Y	U	9502I.5	103,00
025.0081.75	GRILLE A CARRELER 80CM IDRO0800Y	U	9502K.2	109,00
025.0084.75	GRILLE A CARRELER 90CM IDRO0900Y	U	9502L.0	113,00
025.0088.50	GRILLE A CARRELER 100CM IDRO1000Y	U	95034.5	118,00



I-DRAIN

Grille de sol - Plano brillante - A encastrer



	DÉSIGNATION	UT	CODE	PPHT (€)
025.0066.00	GRILLE INOX PLANO BRILLANTE 80CM IDRO0800F	U	9899L.1	88,00
025.0063.00	GRILLE INOX PLANO BRILLANTE 70CM IDRO0700F	U	9899K.3	84,00
025.0069.00	GRILLE INOX PLANO BRILLANTE 90CM IDRO0900F	U	99000.2	92,00
025.0072.00	GRILLE INOX PLANO BRILLANTE 100CM IDRO1000F	U	99002.8	96,00



I-DRAIN

Grille de sol - Plano mate



	DÉSIGNATION	UT	CODE	PPHT (€)
025.0063.00	GRILLE INOX PLANO MATE 70CM IDRO0700A	U	9500E.5	84,00
025.0066.00	GRILLE INOX PLANO MATE 80CM IDRO0800A	U	9502D.6	88,00
025.0069.00	GRILLE INOX PLANO MATE 90CM IDRO0900A	U	9502F.1	92,00
025.0072.00	GRILLE INOX PLANO MATE 100CM IDRO1000A	U	9502H.7	96,00



I-DRAIN

Pièce de raccordement



	DÉSIGNATION	UT	CODE	PPHT (€)
025.0087.00	ACCOUPLEMENT DRTE P.DRAIN 54/72MM ID000007S3	U	5803J.8	116,00



FLIGHT

Accessoires - Kit de réhausse numéro 5



	DÉSIGNATION	UT	CODE	PPHT (€)	ECOPART (€)
704.0065.00	REHAUSSE HT.16.5CM S.TABL.-KIT-JD E62472-00	U	4616F.5	81,27	0,02

DOUCHE

RECEVEUR A CARRELER



ISOTANCHE CLASSIC PRO

Bonde - Ø 50 - Sortie horizontale



	DÉSIGNATION	UT	CODE	PPHT (€)	ECOPART (€)
025.0144.43	BONDE DCHE ISOT.CAR.SH 1200X1200 LAZER 230460	U	1745K.6	192,58	0,01



ISOTANCHE PANODUR

Receveur à carreler constitué de panneaux à carreler en Polystyrène extrudé, renforcé et préparé pour la pose directe de carrelage - Trou central



	DÉSIGNATION	UT	CODE	PPHT (€)	ECOPART (€)
025.0314.18	SOL PANODUR CARRE 90X90 S/BONDE LAZER 340100	U	0528I.4	418,92	0,01
025.0341.72	SOL PANODUR CARRE 120X120 S/BONDELAZER 340120	U	0528J.3	455,64	0,01
025.0393.21	SOL PANODUR CARRE 150X150 S/BONDELAZER 340130	U	0528K.1	524,29	0,01



ISOTANCHE PANODUR

Receveur à carreler constitué de panneaux à carreler en Polystyrène extrudé, renforcé et préparé pour la pose directe de carrelage - Trou excentré



	DÉSIGNATION	UT	CODE	PPHT (€)	ECOPART (€)
025.0342.87	SOL PANODUR RECT. A/CAR. 120X90 LAZER 340161	U	5037C.0	457,17	0,01



NATOSSEC

SOLS ET MURS - Angle



	DÉSIGNATION	UT	CODE	PPHT (€)	ECOPART (€)
025.0016.14	ANGLE RENTRANT D'ETANCH.NATOSSEC -2- 325025	U	5837X.1	21,53	0,01



NATOSSEC

SOLS ET MURS - Bande



	DÉSIGNATION	UT	CODE	PPHT (€)	ECOPART (€)
025.0069.69	BANDE ETANCHEITE NATOSSEC 120X10 LAZER 325010	U	49380.7	92,93	0,01

Le PPHT comprend l'ecopart (€)

DOUCHE

RECEVEUR A CARRELER

NATOSEC
 SOLS ET MURS - Natte

	DÉSIGNATION	UT	CODE	PPHT (€)	ECOPART (€)
025.0100.36	NATTE ETANCH.NATOSEC ROUL.5X1M LAZER 325000	U	5837V.5	133,83	0,01
025.0185.51	NATTE ETANCH.NATOSEC ROUL.10X1M LAZER 325001	U	4938P.9	247,36	0,01

NATOSEC
 SOLS ET MURS - Natte et siphon

	DÉSIGNATION	UT	CODE	PPHT (€)	ECOPART (€)
025.0101.90	NATTE NATOSEC CLASS.50X50+SIPHON GRIL. 325050	U	58388.0	135,87	0,01
025.0108.69	NATTE NATOSEC CLASS.50X50+SIPHON GRIL. 325051	U	5838M.1	135,87	0,01
025.0108.69	NATTE EX.PL.NATOSEC 50X50+SIPHON GRIL. 325052	U	4938T.1	135,87	0,01

PANODUR
 Bonde Rotaflux - A sortie horizontale

	DÉSIGNATION	UT	CODE	PPHT (€)	ECOPART (€)
025.0074.05	SIPHON SOL PANODUR LINEAL SORT/HOR. 350008	U	2107G.3	74,06	0,01

PANODUR LINEAL
 Receveur à carreler avec trou excentré, sans bonde

	DÉSIGNATION	UT	CODE	PPHT (€)	ECOPART (€)
025.0445.00	SOL PANODUR A/CAR. RECT. 180X90 LAZER 340162	U	2888G.8	593,34	0,01

PANODUR LINEAL
 Receveur à carreler avec trou central sans bonde

	DÉSIGNATION	UT	CODE	PPHT (€)	ECOPART (€)
025.0445.00	SOL PANODUR 180X90 TROU CENTRAL LAZER 340142	U	2888E.2	593,34	0,01

DOUCHE

RECEVEUR A CARRELER

PANODUR LINEAL
 Receveur à carreler avec écoulement
 linéaire intégré - Sans bonde

	DÉSIGNATION	UT	CODE	PPHT (€)	ECOPART (€)
025.0556.00	SOL PANODUR LINEAL 90X120 SS BDE LAZER 370056	U	20773.8	741,34	0,01
025.0726.67	SOL PANODUR LINEAL 180X90 SS BDE LAZER 370058	U	2077L.0	968,90	0,01
025.0605.11	SOL PANODUR LINEAL 80X150 SS BDE LAZER 370052	U	2058B.3	806,82	0,01
025.0642.14	SOL PANODUR LINEAL 90X150 SS BDE LAZER 370057	U	2077F.1	856,19	0,01

PANODUR LINEAL
 Barrette de finition - Pour receveur 90 cm de
 large

	DÉSIGNATION	UT	CODE	PPHT (€)	ECOPART (€)
025.0065.32	BARRETTE FINIT.INOX P.LINEAL 90 LAZER 380051	U	72237.1	87,11	0,01

PANODUR LINEAL
 Barrette de finition - Pour receveur 100 cm de
 large

	DÉSIGNATION	UT	CODE	PPHT (€)	ECOPART (€)
025.0067.24	BARRETTE FINIT.INOX P.LINEAL 100 LAZER 380052	U	72237.1	89,66	0,01

PANODUR LINEAL
 Accessoires de pose - Barette

	DÉSIGNATION	UT	CODE	PPHT (€)	ECOPART (€)
025.0061.28	BARRETTE FINIT.INOX LINEAL 59 LAZER 380050	U	96891.7	81,71	0,01
025.0112.68	BARRETTE A CARR.INOX LINEAL 69 LAZER 380071	U	99538.1	150,25	0,01

PANODUR LINEAL
 Bonde

	DÉSIGNATION	UT	CODE	PPHT (€)	ECOPART (€)
025.0074.05	BONDE PANODUR LINEAL SORTIE VERT.LAZER 350009	U	2107K.6	74,06	0,01

Le PPHT comprend l'ecopart (€)

DOUCHE

RECEVEUR A CARRELER



PANODUR SLIM

Receveur prêt à carreler avec siphon Rotaslim et grille carrée - Carré



	DÉSIGNATION	UT	CODE	PPHT (€)	ECOPART (€)
025.0533.81	SOL PANODUR SLIM 90X90 +ROTASLIM LAZER 330187	U	16558.9	711,76	0,01



PANODUR SLIM

Receveur prêt à carreler avec siphon Rotaslim et grille carrée - Rectangulaire



	DÉSIGNATION	UT	CODE	PPHT (€)	ECOPART (€)
025.0643.75	SOL PANODUR SLIM120X090+ROTASLIM LAZER 330190	U	1655N.8	858,34	0,01



ROTAFLUX

Siphon de sol pour receveur à carreler Panodur - Panodur Classic



	DÉSIGNATION	UT	CODE	PPHT (€)	ECOPART (€)
025.0071.44	BONDE ROTAFLUX SORTIE HORIZONTALE.LAZER 350030	U	0934W.6	95,27	0,01
025.0071.44	BONDE ROTAFLUX SORTIE VERTICALE. LAZER 350031	U	0935T.2	95,27	0,01



ROTASLIM



	DÉSIGNATION	UT	CODE	PPHT (€)	ECOPART (€)
025.0062.12	BONDE ROTASLIM SORTIE HORIZONTALE.LAZER 350015	U	1655P.6	82,83	0,01
025.0063.41	BONDE ROTASLIM SORTIE HORIZONTALE.LAZER 350018	U	0980J.4	84,56	0,01



ACCESSOIRES DE POSE

Pour douche à carreler



	DÉSIGNATION	UT	CODE	PPHT (€)	ECOPART (€)
025.0064.87	COLLE ETANCHE NATOCOL 4.25KG LAZER 325031	U	4938S.3	86,50	0,01
025.0037.10	COLLE ETANCHE NATOCOL 1.85KG LAZER 325030	U	5838S.6	49,48	0,01

DOUCHE

RECEVEUR A CARRELER



ACCESSOIRES DE POSE

Pour douche à carreler



	DÉSIGNATION	UT	CODE	PPHT (€)	ECOPART (€)
025.0101.44	PRODUIT D'ETANCHEITE -KIT- LAZER 350090	U	5004F.2	135,26	0,01



ACCESSOIRES DE POSE MURAL



	DÉSIGNATION	UT	CODE	PPHT (€)	ECOPART (€)
025.0013.23	BANDE ARMEE FINITION RL20X125MM LAZER 360114	U	1957L.7	17,65	0,01

**VOTRE
ESPACE PRO,
LA CLÉ DE TOUS
VOS SUCCÈS !**



MON ESPACE PRO
www.richardson.fr



Rendez-vous vers
votre espace pro



Le PPHT comprend l'ecopart (€)

100% Exclusivités Receveurs

Metropolitan
par hidrobox



Essentiel

UPcity
par Doccia Group

Sign
par DURAVIT

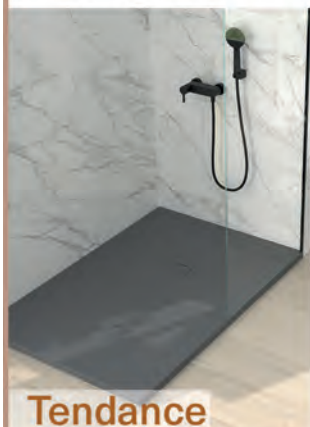

Tendance



Design

Les gammes exclusives,
Le meilleur atout des Pros

- Des prix publics attractifs
- La qualité des grandes marques
- Produits et pièces détachées disponibles rapidement

Retrouvez tous les produits
exclusifs dans nos catalogues !



RICHARDSON

Le PPHT comprend l'ecopart (€)

DOUCHE

PAROI ET PORTE DE DOUCHE



Metropolitan
EXCLUSIVITES RICHARDSON PAR ROTH FRANCE
Porte pivotante - Pivot excentré



	DÉSIGNATION	UT	CODE	PPHT (€)	ECOPART (€)
748.0312.66	PORTE PIV. METRO.2024 80X195 1406001523	U	A07XP.5	391,04	0,21
748.0326.00	PORTE PIV. METRO.2024 90X195 1406001524	U	A07XQ.3	407,71	0,21
748.0346.00	PORTE PIV. METRO.2024 100X195 1406001522	U	A07XR.1	432,71	0,21



Metropolitan
EXCLUSIVITES RICHARDSON PAR ROTH FRANCE
Accès d'angle - Droite - Verre clair



	DÉSIGNATION	UT	CODE	PPHT (€)	ECOPART (€)
748.0246.33	ACCES ANG.DRT METRO.2024 80X195 1406001535	U	A07Y6.1	308,12	0,21
748.0264.66	ACCES ANG.DRT METRO.2024 90X195 1406001537	U	A07Y4.4	331,04	0,21



Metropolitan
EXCLUSIVITES RICHARDSON PAR ROTH FRANCE
Accès d'angle - Gauche - Verre clair



	DÉSIGNATION	UT	CODE	PPHT (€)	ECOPART (€)
748.0246.33	ACCES ANG.GCH METRO.2024 80X195 1406001536	U	A07Y7.9	308,12	0,21
748.0264.66	ACCES ANG.GCH METRO.2024 90X195 1406001538	U	A07YQ.2	331,04	0,21



Metropolitan
EXCLUSIVITES RICHARDSON PAR ROTH FRANCE
Porte 2 battants



	DÉSIGNATION	UT	CODE	PPHT (€)	ECOPART (€)
748.0386.00	PORTE 2 BAT. METRO.2024 80X195 1406001593	U	A07XU.4	482,71	0,21
748.0412.66	PORTE 2 BAT. METRO.2024 90X195 1406001594	U	A07XV.2	516,04	0,21



Metropolitan
EXCLUSIVITES RICHARDSON PAR ROTH FRANCE
Paroi fixe pour porte pivotante à 2 battants et coulissantes - Verre clair - Ep. verre: 6 mm - Montage en angle



	DÉSIGNATION	UT	CODE	PPHT (€)	ECOPART (€)
748.0219.33	PAROI FIXE METRO.2024 70X195 1406001529	U	A07XZ.5	274,37	0,21
748.0232.66	PAROI FIXE METRO.2024 80X195 1406001530	U	A07Y0.4	291,04	0,21
748.0252.66	PAROI FIXE METRO.2024 90X195 1406001531	U	A07Y2.0	316,04	0,21

DOUCHE

PAROI ET PORTE DE DOUCHE



EXCLUSIVITES RICHARDSON PAR ROTH FRANCE
Porte coulissante - 1 élément coulissant + 1 élément fixe



	DÉSIGNATION	UT	CODE	PPHT (€)	ECOPART (€)
748.0432.66	PORTE COUL. METRO.2024 100X195 1406001526	U	A07XW.0	541,04	0,21
748.0466.00	PORTE COUL. METRO.2024 120X195 1406001527	U	A07XX.8	582,71	0,21
748.0526.00	PORTE COUL. METRO.2024 140X195 1406001528	U	A07XY.6	657,71	0,21



EXCLUSIVITES RICHARDSON PAR ROTH FRANCE
Walk-in avec stabilisateur - Verre 8 mm

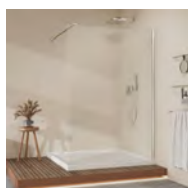

	DÉSIGNATION	UT	CODE	PPHT (€)	ECOPART (€)
748.0266.00	PAROI WALK IN METRO.2024 80X200 1406001543	U	A07YW.9	332,71	0,21
748.0286.00	PAROI WALK IN METRO.2024 90X200 1406001544	U	A07YY.5	357,71	0,21
748.0306.00	PAROI WALK IN METRO.2024 100X200 1406001545	U	A07Z0.3	382,71	0,21
748.0332.66	PAROI WALK IN METRO.2024 120X200 1406001546	U	A07Z2.9	416,04	0,21
748.0379.33	PAROI WALK IN METRO.2024 140X200 1406001547	U	A07Z3.7	474,37	0,21



BATIPANEL
Panneaux de finition d'un habillage bâti-support
- Hauteur 150 cm, Ép. 3 mm - Revêtement de surface résistant - Kit de pose inclus



	DÉSIGNATION	UT	CODE	PPHT (€)	ECOPART (€)
740.0234.40	PANNEAU BATIPANEL 1500X1200 BLANC 1420000291	U	354LD.1	293,34	0,34
740.0280.80	PANNEAU BATIPANEL 1500X1200 GRIS 1420000292	U	354LF.6	351,34	0,34
740.0280.80	PANNEAU BATIPANEL 1500X1200 CHENE 1420000294	U	354LG.4	351,34	0,34

ROBINETTERIE DE DOUCHE



EXCLUSIVITES RICHARDSON PAR NOBILI
Colonne thermostatique apparente



	DÉSIGNATION	UT	CODE	PPHT (€)	ECOPART (€)
748.0363.66	COLONNE DCH.TH.METRO 2.CHR ME85330/31CR	U	287QF.9	454,59	0,01

DOUCHE

ROBINETTERIE DE DOUCHE



EXCLUSIVITES RICHARDSON PAR NOBILI
Mitigeur de douche mural



	DÉSIGNATION	UT	CODE	PPHT (€)	ECOPART (€)
748.0077.93	MITIGEUR DCH.METRO 2 CHR ME112130CR	U	287QH.5	97,42	0,01



EXCLUSIVITES RICHARDSON PAR NOBILI
Mitigeur douche thermostatique



	DÉSIGNATION	UT	CODE	PPHT (€)	ECOPART (€)
748.0127.00	MITIGEUR DCH.TH.METRO 2 CHR ME85330CR	U	287QJ.2	158,76	0,01



EXCLUSIVITES RICHARDSON PAR NOBILI
Flexible pour douchette



	DÉSIGNATION	UT	CODE	PPHT (€)	ECOPART (€)
748.0029.00	FLEXIBLE 150CM METROPOLIAN NOBILI AD135/43CR	U	7765Q.8	29,01	0,01



EXCLUSIVITES RICHARDSON PAR PAINI FRANCE
Mitigeur douche mural - Entraxe 150 + / - 20 mm



	DÉSIGNATION	UT	CODE	PPHT (€)	ECOPART (€)
592.0045.20	MITIGEUR DCH. MURAL EAZY EZCR511	U	37714.3	56,51	0,01
592.0099.12	MITIGEUR DCH MURAL/THERM. C3 EAZY EZCR511TH	U	277W9.8	123,91	0,01



EXCLUSIVITES RICHARDSON PAR NOBILI
Mitigeur douche - Thermostatique mural



	DÉSIGNATION	UT	CODE	PPHT (€)	ECOPART (€)
593.0231.87	MITIGEUR DCH THERM.UPCITY NOIR UPC185530BM	U	200MW.8	309,17	0,01

DOUCHE

ROBINETTERIE DE DOUCHE

**BAULOOP**

Mitigeur douche mural - Cartouche en céramique



DÉSIGNATION	UT	CODE	PPHT (€)	ECOPART (€)
762.0075.09 MITIGEUR DCH BAULOOP 2020 23633001	U	299DT.6	83,45	0,02

**EUROSMART**

Mitigeur douche mural



DÉSIGNATION	UT	CODE	PPHT (€)	ECOPART (€)
762.0105.22 MITIGEUR DCH EUROSMART 2021 GROHE 32172003	U	323SY.4	105,24	0,02

**EUROSMART COSMOPOLITAN**

Mitigeur douche mural



DÉSIGNATION	UT	CODE	PPHT (€)	ECOPART (€)
762.0100.85 MITIGEUR DCH.EUROSMART COSMO. GROHE 32838000	U	4853H.3	112,08	0,02

**GROHTHERM 800**

Mitigeur douche thermostatique mural



DÉSIGNATION	UT	CODE	PPHT (€)	ECOPART (€)
762.0159.90 MITIGEUR DCH THM MURAL GROHTHERM 800 34562000	U	5314T.2	177,69	0,02

**GROHTHERM 1000**

Mitigeur thermostatique



DÉSIGNATION	UT	CODE	PPHT (€)	ECOPART (€)
762.0233.15 MITIGEUR DCH.TH.MURAL GROHTHERM 1000 34818003	U	299DY.5	233,17	0,02

Le PPHT comprend l'ecopart (€)

DOUCHE

ROBINETTERIE DE DOUCHE

hansgrohe

ECOSTAT 1001 CL

Mitigeur douche thermostatique



DÉSIGNATION	UT	CODE	PPHT (€)	ECOPART (€)
765.0187.79 MITIGEUR DCH.TH.ECOST.1001CL H.GROHE 13211000	U	2495A.6	208,67	0,02

hansgrohe

ECOSTAT 1001 CL

Mitigeur douche thermostatique



DÉSIGNATION	UT	CODE	PPHT (€)	ECOPART (€)
765.0242.89 MITIGEUR B/D TH.ECOST.1001CL H.GROHE 13201000	U	2497D.8	269,90	0,02

hansgrohe

TICA

Exclusivité RICHARDSON - Mitigeur de douche



DÉSIGNATION	UT	CODE	PPHT (€)	ECOPART (€)
765.0101.13 MITIGEUR DCH TICA MURAL CHR 14609000	U	319K4.5	126,42	0,01

hansgrohe

TICA

Exclusivité RICHARDSON - Mitigeur thermostatique de douche



DÉSIGNATION	UT	CODE	PPHT (€)	ECOPART (€)
765.0161.33 MITIGEUR THERM. DE DCH TICA CHR 13251000	U	319K6.0	201,67	0,01

hansgrohe

VERNI BLEND

Mitigeur douche - 1 sortie = 1 fonction



DÉSIGNATION	UT	CODE	PPHT (€)	ECOPART (€)
765.0116.12 MITIGEUR DCH VERNIS BLEND NOIR/MAT 71640670	U	344SX.2	129,04	0,02

**BRIVE**

Mitigeur douche mural



DÉSIGNATION	UT	CODE	PPHT (€)	ECOPART (€)
767.0085.28 MITIGEUR DCH.MUR.BRIVE JD E75765-CP	U	8002J.1	106,62	0,02

DOUCHE

ROBINETTERIE DE DOUCHE



BRIVE

Mitigeur douche mural - Mitigeur thermostatique douche mural



	DÉSIGNATION	UT	CODE	PPHT (€)	ECOPART (€)
767.0164.36	MITIGEUR DCH/MURAL THERM BRIVE CHR E24334-CP	U	266A9.7	205,47	0,02



CANDIDE

Mitigeur douche mural - Entraxe 150 mm



	DÉSIGNATION	UT	CODE	PPHT (€)	ECOPART (€)
767.0090.40	MITIGEUR DCH. CANDIDE CHR JD E666-CP	U	00523.1	113,00	



JULY

Mitigeur douche mural



	DÉSIGNATION	UT	CODE	PPHT (€)	ECOPART (€)
767.0089.64	MITIGEUR DCH. MURAL JULY CHR JD E16029-4-CP	U	3266H.6	112,07	0,02



JULY

Mitigeur douche thermostatique mural - Avec limiteur de débit



	DÉSIGNATION	UT	CODE	PPHT (€)	ECOPART (€)
767.0188.76	MITIGEUR DCH. MUR.THERM.JULY CHR JD E8455-CP	U	9140K.0	235,97	0,02

ROBINETTERIE ENCASTREE DE DOUCHE



GROHTHERM

Mitigeur thermostatique de douche - Design carré



	DÉSIGNATION	UT	CODE	PPHT (€)	ECOPART (€)
762.0422.12	FACADE DCH. THER.GROHTHERM CARREE 2S 24079000	U	201FP.8	469,04	0,02

DOUCHE

ROBINETTERIE ENCASTREE DE DOUCHE



GROHTHERM

Mitigeur thermostatique de douche - Design rond



	DÉSIGNATION	UT	CODE	PPHT (€)	ECOPART (€)
762.0422.12	FACADE DCH. THER. GROHTHERM RONDE 2S 24076000	U	201FC.2	469,04	0,02



RAINSHOWER

Bras de douche - A associer à la douche de Tête réf. 28368 ou 27134



	DÉSIGNATION	UT	CODE	PPHT (€)	ECOPART (€)
762.0081.53	BRAS DCH.MUR.RAINSHOWER CHR GROHE 28576000	U	2352A.8	90,61	0,02



RAPIDO T

Corps encastré pour mitigeur thermostatique 3/4"



	DÉSIGNATION	UT	CODE	PPHT (€)	ECOPART (€)
762.0079.68	CORPS ENC. UNIV.1/2 RAPIDO SMARTBOX 35604000	U	299DV.1	79,70	0,02



RELEXA

Coude à encastrer - Relexa ultra



	DÉSIGNATION	UT	CODE	PPHT (€)	ECOPART (€)
762.0031.42	COUDE RELEXA NEUTRAL ENCAST. 28628000	U	9512V.9	34,93	0,02



TEMPESTA 210

Douche de tête



	DÉSIGNATION	UT	CODE	PPHT (€)	ECOPART (€)
762.0078.30	DOUCHE DE TETE NTEMPESTA 210 GROHE 26408000	U	175U4.7	87,00	

Le PPHT comprend l'ecopart (€)

DOUCHE

ROBINETTERIE ENCASTREE DE DOUCHE

hansgrohe

AXOR CITTERIO

Bras de douche



	DÉSIGNATION	UT	CODE	PPHT (€)	ECOPART (€)
765.0095.75	BRAS DCH. 389 MM H.GROHE 27413000	U	13271.5	106,41	0,02

hansgrohe

FIXFIT

Coude de raccordement - pour tout flexible en 1/2



	DÉSIGNATION	UT	CODE	PPHT (€)	ECOPART (€)
765.0035.66	COUDE RACC.FIXFIT CHR H.GROHE 27454000	U	08595.1	39,64	0,02

hansgrohe

FIXFIT

Coude de raccordement - Pour les flexibles avec écrou conique



	DÉSIGNATION	UT	CODE	PPHT (€)	ECOPART (€)
765.0098.23	COUDE FIXFIT PORTER S H.GROHE 26888000	U	36817.4	98,25	0,02

hansgrohe

FOCUS

Set de finition pour mitigeur bain-douche encastré - Avec limiteur de température réglable individuellement



	DÉSIGNATION	UT	CODE	PPHT (€)	ECOPART (€)
765.0161.95	SET FINIT.MIT.BD FOCUS CHR H.GROHE 31945000	U	67391.5	179,97	0,02

hansgrohe

IBOX UNIVERSAL

Corps encastrement douche-bain/douche - mécanique et thermostatique



	DÉSIGNATION	UT	CODE	PPHT (€)	ECOPART (€)
765.0110.02	CORPS ENC.IBOX UNIVERSEL H.GROHE 01800180	U	12948.6	122,26	0,02

hansgrohe

RAINDANCE

Set de finition



	DÉSIGNATION	UT	CODE	PPHT (€)	ECOPART (€)
765.0665.15	SET FINIT.MIT.TH.SHOW.SELECT H.GROHE 15763000	U	26450.5	739,07	0,02

Le PPHT comprend l'ecopart (€)

DOUCHE

ROBINETTERIE ENCASTREE DE DOUCHE

hansgrohe

SET DE FINITION

2 sorties = 2 fonctions



	DÉSIGNATION	UT	CODE	PPHT (€)	ECOPART (€)
765.0796.55	SET FINIT.MIT.TH.SHOW.SELECT H.GROHE 15765000	U	5501U.2	885,07	0,02

Nicoll
by aliaxis

DOUCHE DE TETE



	DÉSIGNATION	UT	CODE	PPHT (€)	ECOPART (€)
757.0079.09	POMME DCH.LAIT.CHR 120 1/2 120AG 0421005	U	72613.3	105,47	0,02
757.0044.08	POMME DCH.S.GALERIE 80SG 1/2 80SG 0421002	U	66894.7	58,80	0,02

VIDAGE ET SIPHON DE DOUCHE

UPcity
Collections Exclusives

EXCLUSIVITES RICHARDSON PAR NOBILI

Bonde Clic-Clac



	DÉSIGNATION	UT	CODE	PPHT (€)
593.0047.25	BONDE CLIC-CLAC UPCITY LAIT/CHR AV00110/11CR	U	201HU.5	63,00

UPcity
Collections Exclusives

EXCLUSIVITES RICHARDSON PAR NOBILI

Bonde receveur



	DÉSIGNATION	UT	CODE	PPHT (€)
593.0030.62	BONDE RECEVEUR UPCITY NOIR/MAT AV111/13BM	U	201HZ.6	40,83

TEKNIK
Collections Exclusives

EXCLUSIVITES RICHARDSON PAR CGS

Bonde de douche - Universelle 2 en 1



	DÉSIGNATION	UT	CODE	PPHT (€)	ECOPART (€)
000.0024.80	BONDE DCH TEKNIK CHR ST6590.01N	U	275D8.7	24,81	0,01
000.0048.70	BONDE DCH TEKNIK NOIR MAT ST6590.43N	U	275D9.5	48,71	0,01

DOUCHE

VIDAGE ET SIPHON DE DOUCHE



SQUARE DRAIN

Siphon - A encastrer avec membrane d'étanchéité



	DÉSIGNATION	UT	CODE	PPHT (€)
025.0153.75	SIPHON SQ.DRAIN NATTE ETANCH.15CM ID4MSQ0150	U	3345S.2	205,00



SQUARE DRAIN

Grille - à carreler - Carré

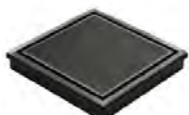

	DÉSIGNATION	UT	CODE	PPHT (€)
025.0060.75	GRILLE A CARR.PLANO SQ.DRAIN 15CM IDROSQ0150A	U	3346S.1	81,00

GEBERIT

UNIFLEX

Bonde - ø 90 mm - Avec set de finition



	DÉSIGNATION	UT	CODE	PPHT (€)	ECOPART (€)
716.0069.61	BONDE P/REC. SIPHOIDE D90 GEBERIT 150552211	U	9478K.2	87,03	0,02

hansgrohe

RAINDRAIN SPOT

Siphon de douche 150/150



	DÉSIGNATION	UT	CODE	PPHT (€)	ECOPART (€)
765.0125.95	SIPHON DCH 15X15CM RAINDRAIN SPOT 56055800	U	336DU.3	125,97	0,02



BONDE

Plastique - ø 60 mm - Sortie horizontale - A grille



	DÉSIGNATION	UT	CODE	PPHT (€)	ECOPART (€)
757.0010.04	BONDE DCH.D60 A VISSER/A COLLER 580 0205001	U	40633.0	13,41	0,02



BONDE

Plastique - ø 60 mm - Sortie verticale - A grille



	DÉSIGNATION	UT	CODE	PPHT (€)	ECOPART (€)
757.0010.40	BONDE DCH.D60 VERTICALE 590 0205049	U	10170.9	13,88	0,02

DOUCHE

VIDAGE ET SIPHON DE DOUCHE



BONDE

Plastique - ø 90 mm - Sortie horizontale - A capot



	DÉSIGNATION	UT	CODE	PPHT (€)	ECOPART (€)
757.0033.86	BONDE DCH.D90 SIPHOIDE SH.+ROSACE 690 0205070	U	47077.3	45,17	0,02



BONDE

Plastique - ø 90 mm - Sortie verticale - A capot



	DÉSIGNATION	UT	CODE	PPHT (€)	ECOPART (€)
757.0033.86	BONDE DCH.D90 1 1/2 SV. 790 0205110	U	54652.3	45,17	0,02



BONDE

Plastique - ø 90 mm - Sortie horizontale - A grille



	DÉSIGNATION	UT	CODE	PPHT (€)	ECOPART (€)
757.0025.18	BONDE SIPHOIDE HORIZ.D90 GR.INOX 695 0205075	U	01535.4	33,59	0,02



BONDE

Plastique - ø 90 mm - Sortie verticale - A grille



	DÉSIGNATION	UT	CODE	PPHT (€)	ECOPART (€)
757.0032.04	BONDE DCH.D90 1 1/2 SV.AV.GRILLE 795 0205115	U	75656.9	42,74	0,02



TURBO FLOW

Bonde à grand débit plastique - Sortie horizontale



	DÉSIGNATION	UT	CODE	PPHT (€)	ECOPART (€)
757.0039.95	BONDE DCH.TURBOFLOW D60 CHR TB60 0205243	U	15034.2	53,29	0,02



TURBO FLOW XS

Bonde pour receveur Ø 90 cm - très haut débit - Sortie horizontale



	DÉSIGNATION	UT	CODE	PPHT (€)	ECOPART (€)
757.0067.25	BONDE DCH.TURBOFLOW XS TBXS 90 0205800	U	8837F.9	89,69	0,02

Le PPHT comprend l'ecopart (€)

DOUCHE

VIDAGE ET SIPHON DE DOUCHE

Nicoll
by allaxis

TURBOFLOW®2

Bonde à très haut débit (43 L/min) -
ø 90 mm - Sortie horizontale



	DÉSIGNATION	UT	CODE	PPHT (€)	ECOPART (€)
757.0048.73	BONDE DCH.TURBOFLOW2 D90 CHR TB21 0205700	U	65265.1	64,99	0,02

SFA
FRCLIP
Agitateur d'eau

SANIDOUCHE+

Pompe de relevage pour receveur de
douche classique - Pour douche et
lavabo



	DÉSIGNATION	UT	CODE	PPHT (€)	ECOPART (€)
717.0553.52	POMPE DE RELEVAGE SANIDOUCHE+ SFA D2UPSTD	U	31651.3	692,15	0,25

**wirquin
PRO**

BONDE DE DOUCHE

Membrane Bonde Slim - Pour douche



	DÉSIGNATION	UT	CODE	PPHT (€)	ECOPART (€)
714.0014.91	CARTOUCHE MEMBRANE SLIM+ 30723382	U	354K5.9	14,93	0,02

**wirquin
PRO**

BOUCHON UNIVERSEL

	DÉSIGNATION	UT	CODE	PPHT (€)	ECOPART (€)
714.0004.28	CLOCHE GODET WIRQUIN 30719156	U	208YN.2	4,28	

**wirquin
PRO**

SLIM

Bonde de douche ø 90mm - Pour
receveur extra-plat



	DÉSIGNATION	UT	CODE	PPHT (€)	ECOPART (€)
759.0045.05	BONDE DCH.SLIM MEMBRANE D90 WIRQUIN 30719686	U	0857N.6	56,33	0,02

DOUCHE

VIDAGE ET SIPHON DE DOUCHE

**wirquin
PRO**

SLIM

Siphon de douche - Pour receveur
extra-plat



	DÉSIGNATION	UT	CODE	PPHT (€)	ECOPART (€)
714.0046.12	SIPHON DCH.SLIM MEMBR.D40/43 WIRQUIN 30718662	U	4100K.9	57,67	0,02

ACCESSOIRES DE DOUCHE

Jacob Delafon
PARIS

FLIGHT

Kit de réhausse sans tablier



	DÉSIGNATION	UT	CODE	PPHT (€)	ECOPART (€)
704.0059.96	REHAUSSE HT.16.5CM S.TABL.-KIT- JD 9-E6247000	U	4615E.8	74,97	0,02

LAZER

STABILIBAC

Pieds pour receveur



	DÉSIGNATION	UT	CODE	PPHT (€)	ECOPART (€)
025.0021.32	PIED P/REC.DCH STABILIBAC JEU 4 LAZER 150620	U	57571.2	28,44	0,01

LAZER

STABILIBAC

Rallonges Stabilibac



	DÉSIGNATION	UT	CODE	PPHT (€)	ECOPART (€)
025.0009.17	RALLONGE STABILIBAC H36MM -LOT4- LAZER 150625	U	5020E.4	12,24	0,01

Pour plus d'infos,
consultez
le CAHIER TECHNIQUE
page 14

100% Exclusivités

TEKNIK

2
ANS
GARANTIE

par **ANQUIER**

PLATINE DE FIXATION



- 3 plaques en 1 :
entraxe 150, 60 et mono
- Pour tube PER à
glissement ou à sertir,
DN12 ou DN16
- Pour tube multicouche à
sertir DN16
- Visitable
- Livré avec kit de
fixation et bouchons
de protection



Uniquement chez
RICHARDSON

HYDROTHERAPIE

COLONNE DE DOUCHE

UPcity
Collections
Exclusives

EXCLUSIVITES RICHARDSON PAR NOBILI
Colonne de douche - Thermostatique standard



	DÉSIGNATION	UT	CODE	PPHT (€)	ECOPART (€)
593.0488.12	COLONNE DCH THERM. UPCITY CHR UPCI94030/32CR	U	200L5.3	650,84	0,01
593.0697.50	COLONNE DCH THERM. UPCITY NOIR UPCI94030/32BM	U	200L6.1	930,01	0,01



EUPHORIA SYSTEM
310 - Colonne de douche thermostatique apparente



	DÉSIGNATION	UT	CODE	PPHT (€)	ECOPART (€)
762.0606.46	COLONNE DCH.TH.EUPHORIA 310 GROHE 26384002	U	287HN.7	673,86	0,02



TEMPESTA COSMOPOLITAN
System 250 Cube



	DÉSIGNATION	UT	CODE	PPHT (€)	ECOPART (€)
762.0476.12	COLONNE DCH.TH.TEMPESTA 250 CUBE 26690000	U	287HP.5	529,04	0,02



COPIE DE TEMPESTA SYSTEM 250 CUBE
Colonne de douche



	DÉSIGNATION	UT	CODE	PPHT (€)	ECOPART (€)
762.0452.29	COLONNE DCH TEMPESTA 250 ROND 26671001	U	427L8.6	502,55	

hansgrohe

CROMA 280 SHOWERPIPE
Colonne de douche - Showerpipe thermostatique



	DÉSIGNATION	UT	CODE	PPHT (€)	ECOPART (€)
765.0761.91	COLONNE SHOWERPIPE CROMA S280 HGROHE 26790000	U	6249S.2	846,59	0,02

Le PPHT comprend l'ecopart (€)

HYDROTHERAPIE

COLONNE DE DOUCHE

hansgrohe

CROMETTA E240

Colonne douche



	DÉSIGNATION	UT	CODE	PPHT (€)	ECOPART (€)
765.0508.24	COLONNE DCH.SHOWERPIPE CROMETTA E240 27271000	U	16049.9	564,73	0,02
765.0508.24	COLONNE SHOWERP. CROMET/E240 ECO CHR 27281000	U	99256.8	564,73	0,02

hansgrohe

CROMETTA E240

Pack douche encastrée - Douche de tête carrée



	DÉSIGNATION	UT	CODE	PPHT (€)	ECOPART (€)
765.0853.60	PACK DCH THE. ENC. CROMETTA E240 CHR 26998000	U	285K0.6	948,46	0,02

hansgrohe

CROMETTA S240

Colonne douche



	DÉSIGNATION	UT	CODE	PPHT (€)	ECOPART (€)
765.0497.02	COLONNE DCH.CROMETTA S240 H.GROHE 27267000	U	6248N.1	552,26	0,02

hansgrohe

CROMETTA S240

Colonne douche



	DÉSIGNATION	UT	CODE	PPHT (€)	ECOPART (€)
765.0699.79	COLONNE B/D CROMETTA S240 1J H.GROHE 27320000	U	6456H.9	777,56	0,02
765.0497.02	SHOWERPIPE S240 1J CROMET. ECOS. CHR 27268000	U	7478H.1	552,26	0,02

hansgrohe

TICA

Une exclusivité RICHARDSON - Colonne de douche thermostatique



	DÉSIGNATION	UT	CODE	PPHT (€)	ECOPART (€)
765.0661.66	COLONNE DCH 280 TICA CHR 26894000	U	319KH.6	827,09	0,01

hansgrohe

VERNIS BLEND

Colonne de douche 200 - 1jet avec mitigeur thermostatique



	DÉSIGNATION	UT	CODE	PPHT (€)	ECOPART (€)
765.0451.58	COLONNE SHOWERPIPE VERNIS 200 RONDE 26276000	U	325W8.7	451,60	0,02
765.0569.40	COLONNE 200 1JET VERN/BLEND TH. NOIR 26276670	U	336AN.9	632,68	0,01

Le PPHT comprend l'ecopart (€)

HYDROTHERAPIE

COLONNE DE DOUCHE

hansgrohe

VERNIS BLEND

Colonne de douche 200 - jet EcoSmart 9 l/min avec mitigeur thermostatique de douche



	DÉSIGNATION	UT	CODE	PPHT (€)	ECOPART (€)
765.0406.42	VERNIS BLEND SHOWERPIPE 200 1J TH CH 26089000	U	350ZU.8	451,60	0,02

hansgrohe

VERNIS SHAPE

Colonne de douche 230 - 1jet avec mitigeur thermostatique



	DÉSIGNATION	UT	CODE	PPHT (€)	ECOPART (€)
765.0462.90	COLONNE 230 1JET VERN/SHAPE A/MIT.TH 26286000	U	326BW.2	462,92	0,02

hansgrohe

VERNIS SHAPE

Colonne de douche 230 - 1jet EcoSmart 9l/min avec mitigeur thermostatique



	DÉSIGNATION	UT	CODE	PPHT (€)	ECOPART (€)
765.0416.61	SHOWERPIPE 230 ECOSMART VERNIS SHAPE 26097000	U	350ZT.1	462,92	0,02

Jacob Delafon
1841

BRIVE

Colonne de douche - Mitigeur thermostatique

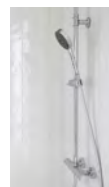

	DÉSIGNATION	UT	CODE	PPHT (€)	ECOPART (€)
767.0387.80	COLONNE DCH BRIVE 2 THERM. E24322-CP	U	269DQ.5	484,77	0,02

BARRE DE DOUCHE

eazy Collections Exclusives

EXCLUSIVITES RICHARDSON PAR PAINI FRANCE

Barre douche complète



	DÉSIGNATION	UT	CODE	PPHT (€)	ECOPART (€)
592.0046.48	BARRE DCH. CPLTE EAZY EZ525	U	3771M.5	58,11	0,01

HYDROTHERAPIE

BARRE DE DOUCHE



EXCLUSIVITES RICHARDSON PAR NOBILI

Barre de douche complète



	DÉSIGNATION	UT	CODE	PPHT (€)	ECOPART (€)
593.0131.25	BARRE DCH COMP.UPCITY CHR AD00140/54CR	U	200N1.0	175,01	0,01



TEMPESTA 100

Barre de douche - Ensemble douche complet 1 jet



	DÉSIGNATION	UT	CODE	PPHT (€)	ECOPART (€)
762.0047.79	ENSEMBLE DCH 600 NTEMPESTA 100 I 27853001	U	4471V.9	53,12	0,02



TEMPESTA 100

Barre de douche - Ensemble douche complet 2 jets



	DÉSIGNATION	UT	CODE	PPHT (€)	ECOPART (€)
762.0056.96	ENSEMBLE DCH COMPL. TEMPESTA 100 II 27598001	U	4454Q.1	63,31	0,02
762.0057.04	SET BARRE DCH NTEMPESTA II 2JETS 26162001	U	8749W.4	63,40	0,02



TEMPESTA 100

Barre de douche - Ensemble douche mural 2 jets



	DÉSIGNATION	UT	CODE	PPHT (€)	ECOPART (€)
762.0035.78	ENSEMBLE DCH TEMPESTA 100 2JETS 26164001	U	8505W.8	39,78	0,02

hansgrohe

CROMA

Barre de douche complète - Croma Select E 110 Vario - Barre Unica'C 65 cm



	DÉSIGNATION	UT	CODE	PPHT (€)	ECOPART (€)
765.0132.43	SET CROMA SELECT E 100 VARIO H.GROHE 26586400	U	5504I.1	147,16	0,02

HYDROTHERAPIE

BARRE DE DOUCHE

hansgrohe

CROMA 100

Unica'C - Barre de douche complète



	DÉSIGNATION	UT	CODE	PPHT (€)	ECOPART (€)
765.0106.96	BARRE DCH.CPLT.CROMA100VARIO H.GROHE 27772000	U	0216G.5	118,86	0,02

hansgrohe

CROMA SELECT S

Combi - Croma Select S Vario 0,65m/ECostat Comfort



	DÉSIGNATION	UT	CODE	PPHT (€)	ECOPART (€)
765.0325.56	ENSEMBLE DCH.TH.CROMA SELECT S VARIO H.GROHE 27013400	U	4656R.5	361,75	0,02

hansgrohe

CROMETTA

Barre de douche complète - Crometta 85 Vario/ Unica'Crometta



	DÉSIGNATION	UT	CODE	PPHT (€)	ECOPART (€)
765.0063.15	SET DCH.CROMETTA/VARIO/UNICA H.GROHE 26553400	U	2496Y.8	70,19	0,02

hansgrohe

CROMETTA

Barre de douche complète - Crometta - Unica'Croma



	DÉSIGNATION	UT	CODE	PPHT (€)	ECOPART (€)
765.0057.04	SET DCH. CROMETTA 1J UNICA H.GROHE 26533400	U	6826S.3	63,40	0,02

hansgrohe

CROMETTA

Garniture de douche - Crometta - Porter'S



	DÉSIGNATION	UT	CODE	PPHT (€)	ECOPART (€)
765.0043.79	SET DCH PORTER S CROMETTA H.GROHE 26567400	U	6246R.7	48,68	0,02

hansgrohe

TICA

Exclusivité RICHARDSON - Barre de douche



	DÉSIGNATION	UT	CODE	PPHT (€)	ECOPART (€)
765.0049.93	BARRE DCH TICA COMPL.UNICA 65CM CHR 26668400	U	319K8.6	62,42	0,01

Le PPHT comprend l'ecopart (€)

HYDROTHERAPIE

BARRE DE DOUCHE

hansgrohe

VERNIS BLEND

Barre de douche Unica 65 cm



	DÉSIGNATION	UT	CODE	PPHT (€)	ECOPART (€)
765.0142.80	SET DCH VERN/BLEND VARIO/UNICA N.MAT 26422670	U	335JK.8	142,82	0,02

hansgrohe

VERNIS BLEND

Bras de douche - M 1/2" 240 mm



	DÉSIGNATION	UT	CODE	PPHT (€)	ECOPART (€)
765.0050.93	BRAS DE DCH VERNIS BLEND CHR HGRÖHE 27809000	U	350B7.2	56,61	0,02

hansgrohe

VERNIS SHAPE

Bras de douche - M 1/2" 240 mm



	DÉSIGNATION	UT	CODE	PPHT (€)	ECOPART (€)
765.0056.59	BRAS DE DCH VERNIS SHAPE CHR HGRÖHE 26405000	U	353N2.5	56,61	0,02



BASIC1

Douchette 2 jets + flexible 1,75 m



	DÉSIGNATION	UT	CODE	PPHT (€)	ECOPART (€)
767.0046.60	DOUCHE+SUPPORT MUR.BASIC1 2JETS JD E14326-CP	U	04484.2	58,27	0,02



ECO 1

Barre de douche complète



	DÉSIGNATION	UT	CODE	PPHT (€)	ECOPART (€)
768.0042.40	BARRE DCH.CPLTE 1J.ECO1 60CM CHR PF 323A	U	2763C.7	53,00	



ECO 1

Garniture de douche

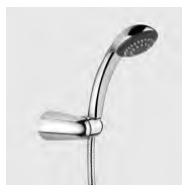

	DÉSIGNATION	UT	CODE	PPHT (€)	ECOPART (€)
768.0022.40	GARNITURE DCH.MUR.1J.DUPLX ECO1 CHR PF 321A	U	1399C.1	28,00	

Le PPHT comprend l'ecopart (€)

HYDROTHERAPIE

BARRE DE DOUCHE



ECO 2

Garniture de douche

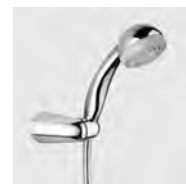

	DÉSIGNATION	UT	CODE	PPHT (€)	ECOPART (€)
768.0023.20	GARNITURE DCH.MUR.2J.DUPLX ECO2 CHR PF 322A	U	0184V.5	29,00	

DOUCHETTE



EXCLUSIVITES RICHARDSON PAR PAINI FRANCE

Douchette



	DÉSIGNATION	UT	CODE	PPHT (€)	ECOPART (€)
592.0016.40	DOUCHETTE 3 JETS EAZY EZ259	U	37725.9	20,51	0,01



EXCLUSIVITES RICHARDSON PAR PAINI FRANCE

Flexible



	DÉSIGNATION	UT	CODE	PPHT (€)	ECOPART (€)
592.0015.12	FLEXIBLE 1,75M EAZY EZ175	U	37726.7	18,91	0,01



EXCLUSIVITES RICHARDSON PAR NOBILI

Douchette ronde



	DÉSIGNATION	UT	CODE	PPHT (€)	ECOPART (€)
593.0061.88	DOUCHETTE RONDE UPCITY CHR RD0142/128CR	U	200N3.6	82,51	0,01



EXCLUSIVITES RICHARDSON PAR FIMA CARLO FRATTINI

Douche de tête carré



	DÉSIGNATION	UT	CODE	PPHT (€)	ECOPART (€)
593.0439.16	DOUCHE TETE CARRE 30X30 SIGN LA/CHR F2216/2CR	U	289CK.4	439,17	0,01

HYDROTHERAPIE

DOUCHETTE



NOUVELLE TEMPESTA

Cosmopolitan 100 - Douchette à main - Sans support de douche



	DÉSIGNATION	UT	CODE	PPHT (€)	ECOPART (€)
762.0019.13	DOUCHETTE TEMPESTA 100 1 JET 27852001	U	8919D.5	21,27	0,02



TEMPESTA 100

Douchette à main - SpeedClean : procédé anti-calcaire - Avec régulateur de débit



	DÉSIGNATION	UT	CODE	PPHT (€)	ECOPART (€)
762.0024.05	DOUCHETTE A MAIN NTEMPESTA II 26161001	U	8507Y.2	26,74	0,02



TEMPESTA 100

Douchette à main - SpeedClean : procédé anti-calcaire - Avec régulateur de débit



	DÉSIGNATION	UT	CODE	PPHT (€)	ECOPART (€)
762.0024.17	DOUCHETTE A MAIN TEMPESTA 100 II 27597001	U	4411M.9	26,87	0,02

hansgrohe

CROMA

Douchette à main - Select E Vario



	DÉSIGNATION	UT	CODE	PPHT (€)	ECOPART (€)
765.0056.03	DOUCHETTE CROMA SELE.E VARIO H.GROHE 26812400	U	4658F.4	62,27	0,02

hansgrohe

CROMA 100

Douchette



	DÉSIGNATION	UT	CODE	PPHT (€)	ECOPART (€)
765.0042.78	DOUCHETTE 4J.CROMA 100 VARIO H.GROHE 28535000	U	0250D.9	47,55	0,02

hansgrohe

CROMA 100

Garniture de douche



	DÉSIGNATION	UT	CODE	PPHT (€)	ECOPART (€)
765.0075.90	SET CROMA100 VARIO/PORTER S H.GROHE 27594000	U	0248J.2	84,33	

HYDROTHERAPIE

DOUCHETTE

hansgrohe

CROMA 110

Douchette à main - Select S Multi



	DÉSIGNATION	UT	CODE	PPHT (€)	ECOPART (€)
765.0076.39	DOUCHETTE 3J.CROMASEL.S MULTIH.GROHE 26800400	U	4658M.1	84,90	0,02

hansgrohe

CROMA 110

Douchette à main - Select S Vario



	DÉSIGNATION	UT	CODE	PPHT (€)	ECOPART (€)
765.0056.03	DOUCHETTE CROMA SELE.S VARIO H.GROHE 26802400	U	4658N.9	62,27	0,02

hansgrohe

CROMA 110

Set de douche - Select S 110 Vario



	DÉSIGNATION	UT	CODE	PPHT (€)	ECOPART (€)
765.0090.66	GARNITURE DCH.CROMA SELECT S H.GROHE 26411400	U	6160W.8	100,75	0,02

hansgrohe

CROMETTA

Douchette



	DÉSIGNATION	UT	CODE	PPHT (€)	ECOPART (€)
765.0022.41	DOUCHETTE CROMETTA BLC/CHR H.GROHE 26331400	U	6244C.7	24,92	0,02

hansgrohe

CROMETTA 85

Vario - Douchette à main



	DÉSIGNATION	UT	CODE	PPHT (€)	ECOPART (€)
765.0025.46	DOUCHETTE CROMETTA VARIO BLC H.GROHE 26330400	U	6245L.8	28,31	0,02

hansgrohe

CROMETTA S240

Douche de tête



	DÉSIGNATION	UT	CODE	PPHT (€)	ECOPART (€)
765.0235.31	DOUCHE TETE CROMETTA S240 H.GROHE 26723000	U	6250H.7	261,47	0,02

Le PPHT comprend l'ecopart (€)

HYDROTHERAPIE

DOUCHETTE

hansgrohe

RAINANCE

Select E 150 - Douchette à main - Ronde
ø 15 cm



	DÉSIGNATION	UT	CODE	PPHT (€)	ECOPART (€)
765.0104.92	DOUCHETTE 3J.RAIND.SELECT120 H.GROHE 26530000	U	1843V.6	116,60	0,02

hansgrohe

RAINANCE SELECT S 120

Set douchette



	DÉSIGNATION	UT	CODE	PPHT (€)	ECOPART (€)
765.0140.56	SET PORTER RAINANCE SELECT S 120 27668000	U	209PL.3	156,20	0,02

hansgrohe

TICA

Exclusivité RICHARDSON - Set douchette à main



	DÉSIGNATION	UT	CODE	PPHT (€)	ECOPART (€)
765.0037.60	SET DCH PORTER TICA CHR 26839400	U	319K9.4	47,01	0,01

hansgrohe

VERNIS BLEND

Douche de tête 200 1jet



	DÉSIGNATION	UT	CODE	PPHT (€)	ECOPART (€)
765.0106.96	DOUCHE DE TETE 200 1J VERNIS BLEND 26271000	U	350B8.0	118,86	0,02



ECO 1

Douchette 1 jet



	DÉSIGNATION	UT	CODE	PPHT (€)	ECOPART (€)
768.0011.20	DOUCHETTE 1J. ECO1 ANTICALCAIRE CHR PF 327A	U	18023.2	14,00	

FLEXIBLE DE DOUCHE



EXCLUSIVITES RICHARDSON PAR NOBILI

Flexible de douche



	DÉSIGNATION	UT	CODE	PPHT (€)	ECOPART (€)
593.0032.87	FLEXIBLE UPCITY NOIR RFX135/57BM	U	200NG.7	43,84	0,01

Le PPHT comprend l'ecopart (€)

HYDROTHERAPIE

FLEXIBLE DE DOUCHE



ROTAFLEX TWISTSTOP

Flexible de douche



	DÉSIGNATION	UT	CODE	PPHT (€)	ECOPART (€)
762.0025.99	FLEXIBLE DCHE TWISTFREE 1500 SILVERF 28364001	U	412PN.9	26,01	0,02
999.0029.22	FLEXIBLE DCHE TWISTFREE 1750 SILVERF 28388001	U	412PP.7	29,24	0,02

hansgrohe

METAFLEX

Flexible - Souple et solide avec 1 écrou conique
1/2-1/2



	DÉSIGNATION	UT	CODE	PPHT (€)	ECOPART (€)
765.0016.30	FLEXIBLE METAFLEX 1M60 CHR H.GROHE 28266000	U	94436.3	18,13	0,02

hansgrohe

ISIFLEX

Flexible de douche - Métal lisse - Anti-torsion



	DÉSIGNATION	UT	CODE	PPHT (€)	ECOPART (€)
765.0030.56	FLEXIBLE ISIFLEX 1M60 CHR H.GROHE 28276000	U	94439.7	33,98	0,02
765.0032.60	FLEXIBLE ISIFLEX 2M00 CHR H.GROHE 28274000	U	94437.1	36,24	0,02



FLEXIBLE LAITON CHROME SIMPLE AGRAFAGE

Écrou conique 1/2-1/2



	DÉSIGNATION	UT	CODE	PPHT (€)	ECOPART (€)
757.0023.54	FLEXIBLE FLEXIFOR 1M50 1/2 CHR 0407041	U	35678.2	31,40	0,02
757.0036.14	FLEXIBLE ECROU CONIQUE 2M00 1/2 CHR 0407049	U	28970.2	48,21	0,02



FLEXIBLE LAITON CHROME DOUBLE AGRAFAGE

Flexifor - démontable écrou conique 1/2-1/2



	DÉSIGNATION	UT	CODE	PPHT (€)	ECOPART (€)
757.0068.98	FLEXIBLE ECROU CONIQUE 2M00 1/2 FOR 0407225	U	56492.2	91,99	0,02

HYDROTHERAPIE

ACCESSOIRES ET SUPPORTS DE DOUCHE



EXCLUSIVITES RICHARDSON PAR NOBILI

Support douchette



	DÉSIGNATION	UT	CODE	PPHT (€)	ECOPART (€)
593.0024.25	SUPPORT DCHTTE UPCITY CHR AD147/4CR	U	29247.4	32,34	0,01

hansgrohe

PORTER'S

Support mural



	DÉSIGNATION	UT	CODE	PPHT (€)	ECOPART (€)
765.0029.54	SUPPORT MUR.PORTER'S CHR H.GROHE 28331000	U	5239B.8	32,84	0,02

hansgrohe

PORTER FIXFIT E



	DÉSIGNATION	UT	CODE	PPHT (€)	ECOPART (€)
765.0098.23	COUDE FIXFIT PORTER E CHR 26889000	U	37292.4	98,25	0,02

hansgrohe

SUPPORT

Support mural - pour flexible à embout conique normalisé et toute douchette



	DÉSIGNATION	UT	CODE	PPHT (€)	ECOPART (€)
765.0026.49	SUPPORT MUR.PORTER'C CHR H.GROHE 27521000	U	17757.6	29,45	0,02



SUPPORT DE DOUCHE

Sur robinetterie



	DÉSIGNATION	UT	CODE	PPHT (€)	ECOPART (€)
757.0017.51	SUPPORT TELEPHONE+ECROU 1/2 CHR 860 0309006	U	05952.7	17,53	0,02



SUPPORT DE DOUCHE

Sur robinetterie



	DÉSIGNATION	UT	CODE	PPHT (€)	ECOPART (€)
757.0016.20	SUPPORT DCH PAR DESSOUS CHR 985 0309020	U	4194A.6	16,22	0,02

BAIGNOIRE

BAIGNOIRE EN MATERIAU DE SYNTHESE



AXESS

Baignoire rectangulaire en Toplax®
- Vidage centré sur la largeur - Pieds en métal réglables



	DÉSIGNATION	UT	CODE	PPHT (€)	ECOPART (€)
705.0173.60	BAIGN RECT AXESS 160X70 245719	U	354B5.8	218,50	1,50
705.0173.60	BAIGN RECT AXESS 170X70 245721	U	354B6.6	218,50	1,50

J+0 100% Dispo



L'atout LIBRE-SERVICE

- Un large choix de produits
- Tous les produits de ce catalogue à votre disposition
- Une équipe à votre service

Le PPHT comprend l'ecopart (€)

100% Exclusivités

TEKNIK

par **CGS** groupe NOBILIS
PERFORMANCES D'ACQUA

3 ANS GARANTIE

VIDAGES & SIPHONS

Lavabo



Douche



Baignoire



2 finitions :
chromé et noir mat

Laiton :
qualité supérieure

Uniquement chez
RICHARDSON

Le PPHT comprend l'ecopart (€)

BAIGNOIRE

BAIGNOIRE ACRYLIQUE

Jacob Delafon
PARIS

CORVETTE

Baignoire rectangulaire



	DÉSIGNATION	UT	CODE	PPHT (€)	ECOPART (€)
527.0179.80	BAIGN.CORVETTE 3 150X70CM BLC JD E60904-00	U	3266J.3	225,42	0,67
527.0179.80	BAIGN.CORVETTE 3 160X70CM BLC JD E60903-00	U	3266K.1	225,42	0,67
527.0179.80	BAIGN.CORVETTE 3 170X70CM BLC JD E60902-00	U	3266L.9	225,42	0,67
704.0179.80	BAIGN.CORVETTE 3 170X75CM BLC JD E60901-00	U	3267O.2	225,42	0,67
704.0223.20	BAIGN.CORVETTE 3 180X80CM BLC JD E60900-00	U	3267I.0	279,67	0,67
704.0223.20	BAIGN.CORVETTE 3 170X80 BLC JD E60905-00	U	0001N.1	279,67	0,67



NOVELLINI

CALOS 2.0

Baignoire rectangulaire - A encastrer



	DÉSIGNATION	UT	CODE	PPHT (€)	ECOPART (€)
740.0349.60	BAIGN. A ENC. CALOS 2 160X70 BLC C2F16070-A	U	207NQ.5	437,67	0,67
740.0349.60	BAIGN.ENC. CALOS 2+PIED 170X70 BLC C2F17070-A	U	207NR.3	437,67	0,67
740.0349.60	BAIGN. ENC. CALOS2 170X75+PIED BLC C2F17075-A	U	207NT.9	437,67	0,67
740.0349.60	BAIGN. A ENC. CALOS 2 180X80 BLC C2F18080-A	U	207NU.6	437,67	0,67
740.0349.60	BAIGN. ENC CALOS 2 170X80+PIED BLC C2F17080-A	U	207NV.4	437,67	0,67
740.0349.60	BAIGN. A ENC. CALOS 2 150X70 BLC C2F15070-A	U	215XZ.6	437,67	0,67

BAIGNOIRE ACIER

Roca

CONTESA

Baignoire en acier émaillée - Percée 1 trou - sans pied - Fond Lisse



	DÉSIGNATION	UT	CODE	PPHT (€)	ECOPART (€)
713.0156.00	BAIGN.AC.CONTESA 140X70 1T.BL ROCA A2361K6000	U	253WD.0	195,67	0,67
713.0195.00	BAIGN.AC.CONTESA 150X70 1T35 BLC A2360K6000	U	253WA.6	195,67	0,67
713.0156.00	BAIGN.AC.CONTESA 160X70 1T.BL ROCA A2359K6000	U	253W8.1	195,67	0,67
713.0156.00	BAIGN.AC.CONTESA 170X70 1T35 BLC A2358K6000	U	253W6.5	195,67	0,67

Roca

CONTESA

Baignoire en acier émaillée - Non percée - sans pied - Fond lisse



	DÉSIGNATION	UT	CODE	PPHT (€)	ECOPART (€)
713.0156.00	BAIGN.AC.CONTESA 140X70 NP.BL ROCA A2361K0000	U	8567V.5	195,67	0,67
713.0156.00	BAIGN.AC.CONTESA 150X70 NP.BL ROCA A2360K0000	U	8567U.7	195,67	0,67
713.0156.00	BAIGN.AC.CONTESA 160X70 NP.BL ROCA A2359K0000	U	8567T.0	195,67	0,67
713.0156.00	BAIGN.AC.CONTESA 170X70 NP.BL ROCA A2358K0000	U	7755X.5	195,67	0,67

Sanitaire
Cuisine

BAIGNOIRE

BAIGNOIRE ACIER

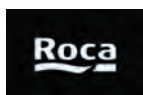

CONTESA

Accessoires - Jeux de pieds à visser



	DÉSIGNATION	UT	CODE	PPHT (€)	ECOPART (€)
713.0029.20	JEU DE PIEDS CONTESA A VISSER A291028000	U	17904.9	36,52	0,02



INSONORISATION

Plaque



	DÉSIGNATION	UT	CODE	PPHT (€)	ECOPART (€)
757.0004.52	PLAQUE INSONORISATION BAIGN.NUE ISO 0412024	U	11801.8	6,04	0,02

TABLIER DE BAIGNOIRE



HABILLAGES DE BAIGNOIRES



	DÉSIGNATION	UT	CODE	PPHT (€)	ECOPART (€)
705.0040.46	HABILLAGE DE BAIGN. 140X54 BLC 200393	U	5382B.3	51,02	0,45
705.0040.46	HABILLAGE DE BAIGN. 150X54 BLC 200394	U	5385B.0	51,05	0,48
705.0040.46	HABILLAGE DE BAIGN. 160X54 BLC 200395	U	5388B.7	51,08	0,51
705.0040.46	HABILLAGE DE BAIGN. 170X54 BLC 200396	U	5391B.2	51,12	0,55



HABILLAGES DE BAIGNOIRES

Retour



	DÉSIGNATION	UT	CODE	PPHT (€)	ECOPART (€)
705.0023.59	RETOUR DE BAIGN. 700X540 BLC 200397	U	5394B.9	29,71	0,22

PARE BAIGNOIRE

Metropolitan



EXCLUSIVITES RICHARDSON PAR ROTH FRANCE

Pare-baignoire pivotant réversible pour montage à droite ou à gauche de la baignoire - Hauteur : 150 cm - Ep. verre : 6 mm - Verre clair



	DÉSIGNATION	UT	CODE	PPHT (€)	ECOPART (€)
748.0192.66	PAROI BAIGN. METRO.2024 80X150 1406001548	U	A0724.5	240,95	0,12

BAIGNOIRE

ROBINETTERIE BAIN / DOUCHE

Metropolitan



EXCLUSIVITES RICHARDSON PAR NOBILI

Ensemble douchette



	DÉSIGNATION	UT	CODE	PPHT (€)	ECOPART (€)
748.0079.33	SET DE BAIN CPT.METRO 2 CHR ADUPL00146/5	U	2870N.4	99,17	0,01

Metropolitan



EXCLUSIVITES RICHARDSON PAR NOBILI

Mitigeur bain-douche thermostatique



	DÉSIGNATION	UT	CODE	PPHT (€)	ECOPART (€)
748.0172.00	MITIGEUR BD TH.METRO 2.CHR ME87010/1CR	U	2870R.8	215,01	0,01

Metropolitan



EXCLUSIVITES RICHARDSON PAR NOBILI

Mitigeur bain-douche mural



	DÉSIGNATION	UT	CODE	PPHT (€)	ECOPART (€)
748.0099.33	MITIGEUR BD METRO 2.CHR ME112110/1CR	U	2870P.2	124,17	0,01

Metropolitan



EXCLUSIVITES RICHARDSON PAR NOBILI

Mitigeur bain-douche monotour



	DÉSIGNATION	UT	CODE	PPHT (€)	ECOPART (€)
748.0104.00	MITIGEUR BD MONO METRO 2.CHR ME112118/10CR	U	2870Q.0	130,01	0,01

UPcity



EXCLUSIVITES RICHARDSON PAR NOBILI

Mitigeur bain/douche thermostatique mural



	DÉSIGNATION	UT	CODE	PPHT (€)	ECOPART (€)
593.0201.87	MITIGEUR B/D THERM.UPCITY CHR UCPI103010/1CR	U	200NH.5	269,17	0,01
593.0326.25	MITIGEUR B/D THERM.UPCITY NOIR UCPI103010/1BM	U	200NJ.2	435,01	0,01

Le PPHT comprend l'ecopart (€)

BAIGNOIRE

ROBINETTERIE BAIN / DOUCHE



EXCLUSIVITES RICHARDSON PAR NOBILI

Mitigeur bain/douche mural



	DÉSIGNATION	UT	CODE	PPHT (€)	ECOPART (€)
593.0186.87	MITIGEUR B/D UPCITY NOIR UPCI87110/1BM	U	200NL.8	249,17	0,01



EXCLUSIVITES RICHARDSON PAR PAINI FRANCE

Mitigeur BD monotrou



	DÉSIGNATION	UT	CODE	PPHT (€)	ECOPART (€)
592.0052.16	MITIGEUR B/D MONOTROU EAZY EZCR106	U	3772L.1	65,21	0,01



EXCLUSIVITES RICHARDSON PAR PAINI FRANCE

Mitigeur B/D mural



	DÉSIGNATION	UT	CODE	PPHT (€)	ECOPART (€)
592.0060.88	MITIGEUR B/D MURAL EAZY EZCR111	U	3772F.7	76,11	0,01
592.0132.40	MITIGEUR B/D MURAL/THERM. C3 EAZY EZCR111TH	U	277W7.2	165,51	0,01



EXCLUSIVITES RICHARDSON PAR PAINI FRANCE

Set de bain complet



	DÉSIGNATION	UT	CODE	PPHT (€)	ECOPART (€)
592.0030.48	SET DE BAIN CPLT EAZY EZ526	U	3771S.5	38,11	0,01



BAUEDGE

Mitigeur bain-douche mural



	DÉSIGNATION	UT	CODE	PPHT (€)	ECOPART (€)
762.0081.34	MITIGEUR B/D MUR. BAUEDGE CHR GROHE 23561000	U	6129U.2	90,40	0,02
762.0064.77	MITIGEUR DCH.MUR.BAUEDGE CHR GROHE 23560000	U	6129W.8	71,99	0,02
762.0120.45	MITIGEUR B/D BAUEDGE MONO. CHR GROHE 23562000	U	6129Y.4	133,85	0,02

Le PPHT comprend l'ecopart (€)

BAIGNOIRE

ROBINETTERIE BAIN / DOUCHE



BAULOOP

Mitigeur bain-douche mural



	DÉSIGNATION	UT	CODE	PPHT (€)	ECOPART (€)
762.0102.14	MITIGEUR B/D MUR.BAULOOP CHR GROHE 23602001	U	287VE.6	113,51	0,02



EUROSMART

Mitigeur bain-douche monocommande



	DÉSIGNATION	UT	CODE	PPHT (€)	ECOPART (€)
762.0123.24	MITIGEUR B/D EUROSMART OHM CHR 32158003	U	323K9.6	123,26	0,02
762.0132.10	MITIGEUR B/D EUROSMART OHM MON/T CHR 33412003	U	323KD.7	132,12	0,02



EUROSMART NEW

Mitigeur bain-douche sur plage



	DÉSIGNATION	UT	CODE	PPHT (€)
762.0118.80	MITIGEUR B/D EUROSMART2015 GROHE 33412002	U	6161T.4	132,00



EUROSMART COSMOPOLITAN

Mitigeur bain-douche mural



	DÉSIGNATION	UT	CODE	PPHT (€)	ECOPART (€)
762.0121.02	MITIGEUR B/D EUROSMART COSMO. GROHE 32833000	U	4853G.5	134,49	0,02



GROHTHERM 800

Mitigeur bain-douche thermostatique



	DÉSIGNATION	UT	CODE	PPHT (€)	ECOPART (€)
762.0206.59	MITIGEUR B/D THERM. GRT800 GROHE 34569000	U	5656P.6	229,57	0,02

BAIGNOIRE

ROBINETTERIE BAIN / DOUCHE



GROHTHERM 1000

C3 - Mitigeur bain-douche thermostatique mural



DÉSIGNATION	UT	CODE	PPHT (€)	ECOPART (€)
762.0296.64 MITIGEUR TH B/D GROHTHERM 1000 NEW 34821003	U	299E3.7	296,66	0,02

hansgrohe

LOGIS

Mitigeur bain-douche monotrou



DÉSIGNATION	UT	CODE	PPHT (€)	ECOPART (€)
765.0130.38 MITIGEUR B/D MONOTROU LOGIS H.GROHE 71315000	U	4801X.6	144,89	0,02

hansgrohe

TICA

Exclusivité RICHARDSON - Mitigeur bain-douche



DÉSIGNATION	UT	CODE	PPHT (€)	ECOPART (€)
765.0120.66 MITIGEUR BAIN/DCH MURAL TICA CHR 14419000	U	319K5.2	150,84	0,01

hansgrohe

TICA

Exclusivité RICHARDSON - Mitigeur thermostatique bain-douche



DÉSIGNATION	UT	CODE	PPHT (€)	ECOPART (€)
765.0210.60 MITIGEUR THERM. BAIN/DCH TICA CHR 13253000	U	319K7.8	263,26	0,01

hansgrohe

VERNIS BLEND

Mitigeur bain douche mural avec cartouche à 2 vitesses



DÉSIGNATION	UT	CODE	PPHT (€)	ECOPART (€)
765.0083.53 MITIGEUR DCH.VERN/BLEND CHR H.GROHE 71646000	U	331VE.2	92,83	0,02
765.0164.11 MITIGEUR B/D VERNIS BLEND NOIR/MAT 71440670	U	344SZ.9	164,13	0,02
765.0104.92 MITIGEUR B/D MUR.VERNISBLEND H.GROHE 71454000	U	350E7.9	116,60	0,02

hansgrohe

VERNIS BLEND

Mitigeur bain/ douche monotrou avec cartouche à 2 vitesses



DÉSIGNATION	UT	CODE	PPHT (€)	ECOPART (€)
765.0146.68 MITIGEUR B/D MONO CHR VERNIS H.GROHE 71446000	U	350B1.5	163,00	0,02

BAIGNOIRE

ROBINETTERIE BAIN / DOUCHE

hansgrohe

VERNIS BLEND

Set de finition pour mitigeur bain/ douche encastré



DÉSIGNATION	UT	CODE	PPHT (€)	ECOPART (€)
765.0104.92 FACADE B/D ENC.VERNIS BLEND CHR 71466000	U	350BA.5	116,60	0,02



ALEO

Mitigeur bain/douche mural



DÉSIGNATION	UT	CODE	PPHT (€)	ECOPART (€)
767.0157.00 MITIGEUR B/D MURAL ALEO CHR JD E72282-CP	U	2894U.4	196,27	0,02



BRIVE

Mitigeur bain-douche monotrou



DÉSIGNATION	UT	CODE	PPHT (€)	ECOPART (€)
767.0109.24 MITIGEUR B/D BRIVE MONOT. S/G CHR E75769-4-CP	U	224VK.8	136,57	0,02



BRIVE

Mitigeur bain-douche mural



DÉSIGNATION	UT	CODE	PPHT (€)	ECOPART (€)
767.0111.28 MITIGEUR B/D MUR.BRIVE AV.CONN. JD E75766-CP	U	8002D.3	139,12	0,02



BRIVE

Mitigeur bain-douche mural - Mitigeur thermostatique bain-douche mural



DÉSIGNATION	UT	CODE	PPHT (€)	ECOPART (€)
767.0193.48 MITIGEUR BD/MURAL THERM BRIVE CHR E24335-CP	U	266AA.4	241,87	0,02



JULY

Mitigeur



DÉSIGNATION	UT	CODE	PPHT (€)	ECOPART (€)
767.0114.80 MITIGEUR B/D MURAL JULY CHR JD E16033-4-CP	U	3266F.0	143,52	0,02

Le PPHT comprend l'ecopart (€)

BAIGNOIRE

ROBINETTERIE BAIN / DOUCHE

Jacob Delafon
PARIS

JULY
Mitigeur



	DÉSIGNATION	UT	CODE	PPHT (€)	ECOPART (€)
767.0113.88	MITIGEUR B/D MONOTROU JULY JD E16044-4-CP	U	3266D.5	142,37	0,02

Jacob Delafon
PARIS

JULY
Mitigeur bain-douche
thermostatique mural - Avec blocage
température maxi à 50°C



	DÉSIGNATION	UT	CODE	PPHT (€)	ECOPART (€)
767.0214.80	MITIGEUR B/D THERM. JULY CHR JD E45714-CP	U	9657J.7	268,52	0,02

Roca

NIAGARA

Mélangeur bain-douche mural - Avec inverseur
automatique



	DÉSIGNATION	UT	CODE	PPHT (€)	ECOPART (€)
769.0076.48	MELANGEUR B/D MUR. NIAGARA+N ZOOM A5A0269C00	U	3563J.4	95,62	0,02

Roca

NIAGARA

Mélangeur bain-douche monotrou sur le
bord de la baignoire



	DÉSIGNATION	UT	CODE	PPHT (€)	ECOPART (€)
769.0079.76	MELANGEUR B/D MONO NIAGARA+N ZOOM A5AD569C00	U	3563J.3	99,72	0,02

VIDAGE/SIPHON DE BAIGNOIRE

TEKNIK



EXCLUSIVITES RICHARDSON PAR CGS

Vidage baignoire



	DÉSIGNATION	UT	CODE	PPHT (€)	ECOPART (€)
000.0080.40	VIDAGE P/BAIGN. TEKNIK LAIT/CHR TK106-PLUS.01	U	275DA.2	80,41	0,01
000.0100.40	VIDAGE P/BAIGN. TEKNIK NOIR/MAT TK106-PLUS.43	U	275DC.8	100,41	0,01

BAIGNOIRE

VIDAGE/SIPHON DE BAIGNOIRE

GEBERIT
UNIFLEX

Vidage automatique avec set de finition - Pour
baignoire standard ø 52 mm



	DÉSIGNATION	UT	CODE	PPHT (€)	ECOPART (€)
716.0111.43	VIDAGE BAIGN. ACT. ROT. D52 L23 CHR 150.616.21.6	U	345EN.6	111,45	0,02

hansgrohe

FLEXAPLUS

E - Vidage complet pour baignoire standard - Avec
trop plein souple



	DÉSIGNATION	UT	CODE	PPHT (€)	ECOPART (€)
765.0076.55	VIDAGE BAIGN. FLEXAPLUS E H.GROHE 58142000	U	77362.2	85,07	0,02

Nicoll
by allaxis

EASYBAIN WAVE

Vidage à câble avec siphon à joint intégré, volant design et
clapet recouvrant ABS - Plastique



	DÉSIGNATION	UT	CODE	PPHT (€)	ECOPART (€)
757.0054.22	VIDAGE BAIGN. EB07 EASYBAIN WAVE 65CM 0203611	U	4309G.5	72,31	0,02
757.0067.61	VIDAGE BAIGN. EB17 EASYBAIN WAVE 1M 0203612	U	4317C.4	90,17	0,02

Nicoll
by allaxis

SIPHON

Plastique - Articulé



	DÉSIGNATION	UT	CODE	PPHT (€)	ECOPART (€)
757.0009.76	SIPHON BAIGN. SORT. HORIZ. 360DEGRES 207 0203250	U	67831.8	13,03	0,02

Nicoll
by allaxis

TURBOBAIN

Vidage à câble - Plastique - Clapet inox recouvrant ø 70
mm



	DÉSIGNATION	UT	CODE	PPHT (€)	ECOPART (€)
757.0037.10	VIDAGE BAIGN. TURBOBAIN CABLE65 TBR07 0203577	U	06441.3	49,49	0,02

Nicoll
by allaxis

VIDAGE

A chaînette - Plastique - Câble 650 mm - Trop-plein avec
positionneur



	DÉSIGNATION	UT	CODE	PPHT (€)	ECOPART (€)
757.0016.57	VIDAGE BAIGN. A CHAINETTE+SIPHON B202 0203002	U	38397.6	22,11	0,02

Le PPHT comprend l'ecopart (€)

BAIGNOIRE

ACCESSOIRES DE BAIGNOIRE

Jacob Delafon
PARIS

GOMME A DERAYER L'EMAIL



	DÉSIGNATION	UT	CODE	PPHT (€)
704.0031.48	GOMME A DERAYER EMAIL JD E3231-NF	U	32113.3	39,35

Pour plus d'infos,
consultez
le CAHIER TECHNIQUE
page 14

ACCESSOIRES DE SALLE DE BAINS

GAMME CONFORT

PELLET

LOFT

Porte-serviettes



	DÉSIGNATION	UT	CODE	PPHT (€)	ECOPART (€)
756.0033.32	PORTE-SERV.FIXE 1B 40 PELLET 010140	U	5064C.6	41,66	0,01

PELLET

SERIE 39

Barre de relèvement - ø 25 mm -
Entraxe 30 cm



	DÉSIGNATION	UT	CODE	PPHT (€)	ECOPART (€)
756.0035.60	BARRE D'APPUI INOX 400 000104	U	262MP.3	44,51	0,01

PELLET

PORTE RIDEAU

Droit extensible - Tube ø 16 x 0,5 mm
- Fixation par opposition



	DÉSIGNATION	UT	CODE	PPHT (€)	ECOPART (€)
756.0078.64	PORTE RIDEAU DROIT EXT.102-180 PELLET 004912	U	25140.5	98,31	0,01

PELLET

RIDEAU DE DOUCHE

PVC blanc - anneaux plastique -
Ourlet plombé



	DÉSIGNATION	UT	CODE	PPHT (€)
756.0016.48	RIDEAU DE DOUCHE 180X90 BLANC PELLET 804090	U	25803.8	20,60

PELLET

RIDEAU DE DOUCHE

PVC blanc - anneaux plastique - Bas
coupé



	DÉSIGNATION	UT	CODE	PPHT (€)
756.0030.68	RIDEAU DE DOUCHE 200X180 BLANC PELLET 804182	U	31614.1	38,35

Le PPHT comprend l'ecopart (€)

ACCESSOIRES DE SALLE DE BAINS

GAMME ECONOMIQUE



SERIE ECONOMIQUE

Barre d'appui - Droite



	DÉSIGNATION	UT	CODE	PPHT (€)	ECOPART(€)
756.0022.40	BARRE APPUI HYPECO CHR. 30 PELLET 822964	U	14343.8	28,01	0,01
756.0054.88	BARRE APPUI COUD.135 20X20 BLC PELLET 049832	U	6603S.2	68,61	0,01
756.0067.32	BARRE APPUI COUDEE 135 BLANC/CHR.SAT. 049932	U	66987.9	84,16	0,01
756.0031.40	BARRE APPUI DRTE 30CM TUBE INOX POL/BR 000103	U	271FV.8	39,26	0,01
756.0039.00	BARRE APPUI ECO DRTE 60CM POLI/BRI 000106	U	281PH.9	48,76	0,01



SERIE ECONOMIQUE

Barre d'appui - Coudée 135°



	DÉSIGNATION	UT	CODE	PPHT (€)	ECOPART(€)
756.0058.00	BARRE APPUI COUDEE 135 3PF CHR 000135	U	267LT.5	72,51	0,01

Pour plus d'infos,
consultez
le CAHIER TECHNIQUE
page 14

100% EXPO



Faites de nos salles Expo vos outils de vente

- Des espaces dédiés à la Salle de Bains et au Carrelage
- Les dernières tendances
- Des conseillers pour accompagner vos clients dans leur projet

Sanitaire
Cuisine

Le PPHT comprend l'ecopart (€)

Les tarifs et disponibilités de nos produits peuvent évoluer sans préavis

RICHARDSON

| 235 |

100% Exclusivités WC

eaZY
par Vitra



Pro

Metropolitan
par GEBERIT



Essentiel

UPcity
par DURAVIT



Tendance

Sign
par Vitra



Design

Les gammes exclusives,
Le meilleur atout des Pros

- Des prix publics attractifs
- La qualité des grandes marques
- Produits et pièces détachées disponibles rapidement

Retrouvez tous les produits
exclusifs dans nos catalogues !



RICHARDSON

WC

BATI SUPPORT WC

TEKNIK
Collections Exclusives

EXCLUSIVITES RICHARDSON PAR TECE
Bâti-support - NF - Bâti support + plaque blanche



	DÉSIGNATION	UT	CODE	PPHT (€)	ECOPART (€)
000.0276.67	BATI-SUPPORT+PLAQUE BLANC TEKNIK NEW 9500311	U	368KU.9	276,68	0,01

TEKNIK
Collections Exclusives

EXCLUSIVITES RICHARDSON PAR TECE
Bâti-support - NF - Bâti support + plaque chromée



	DÉSIGNATION	UT	CODE	PPHT (€)	ECOPART (€)
000.0313.33	BATI-SUPPORT+PLAQUE CHROME TEKNIK NEW 9500312	U	368KV.7	313,34	0,01

GEBERIT
DUOFIX

Bâti-support Delta



	DÉSIGNATION	UT	CODE	PPHT (€)	ECOPART (€)
702.0340.23	BATI-SUP.AUTOP.DUOFIX DELTA 112CM 457565002	U	264ZY.1	425,30	0,01

GEBERIT
DUOFIX

Bâti-support Sigma



	DÉSIGNATION	UT	CODE	PPHT (€)	ECOPART (€)
716.0433.02	BATI-SUP. WC AUTOP.DUOFIX SIGMA 111.333.00.5	U	18526.4	541,43	0,15
716.0349.81	BATI-SUP.APPL.DUOFIX SIGMA GEBERIT 111303005	U	1887E.5	437,41	0,15

GEBERIT
SIGMA

01 - Plaque de déclenchement double
touche - Compatible avec tous bati

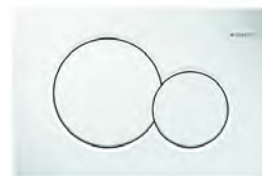

	DÉSIGNATION	UT	CODE	PPHT (€)	ECOPART (€)
716.0062.47	PLAQUE DECL.SIGMA01 BLC GEBERIT 115770115	U	9198H.6	78,11	0,02
716.0082.16	PLAQUE DECL.SIGMA01 CHR/BR GEBERIT 115770215	U	24891.4	102,72	0,02

GEBERIT
SIGMA

01 - Plaque de déclenchement double
touche - Double touches



	DÉSIGNATION	UT	CODE	PPHT (€)	ECOPART (€)
716.0082.16	PLAQUE DECL.SIGMA01 2/TO CHR/MAT 115.770.JQ.5	U	301SA.7	102,72	0,02

Le PPHT comprend l'ecopart (€)

WC

BATI SUPPORT WC

GEBERIT
SIGMA

30 - Plaque de déclenchement



	DÉSIGNATION	UT	CODE	PPHT (€)	ECOPART (€)
716.0103.11	PLAQUE DECL. SIGMA30 BLC/C.BR 115.883.KJ.1	U	8382S.5	128,91	0,02

GEBERIT
SIGMA20 - Plaque de déclenchement double touche
- En matière synthétique - Compatible avec réservoirs UP320 et UP720

	DÉSIGNATION	UT	CODE	PPHT (€)	ECOPART (€)
716.0119.87	PLAQUE DECL. SIGMA20 CHR/BR 115.882.KH.1	U	8394N.9	149,86	0,02
716.0188.14	PLAQUE DECL. SIGMA20 METAL BR/POLI 115.889SN1	U	0132J.1	235,20	0,02
716.0121.06	PLAQUE DECL. SIGMA 20 CHR/MAT 115.882.JO.1	U	272MQ.0	151,35	0,02

GEBERIT
SIGMA

20 - Plaque de déclenchement double touche - Duo Chromé



	DÉSIGNATION	UT	CODE	PPHT (€)	ECOPART (€)
716.0090.95	PLAQUE DECL. SIGMA20 BLC/CHR BR. 115.882.KJ.1	U	8394Q.5	113,71	0,02

GEBERIT
ACCESSOIRES BATI-SUPPORT

Cache-boulons pour bâti-support - Jeu de 2



	DÉSIGNATION	UT	CODE	PPHT (€)	ECOPART (€)
716.0006.62	CACHE-BOULONS BLANC - JEU- GEBERIT 217713111	U	7340G.9	8,29	0,01

GEBERIT
ACCESSOIRES BATI-SUPPORT

Jeu de fixations murales Duofix - Profondeur d'ajustement 13-20 cm

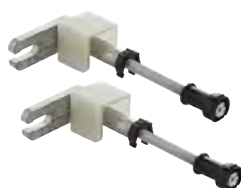

	DÉSIGNATION	UT	CODE	PPHT (€)	ECOPART (€)
716.0041.57	JEU FIX. MURAL DUOFIX GEBERIT 111815001	U	2972C.4	51,97	0,01

GEBERIT
HABILLAGE POUR BATI-SUPPORT WC

Support d'habillage pour bâti-support



	DÉSIGNATION	UT	CODE	PPHT (€)	ECOPART (€)
716.0105.08	SUPPORT D HABILLAGE POUR MUR 111.217.00.1	U	302SP.7	131,36	0,01

Le PPHT comprend l'ecopart (€)

WC

BATI SUPPORT WC

GEBERIT
PLAQUE DE DECLenchement

	DÉSIGNATION	UT	CODE	PPHT (€)	ECOPART (€)
716.0069.03	PLAQUE DECL. PNEUM. TYPE01 BLC/ALP 116046111	U	190VU.2	86,31	0,02

GEBERIT
PLAQUE DE DECLenchement

Delta Zero



	DÉSIGNATION	UT	CODE	PPHT (€)	ECOPART (€)
702.0067.39	PLAQUE DECL./DBL DELTAZERO CHR/BR 115.100.21.5	U	355BZ.6	84,25	0,01
716.0067.39	PLAQUE DECL./DBL DELTA ZERO CHR/M 115.100.46.5	U	36803.4	84,25	0,01
716.0055.46	PLAQUE DECL. DELTA ZERO BLC/ALP. 115.100.11.5	U	367BC.5	69,33	0,01

**RAPID SL**
Bâti-support

	DÉSIGNATION	UT	CODE	PPHT (€)	ECOPART (€)
762.0240.35	BATI-SUP.AUT. RAPID SL 1,13M GROHE 38340001	U	41731.1	267,20	0,15
762.0200.83	BATI-SUP. RAPID SL SET WC GROHE 39145000	U	8203F.5	223,29	0,15

**SKATE AIR**
Plaque de commande pneumatique

	DÉSIGNATION	UT	CODE	PPHT (€)	ECOPART (€)
762.0047.15	PLAQUE CDE VERT. SKATE AIR CHR GROHE 38505000	U	39830.5	52,41	0,02
762.0037.63	PLAQUE CDE VERT. SKATE AIR BLC GROHE 38505SHO	U	34961.3	41,83	0,02

**SKATE COSMOPOLITAN**
Plaque de commande pour mécanisme pneumatique - Double touche ou interrompable pour mécanisme pneumatique

	DÉSIGNATION	UT	CODE	PPHT (€)	ECOPART (€)
762.0057.64	PLAQUE CDE SKATE COSMO.HZ GROHE 38732000	U	13881.1	64,06	0,02
762.0049.63	PLAQUE CDE.SKATE COSMO BLC GROHE 38732SHO	U	3634J.8	55,17	0,02

WC

BATI SUPPORT WC



INGENIO

Bati support autoportant



	DÉSIGNATION	UT	CODE	PPHT (€)	ECOPART (€)
759.0287.71	BATI-SUP.AUTO.EVAC.COUDEE INGENIO 31310110	U	27497.7	359,79	0,15



YIN YANG

Plaque de commande



	DÉSIGNATION	UT	CODE	PPHT (€)	ECOPART (€)
759.0031.82	PLAQUE COMM.DV YINYANG BLC SIAMP 31180010	U	70764.6	39,80	0,02



ACCESSOIRES POUR BATI-SUPPORTS

Kit liaison cuvette



	DÉSIGNATION	UT	CODE	PPHT (€)	ECOPART (€)
526.0016.54	KIT LIAISON CUV. STAND BAT-INGENIO 34117167	U	2761Y.6	20,70	0,02



ACCESSOIRES POUR BATI-SUPPORTS

Plaque commande



	DÉSIGNATION	UT	CODE	PPHT (€)	ECOPART (€)
759.0043.31	PLAQUE COM. SPHERE-INGENIO BLC 31261060	U	2750T.0	54,16	0,02
759.0068.35	PLAQUE COM. SPHERE-INGENIO CHR MAT 31261160	U	2750V.5	85,46	0,02
759.0073.06	PLAQUE COM. SPHERE-INGENIO CHR BRIL. 31261260	U	2750W.3	91,34	0,02

100% Exclusivités

TEKNIK

par **TECE:**

Intelligente Haustechnik



BÂTI-SUPPORT



- Prêt à poser avec fixations murales et plaque
- Réglages faciles (chasse et plaque)
- Isolation phonique
- Pieds réglables individuellement
- Mécanisme pré-monté
- Adaptateur PVC pour évacuation sortie droite coudée

Compatible avec toutes les plaques TECE +



Uniquement chez **RICHARDSON**

Le PPHT comprend l'ecopart (€)

WC

PACK WC SUSPENDU



EXCLUSIVITES RICHARDSON PAR VITRA

Pack WC suspendu



DÉSIGNATION	UT	CODE	PPHT (€)	ECOPART (€)
592.0082.48 PACK WC SUSP.AB.STD C.MET 6107B003-6150 EAZY	U	164BD.4	103,17	0,07



EXCLUSIVITES RICHARDSON PAR GEBERIT

Pack WC suspendu - Pack WC suspendu Rimfree®



DÉSIGNATION	UT	CODE	PPHT (€)	ECOPART (€)
748.0210.66 PACK WC SUSP.RIMFREE METROPOL. 08399800000500	U	201DZ.0	263,40	0,07



EXCLUSIVITES RICHARDSON PAR GEBERIT

Pack WC suspendu - Pack WC suspendu avec bride



DÉSIGNATION	UT	CODE	PPHT (€)	ECOPART (€)
748.0154.00 PACK WC SUSP. METROPOLITAN 08399900000500	U	201E0.9	192,57	0,07



EXCLUSIVITES RICHARDSON PAR VITRA

Pack WC suspendu



DÉSIGNATION	UT	CODE	PPHT (€)	ECOPART (€)
593.0289.33 PACK WC SUSP.SIGN ABFR CH/M BLC 7041B003-6184	U	199XC.6	361,73	0,07



D-NEO

Pack WC suspendu Rimless®



DÉSIGNATION	UT	CODE	PPHT (€)	ECOPART (€)
709.0494.00 PACK WC SUSP. D-NEO RIMLESS 540 45770900A1	U	319DJ.0	494,07	0,07

WC

PACK WC SUSPENDU



ME BY STARCK 570

Pack wc suspendu



DÉSIGNATION	UT	CODE	PPHT (€)	ECOPART (€)
708.0848.00 PACK WC SUSP.ME BY STARK RIMLESS 45290900A1	U	7479N.9	848,07	0,07



PACK WC ODEON

Cuvette suspendue longue rallongée



DÉSIGNATION	UT	CODE	PPHT (€)	ECOPART (€)
704.0291.24 CUVETTE WC SUSP.LG ODEON BLC JD E1195-00	U	9011C.2	364,17	0,12



PACK STRUKTURA

WC suspendu sans bride



DÉSIGNATION	UT	CODE	PPHT (€)	ECOPART (€)
704.0260.84 PACK WC STRUKTURA JD EDE122-00	U	8686L.0	326,26	0,21

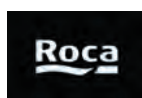

THE GAP RIMLESS

Ensemble WC suspendu The Gap Rimless



DÉSIGNATION	UT	CODE	PPHT (€)	ECOPART (€)
713.0406.00 PACK WC SUSP. RIMLESS THE GAP BLC A34H47L000	U	6733S.5	406,21	0,21



NORMUS

Pack WC suspendu



DÉSIGNATION	UT	CODE	PPHT (€)	ECOPART (€)
522.0140.80 PACK CUV. SUSP.NORMUS SPINFUSH 7855B003-6150	U	251MZ.6	176,21	0,21

Le PPHT comprend l'ecopart (€)

WC

WC SUSPENDU

DURAVIT

CUVETTE STARCK 3

Cuvette suspendue à fond creux - Avec système Durafix : fixations dissimulées



	DÉSIGNATION	UT	CODE	PPHT (€)	ECOPART (€)
708.0340.80	CUVETTE SUSP.STARCK3 36X54 BLC 2225090000	U	5195K.2	426,04	0,04

GEBERIT
BASTIA

Cuvette suspendue - A fond creux



	DÉSIGNATION	UT	CODE	PPHT (€)	ECOPART (€)
716.0075.06	CUVETTE SUSP. BASTIA FOND CREUX 501.769.00.1	U	295SM.7	93,94	0,12

Jacob Delafon

MIDEO

Cuvette suspendue semi-carénée à siphon lisse



	DÉSIGNATION	UT	CODE	PPHT (€)	ECOPART (€)
704.0081.48	CUVETTE SUSP.MIDEO BLC JD E4345-00	U	32528.2	101,97	0,12
704.0089.72	CUVETTE SUSP. MIDEO 52X36 BLC E4345-Y1-00	U	0313F.9	112,27	0,12

Jacob Delafon

PATIO

Cuvette suspendue



	DÉSIGNATION	UT	CODE	PPHT (€)	ECOPART (€)
704.0125.76	CUVETTE PATIO SUSP. SS/BRIDE BLC EDV101-00	U	171HB.7	157,32	0,12

Jacob Delafon

STRUKTURA

Cuvette suspendue compacte sans bride



	DÉSIGNATION	UT	CODE	PPHT (€)	ECOPART (€)
700.0211.12	CUVETTE SUSP.COMPACTE STRUKTURA BLC EDF101-00	U	217EW.0	264,02	0,12

Jacob Delafon

VOX

WC suspendu - Cuvette suspendu sans bride carénée



	DÉSIGNATION	UT	CODE	PPHT (€)	ECOPART (€)
704.0365.68	PACK WC SUSP. VOX EXTRA/PL.3/6L JD EDM112-00	U	170N3.1	457,31	0,21

WC

WC SUSPENDU

Vitra

CONFORMA-VITRA FLUSH - PMR

Cuvette



	DÉSIGNATION	UT	CODE	PPHT (€)	ECOPART (€)
000.0197.60	CUVETTE SUSP.CONFORMA 70 PMR 5813B003-0075	U	8115V.2	247,12	0,12
000.0205.60	CUVETTE SUSP.CONFORMA 70 SS.TR. 5813B003-0979	U	81161.2	257,12	0,12

Vitra

NORMUS

WC suspendu



	DÉSIGNATION	UT	CODE	PPHT (€)	ECOPART (€)
000.0101.60	CUVETTE SUSP.NORMUS 36X54CM 6855L003-1026	U	2461E.7	127,21	0,21

PACK WC SUR PIED

eazy Collections Exclusives

EXCLUSIVITES RICHARDSON PAR VITRA

Pack WC sur pied



	DÉSIGNATION	UT	CODE	PPHT (€)	ECOPART (€)
592.0138.32	PACK WC SOL SH A.LAT.ABFR 9865B003-7208 EAZY	U	391VV.4	172,97	0,07
592.0146.30	PACK WC SOL SH. AL.LAT. EAZY 9865B003-7206	U	391VT.9	146,37	0,07

Metropolitan Collections Exclusives

EXCLUSIVITES RICHARDSON PAR GEBERIT

Pack WC sur pied - Pack WC sur pied avec bride



	DÉSIGNATION	UT	CODE	PPHT (€)	ECOPART (€)
748.0179.33	PACK WC SOL SH METROPOLITAN 08320700000500	U	201DT.2	224,23	0,07

Metropolitan Collections Exclusives

EXCLUSIVITES RICHARDSON PAR GEBERIT

Pack WC sur pied - Pack WC sur pied Rimfree®



	DÉSIGNATION	UT	CODE	PPHT (€)	ECOPART (€)
748.0248.00	PACK WC SOL SH RIMFREE METRO 08320800000500	U	201DX.3	310,07	0,07

Le PPHT comprend l'ecopart (€)

WC

PACK WC SUR PIED



EXCLUSIVITES RICHARDSON PAR VITRA
Pack WC sur pied



	DÉSIGNATION	UT	CODE	PPHT (€)	ECOPART (€)
593.0356.00	PACK WC SOL SH.ABFR C.MET. SIGN 98308003-7206	U	199XT.4	445,07	0,07



EXCLUSIVITES RICHARDSON PAR DURAVIT
Pack WC sur pied



	DÉSIGNATION	UT	CODE	PPHT (€)	ECOPART (€)
593.0274.94	PACK WC S/PIED CUV.SH RIM+ABAT.FR/CHUT UPCITY	U	199N8.9	366,65	0,07

GEBERIT
RENOVA COMFORT
Pack WC au sol, surélevé



	DÉSIGNATION	UT	CODE	PPHT (€)	ECOPART (€)
702.0371.70	PACK WC SUREL.RENOVA COMFORT RIM 501.849.01.1	U	285NV.0	464,84	0,21



EOLIA
Pack WC au sol



	DÉSIGNATION	UT	CODE	PPHT (€)	ECOPART (€)
704.0148.28	PACK WC EOLIA S.HOR./ALIM.DESS 3/6L E24448-00	U	254DD.1	185,56	0,21



ODEON UP
Pack WC sur pied - Sortie horizontale



	DÉSIGNATION	UT	CODE	PPHT (€)	ECOPART (€)
704.0366.15	PACK WC S/P ODEON UP ABAT/TH. S/H E22770-00	U	363A9.2	366,36	0,21
704.0326.45	PACK WC/SOL ODEON UP ABAT/STAND.SH E22769-00	U	363AE.0	326,66	0,21



WC COMBIPACK ODEON UP
Ensemble WC compact - Sortie horizontale



	DÉSIGNATION	UT	CODE	PPHT (€)	ECOPART (€)
527.0423.56	PACK WC ODEON UP COMPACT S.H BLC JD E0374-00	U	1098L.7	529,66	0,21

Le PPHT comprend l'ecopart (€)

WC

PACK WC SUR PIED

Vitra

NORMUS
Pack WC sur pied - Sortie horizontale



	DÉSIGNATION	UT	CODE	PPHT (€)	ECOPART (€)
000.0252.00	PACK WC S/PIED NORMUS REHAUSSE 9836B003-7204	U	208Y3.4	315,21	0,21
522.0180.00	PACK WC NORMUS S/H S/P CHAR/MET 9780B003-7208	U	251DE.4	225,00	

Vitra

ZENTRUM
Pack WC sur pied



	DÉSIGNATION	UT	CODE	PPHT (€)	ECOPART (€)
000.0334.40	PACK WC ZENTRUM BLC 9012B003-7207	U	8202D.1	418,21	0,21

WC SUR PIED

GEBERIT
BAMBINI

Cuvette au sol à fond creux



	DÉSIGNATION	UT	CODE	PPHT (€)	ECOPART (€)
702.0169.89	CUVETTE BEBE SH BAMBINI BLC 211650000	U	247G1.8	212,48	0,12
702.0158.34	CUVETTE SOL ENFANT BAMBINI BLC 500.916.00.1	U	247FZ.1	198,04	0,12

GEBERIT
PUBLICA

Cuvette à alimentation indépendante - Sortie horizontale



	DÉSIGNATION	UT	CODE	PPHT (€)	ECOPART (€)
702.0096.25	CUVETTE INDEP.PUBLICA S.H BLC 00309000000	U	3142C.7	120,43	0,12
702.0104.54	CUVETTE PUBLICA S.H. BLC 00309010000	U	2458K.1	130,79	0,12



BRIVE
Cuvette surélevée sur pied - Sortie horizontale



	DÉSIGNATION	UT	CODE	PPHT (€)	ECOPART (€)
704.0150.32	CUVETTE WC SURELEV.BRIVE S.H.BLC JD E1730-00	U	5725K.1	188,02	0,12

WC

WC SUR PIED



BRIVE

Cuvette - Sortie horizontale - Réservoir non inclus



	DÉSIGNATION	UT	CODE	PPHT (€)	ECOPART (€)
704.0078.60	CUVETTE WC BRIVE3 S.HORIZ.BLC JD E4380-00	U	91370.7	98,37	0,12



BRIVE 3

Cuvette WC - Sortie verticale



	DÉSIGNATION	UT	CODE	PPHT (€)	ECOPART (€)
704.0111.56	CUVETTE WC BRIVE3 S.VERT.BLC JD E4381-00	U	91376.4	139,57	0,12

RESERVOIR WC



BRIVE

Réservoir alimentation latérale - A économiseur d'eau 3/6 L



	DÉSIGNATION	UT	CODE	PPHT (€)	ECOPART (€)
704.0068.20	RESERVOIR BRIVE 3/6L ALIM.LAT BLC JD E4452-00	U	2619S.3	85,33	0,08

■ GEBERIT RESERVOIR DE CHASSE ATTENANT, DOUBLE TOUCHE



	DÉSIGNATION	UT	CODE	PPHT (€)	ECOPART (€)
716.0153.86	RESERVOIR APPAR.AP128 DBL/TOUCH. 128.317.11.5	U	9199P.2	192,40	0,08

■ GEBERIT RESERVOIR DE CHASSE DOUBLE TOUCHE INTERROMPABLE



	DÉSIGNATION	UT	CODE	PPHT (€)	ECOPART (€)
716.0169.25	RESERVOIR B.P.INTER.BLANC GEBERIT 140017111	U	57386.5	211,64	0,08

WC

RESERVOIR WC

■ GEBERIT ACCESSOIRES

Modérateur de débit



	DÉSIGNATION	UT	CODE	PPHT (€)	ECOPART (€)
716.0006.58	MODERATEUR DE DEBIT GEBERIT 240476001	U	8774D.9	8,25	0,02

■ GEBERIT RESERVOIR DE CHASSE, POSITION HAUTE



	DÉSIGNATION	UT	CODE	PPHT (€)	ECOPART (€)
716.0167.26	RESERVOIR 6/9L A CHAIN.BLC GEBERIT 123700111	U	48414.7	209,15	0,08
716.0172.37	RESERVOIR 6/9L DECL.PN.BLC GEBERIT 123701111	U	46933.8	215,54	0,08

■ GEBERIT ACCESSOIRES DE LIAISON POUR CUVETTE SUSPENDUE



	DÉSIGNATION	UT	CODE	PPHT (€)	ECOPART (€)
716.0028.64	MANCHETTE RACCORD.WC -JEU- GEBERIT 152404461	U	76627.9	35,81	0,01
716.0008.94	MANCHETTE ALIM.WS SUSPD 45 GEBERIT 152434161	U	41561.2	11,19	0,01
702.0015.73	MANCHON RAC.PE90 PVC93-6/100GEBERIT 359144111	U	69448.9	19,68	0,02
716.0069.50	MANCHETTE RACCORD.WC -JEU- GEBERIT 152403161	U	28209.5	86,89	0,02

■ REGIPLAST

DUETTO

Réservoir universel - Installation attenante ou semi-basse



	DÉSIGNATION	UT	CODE	PPHT (€)
754.0095.22	RESERVOIR ATTEN.DUETTO DBL.T. REGIPLAST 4150	U	7007F.5	119,03

■ REGIPLAST

RESERVOIR DE CHASSE ATTENANT UNIVERSEL REGIPLAST

Réservoir double débit - Registrar



	DÉSIGNATION	UT	CODE	PPHT (€)
754.0104.62	RESERVOIR ATTEN.REGISTAR.DBL.T.REGIPLAST 2150	U	50150.2	130,78

■ SIAMP

RESERVOIR A COMMANDE LATERALE PAR CHAÎNE



	DÉSIGNATION	UT	CODE	PPHT (€)	ECOPART (€)
759.0064.29	RESERVOIR HAUT PRIMO 08 BLC 31080618	U	209AD.8	80,44	0,08

Le PPHT comprend l'ecopart (€)

WC

RESERVOIR WC

SIAMP

RESERVOIR DE CHASSE PLASTIQUE



	DÉSIGNATION	UT	CODE	PPHT (€)	ECOPART (€)
759.0060.27	RESERVOIR SEMIBAS PRIMO28 BLC SIAMP 31280610	U	14334.7	80,44	0,08

SIAMP

ACCESSOIRES RESERVOIR DE CHASSE



	DÉSIGNATION	UT	CODE	PPHT (€)	ECOPART (€)
700.0006.20	ENSEMBLE LEVIER PRIMO28/58 SIAMP 34282507	U	84137.9	6,22	0,02
700.0009.85	KIT LIAISON CUVETTE STANDARD SIAMP 34117107	U	3613J.3	12,31	

MECANISME WC ET ROBINET DE CHASSE

GEBERIT

MECANISME DE CHASSE

Complet - Type 290 - 380



	DÉSIGNATION	UT	CODE	PPHT (€)	ECOPART (€)
716.0094.37	MECANISME CHASSE 290-380 DT GEBERIT 283304212	U	7449T.6	117,98	0,02

GEBERIT

MECANISME DE CHASSE

Complet - Type 212



	DÉSIGNATION	UT	CODE	PPHT (€)	ECOPART (€)
702.0034.00	MECANISME DE CHASSE COMPLET 212 244.820.00.1	U	323X1.6	42,52	0,02

GEBERIT

CLOCHE

Complète



	DÉSIGNATION	UT	CODE	PPHT (€)	ECOPART (€)
716.0032.67	CLOCHE COMPLETE GEBERIT 240114001	U	1728C.3	40,86	0,02

GEBERIT

JOINT

De cloche



	DÉSIGNATION	UT	CODE	PPHT (€)	ECOPART (€)
716.0002.30	JOINT DE CLOCHE 63X32 GEBERIT 816418001	U	16508.4	2,87	

Le PPHT comprend l'ecopart (€)

WC

MECANISME WC ET ROBINET DE CHASSE

GEBERIT

ROBINET FLOTTEUR

Unifill compact avec alimentation latérale (Impuls 380)



	DÉSIGNATION	UT	CODE	PPHT (€)	ECOPART (€)
716.0034.14	ROBINET FLOT.UNIFILL P.BATI GEBERIT 281002001	U	07796.6	42,70	0,02

GEBERIT

ROBINET FLOTTEUR

Unifill - Pour réservoir encastré (Impuls 380)



	DÉSIGNATION	UT	CODE	PPHT (€)	ECOPART (€)
716.0050.60	ROBINET FLOTTEUR UNIFILL GEBERIT 240705001	U	06637.3	63,27	0,02



AV1

Mécanisme de chasse complet avec extension



	DÉSIGNATION	UT	CODE	PPHT (€)	ECOPART (€)
762.0043.92	SOUPAPE AV1 P.BATI 38340 GROHE 42320000	U	3522H.6	48,82	0,02



ROBINET FLOTTEUR

Alimentation latérale



	DÉSIGNATION	UT	CODE	PPHT (€)	ECOPART (€)
762.0036.85	ROBINET FLOTTEUR ALIM.LAT. GROHE 37095000	U	74997.8	40,97	0,02



ACCESSOIRES

Joint - En mousse



	DÉSIGNATION	UT	CODE	PPHT (€)	ECOPART (€)
700.0002.44	JOINT CUVETTE MOUSSE 110X70 LAZER 010418	U	62689.5	3,26	



MECANISME DOUBLE TOUCHE

A câble - Avec robinet flotteur



	DÉSIGNATION	UT	CODE	PPHT (€)	ECOPART (€)
759.0048.32	MECANISME DBL.VOL.CABLE UNIV. 3V102 0703120	U	8258D.4	64,44	0,02

Sanitaire
Cuisine

WC

MECANISME WC ET ROBINET DE CHASSE

REGIPLAST**MECAD'OR**

Mécánisme de chasse - Double touche 3/6 Litres à poussoir



	DÉSIGNATION	UT	CODE	PPHT (€)
754.0038.58	MECANISME DBL.CHASSE MECAD'OR REGIPLAST 63	U	62740.6	48,23

REGIPLAST**MECANISME DE CHASSE**

À câble - Adaptable multimarque



	DÉSIGNATION	UT	CODE	PPHT (€)
754.0040.20	MECANISME WC A CABLE+ADAPT REGIPLAST 27000	U	87879.3	50,25

REGIPLAST**ROBINET FLOTTEUR**

Hydraulique - A alimentation latérale



	DÉSIGNATION	UT	CODE	PPHT (€)
754.0022.41	ROBINET FLOTTEUR WC ALIM.LAT./INF 3/8 0900	U	87370.3	28,01

TECE

close to you

CLOCHE DE CHASSE

Avec panier



	DÉSIGNATION	UT	CODE	PPHT (€)	ECOPART (€)
999.0103.23	CLOCHE DE CHASSE AVEC PANIER 9820223	U	87470.0	103,25	0,02

SIAMP**CLASSIC 42**

Mécánisme de chasse simple volume à tirette - Classic 42



	DÉSIGNATION	UT	CODE	PPHT (€)	ECOPART (€)
759.0016.73	MECANISME CHASSE 42 BOUTON CHR SIAMP 32425007	U	36507.2	20,93	0,02

SIAMP**COMPACT 95L**

Robinet flotteur hydraulique compact - A alimentation latérale - Boîte



	DÉSIGNATION	UT	CODE	PPHT (€)	ECOPART (€)
759.0017.97	ROBINET FLOT. COMPACT 95L SIAMP 30950010	U	19887.9	23,98	0,02

WC

MECANISME WC ET ROBINET DE CHASSE

SIAMP**ASP 43**

Mécánisme simple touche à tirette - Pour ancien réservoir Aspirambo Porcher



	DÉSIGNATION	UT	CODE	PPHT (€)	ECOPART (€)
759.0030.74	MECANISME CHASSE ASP 43 SIAMP 32425310	U	7797A.0	30,76	0,02

SIAMP**OPTIMA S/QUIETO OD**

Ensemble mécánisme de chasse + Robinet flotteur - A ouverture différée



	DÉSIGNATION	UT	CODE	PPHT (€)	ECOPART (€)
759.0064.83	MECANISME OPTIMAS+ROB.FL.QUIETO OD 37778010	U	2952U.3	81,06	0,02

SIAMP**OPTIMA S**

Mécánisme de chasse double volume compact à étrier - 95L - Avec robinet flotteur



	DÉSIGNATION	UT	CODE	PPHT (€)	ECOPART (€)
759.0058.77	MECANISME OPTIMA S/95L SIAMP 37940010	U	16399.8	73,48	0,02

SIAMP**MECANISME SPECIFIQUE**

Pour bâti-support - Verso 350



	DÉSIGNATION	UT	CODE	PPHT (€)	ECOPART (€)
700.0015.68	ROBINET FLOTT.95L P.VERSO350 SIAMP 30951007	U	8104K.6	19,62	0,02

SIAMP**MECANISME SPECIFIQUE**

Pour bâti-support - Verso 350 pré-réglé



	DÉSIGNATION	UT	CODE	PPHT (€)	ECOPART (€)
700.0036.96	MECANISME VERSO 350 SIAMP 32454707	U	46903.1	46,22	0,02

SIAMP**ACCESSOIRES**

Clapet pour mécánisme de chasse



	DÉSIGNATION	UT	CODE	PPHT (€)	ECOPART (€)
700.0005.04	CLAPET D.72 COQUE SIAMP 342343220	U	2380G.1	6,32	0,02

Le PPHT comprend l'ecopart (€)

WC

MECANISME WC ET ROBINET DE CHASSE

WATTS

JOINTS ET ACCESSOIRES POUR LES MECANISMES DE CHASSE

Cône WC



	DÉSIGNATION	UT	CODE	PPHT (€)	ECOPART (€)
920.0005.96	CONE BOMBE GM P.CUVETTE 2306P 23014002	U	64038.3	7,94	0,00
920.0003.09	CONE BOMBE PM P.CUVETTE 2404P 23014007	U	36155.0	4,12	0,00

WATTS

JOINTS ET ACCESSOIRES POUR LES MECANISMES DE CHASSE

Raccord Sirius pour cuvette - ø intérieur inférieur ou égal à 50 mm - En vrac



	DÉSIGNATION	UT	CODE	PPHT (€)	ECOPART (€)
920.0004.90	RACCORD SIRIUS P.CUVETTE N.4 405407	U	30375.0	6,53	0,00

ABATTANT WC

Metropolitan

EXCLUSIVITES RICHARDSON PAR GEBERIT

Abattant WC



	DÉSIGNATION	UT	CODE	PPHT (€)	ECOPART (€)
702.0057.95	ABATTANT SEUL ABFR METRO. BLC 00077800000	U	22800.6	72,45	0,01

DURAVIT

STARCK 3

Abattant double - Avec amortisseur de fermeture SoftClose



	DÉSIGNATION	UT	CODE	PPHT (€)	ECOPART (€)
719.0201.60	ABATTANT DBL.STARCK3 BLC SOFTCL. 0063890099	U	9256B.8	252,01	0,01

DURAVIT

D-CODE

Abattant Blanc



	DÉSIGNATION	UT	CODE	PPHT (€)	ECOPART (€)
729.0060.80	ABATTANT DBL.D-CODE CHR/BLC 0067310000	U	0651L.8	76,01	0,01
729.0128.00	ABATTANT DBL.D-CODE BLC SOFTCL. 0067390000	U	0644H.5	160,01	0,01

WC

ABATTANT WC

eazy Collections Exclusives

EXCLUSIVITES RICHARDSON PAR VITRA

Abattant thermoplastic - Charnières soft close



	DÉSIGNATION	UT	CODE	PPHT (€)	ECOPART (€)
592.0040.20	ABATTANT THERM. CHARN./SOFT. EAZY 109-003-909	U	31780.4	50,26	0,01

Jacob Delafon

BRIVE

Abattant polypropylène



	DÉSIGNATION	UT	CODE	PPHT (€)	ECOPART (€)
704.0023.64	ABATTANT P.CUVETTE SUSP.BRIVE JD E4359G-00	U	5627Y.3	29,57	0,02
704.0047.44	ABATTANT BRIVE 2 ECO.BLC JD E70014-00	U	57336.0	59,32	0,02

Jacob Delafon

ODEON

Abattant



	DÉSIGNATION	UT	CODE	PPHT (€)	ECOPART (€)
527.0058.52	ABATTANT ODEON THERMODUR BLC JD E4750-00	U	0289K.0	73,17	0,02

Jacob Delafon

ODEON UP

Abattant - Thermodur



	DÉSIGNATION	UT	CODE	PPHT (€)	ECOPART (€)
704.0059.40	ABATTANT THERMODUR ODEON UP BLC JD 8407K-00	U	9886D.2	74,27	0,02
704.0090.96	ABATTANT ODEON UP DESC.PROG BLC JD 8409K-00	U	1938L.6	113,72	0,02
704.0059.92	ABATTANT ODEON UP COMPACT BLC JD E70009-00	U	9198G.8	74,92	0,02

Jacob Delafon

PATIO

Blanc



	DÉSIGNATION	UT	CODE	PPHT (€)	ECOPART (€)
704.0038.20	ABATTANT PATIO THERMODUR BLC JD E4303-00	U	1558D.6	47,77	0,02
704.0066.04	ABATTANT TH.FR.DE CHUT.PATIO BLC JD E70021-00	U	6172V.6	82,57	0,02

Le PPHT comprend l'ecopart (€)

Les tarifs et disponibilités de nos produits peuvent évoluer sans préavis

RICHARDSON

| 245 |

WC

ABATTANT WC

SIAMP**ESTEREL**

Abattant double



	DÉSIGNATION	UT	CODE	PPHT (€)	ECOPART (€)
759.0068.99	ABATTANT DBL. ESTEREL PREMIUM SIAMP 95900310	U	53640.7	86,26	0,02

SIAMP**MONACO**

Blanc



	DÉSIGNATION	UT	CODE	PPHT (€)	ECOPART (€)
759.0016.37	ABATTANT DBL. MONACO BLC SIAMP 48710117	U	13567.3	20,48	0,02

SIAMP**MOUGINS CLASSIC**

	DÉSIGNATION	UT	CODE	PPHT (€)	ECOPART (€)
759.0038.34	ABATTANT MOUGINS CLASSIC 95901210	U	253PK.3	47,94	0,02

SIAMP**SOPHIA PREMIUM SLIM**

Abattant WC



	DÉSIGNATION	UT	CODE	PPHT (€)	ECOPART (€)
759.0055.25	ABATTANT SOPHIA PREMIUM SLIM THERMO. 10005355	U	299DC.8	69,08	0,02

**SUBWAY 2**

Abattant double - Pour cuvette à fond creux compacte



	DÉSIGNATION	UT	CODE	PPHT (€)	ECOPART (€)
706.0243.20	ABATTANT SUBWAY 2.0 BLC VB 9M69S101	U	9599F.5	304,01	0,01

Vittra**ARKITEKT/NORMUS**

Abattant WC



	DÉSIGNATION	UT	CODE	PPHT (€)
000.0028.00	ABATTANT THERMODUR BLC CHARN.METAL 23-003-001	U	9198F.0	35,00

WC

ABATTANT WC

Vittra**S20**

Abattant WC



	DÉSIGNATION	UT	CODE	PPHT (€)	ECOPART (€)
522.0056.00	ABATTANT PMR70 77003001	U	2472Y.6	70,02	0,02

ACCESSOIRES WC

PELLET**CLASSIQUE**

Distributeur de papier toilette



	DÉSIGNATION	UT	CODE	PPHT (€)	ECOPART (€)
756.0066.12	DISTRIBUTEUR PAP.WC GEANT 310X120MM 878605	U	8352L.3	82,67	0,02

PELLET**GAMME ECONOMIQUE**

Distributeur papier - Avec couvercle



	DÉSIGNATION	UT	CODE	PPHT (€)	ECOPART (€)
756.0011.92	DISTRIBUTEUR PAP.WC HYPEC. PELLET 823512	U	11101.3	14,91	0,01

PELLET**GAMME ECONOMIQUE**

Porte-balayette - A poser



	DÉSIGNATION	UT	CODE	PPHT (€)	ECOPART (€)
756.0013.20	PORTE-BALAYETTE 37CM POLYPROP/BLANC 823109	U	59353.3	16,51	0,01

BROYEUR WC

SFA

Agitateur d'eau

SANIBEST PRO

Broyeur WC, lavabo, douche, bidet



	DÉSIGNATION	UT	CODE	PPHT (€)	ECOPART (€)
717.0972.79	BROYEUR WC SANIBEST PRO SFA B3PRO	U	85863.9	1216,24	0,25

Le PPHT comprend l'ecopart (€)

WC

BROYEUR WC



SANIBROYEUR UP
Broyeur wc adaptable



	DÉSIGNATION	UT	CODE	PPHT (€)	ECOPART (€)
717.0784.10	BROYEUR WC SANIBROYEUR UP SFA SXUPSTD	U	3164H.9	784,35	0,25



SANIBROYEUR PRO UP
Broyeur wc adaptable



	DÉSIGNATION	UT	CODE	PPHT (€)	ECOPART (€)
717.0650.72	BROYEUR WC SANIBROYEUR PRO UP SFA ST3UPSTD	U	3164X.9	813,65	0,25



SANIPLUS UP
Broyeur WC - Evacuation des eaux usées



	DÉSIGNATION	UT	CODE	PPHT (€)	ECOPART (€)
717.0929.83	BROYEURS WC SANIPLUS UP SILENCE SPUPSTD	U	6117A.5	1162,54	0,25



SANICOMPACT 43 SILENCE ECO+
WC sur pied avec broyeur intégré - A fonction Eco+ (double chasse 1,8 l ou 3 l)



	DÉSIGNATION	UT	CODE	PPHT (€)	ECOPART (€)
717.0934.63	BROYEUR WC SANICOMPACT 43 ECO+ SFA C43STD	U	92156.9	1168,54	0,25



SANICOMPACT PRO ECO+
Broyeur WC avec cuvette



	DÉSIGNATION	UT	CODE	PPHT (€)	ECOPART (€)
717.0899.20	BROYEUR WC SANICOMPACT PRO ECO+ A/CUV. C11STD	U	5583P.4	1124,25	0,25



SANIPACK
Broyeur encastrable - Clapet anti-retour extérieur démontable



	DÉSIGNATION	UT	CODE	PPHT (€)	ECOPART (€)
717.1000.20	BROYEUR ADAPTABLE - SANIPACK UP PA2UPSTD	U	6115S.3	1000,45	0,25

Le PPHT comprend l'ecopart (€)

WC

BROYEUR WC



SANISPEED+ SILENCE

Pompe de relevage pour cuisine ou buanderie - Munie d'un refroidisseur pour un fonctionnement optimal



	DÉSIGNATION	UT	CODE	PPHT (€)	ECOPART (€)
717.0743.76	POMPE DE RELEVAGE SANISPEED +SIL.SFA SSPUPSTD	U	3165N.7	929,95	0,25



SILENCE SANIPRO XR UP
Broyeur WC



	DÉSIGNATION	UT	CODE	PPHT (€)	ECOPART (€)
717.0762.40	BROYEUR WC SANIPRO XR UP SILENCE SRUPSTD	U	6118B.2	953,25	0,25



W12PRO
Double cuve



	DÉSIGNATION	UT	CODE	PPHT (€)	ECOPART (€)
717.0663.36	BROYEUR ADAPT.UNIV. W12PRO FRW12PRA6319	U	2138Z.1	829,45	0,25



W30SP SILENCE
Cuvette WC sur pied à broyeur intégré



	DÉSIGNATION	UT	CODE	PPHT (€)	ECOPART (€)
717.1128.90	BROYEUR WATERMATIC W30SP SIL. W30SPXSR_C06_16	U	7434S.5	1129,15	0,25

ROBINETTERIE HYGIENIQUE



MINI KIT
Robinet d'arrêt 2 voies



	DÉSIGNATION	UT	CODE	PPHT (€)
768.0048.00	ROBINET D'ARRET PF FHCR9317	U	70350.4	48,00

WC

ROBINETTERIE HYGIENIQUE



SANITIE-JET

Robinet universel pack "hygiène-WC" - LUXE



	DÉSIGNATION	UT	CODE	PPHT (€)	ECOPART (€)
759.0166.06	PACK HYGIENE WC SANITIE-JET LUX RIQUEUR 07339	U	37307.6	166,09	0,03



KIT COMPLET HYGIENE WC



	DÉSIGNATION	UT	CODE	PPHT (€)	ECOPART (€)
000.0081.18	KIT CPL.DCHTTE HYGIENE WC LAI/CHR 91170000000	U	340M2.3	81,20	0,02

Pour plus d'infos,
consultez
le CAHIER TECHNIQUE
page 14

greensolutions
Votre partenaire énergie

en partenariat avec drapo



Hotline 06 27 52 64 95

www.richardson.fr/services/green-solutions

BIDET

BATI-SUPPORT BIDET

GEBERIT DUOFIX

Bâti-support bidet

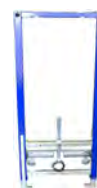

	DÉSIGNATION	UT	CODE	PPHT (€)	ECOPART (€)
716.0399.76	BATI SUSP BIDET DUOFIX 112CM 111.510.00.1	U	348AE.1	399,91	0,15

ROBINETTERIE DE BIDET



EXCLUSIVITES RICHARDSON PAR NOBILI

Mitigeur bidet



	DÉSIGNATION	UT	CODE	PPHT (€)	ECOPART (€)
748.0086.66	MITIGEUR BIDET METRO 2 CHR ME99119/1CR	U	287QS.6	108,34	0,01



BAULOOP

Mitigeur monocommande bidet



	DÉSIGNATION	UT	CODE	PPHT (€)	ECOPART (€)
762.0075.09	MITIGEUR BIDET BAULOOP 23338001	U	304NA.0	83,45	0,02



EUROSMART

Mitigeur bidet monotrou - Taille S



	DÉSIGNATION	UT	CODE	PPHT (€)	ECOPART (€)
762.0100.19	MITIGEUR BIDET EUROSMART 2021 CH3 32928003	U	323WT.1	100,21	0,02



BRIVE

Mitigeur bidet



	DÉSIGNATION	UT	CODE	PPHT (€)	ECOPART (€)
767.0093.84	MITIGEUR BIDET BRIVE 5L/M. A/VID. E75763-4-CP	U	224VJ.0	117,32	0,02

Le PPHT comprend l'ecopart (€)

BIDET

ROBINETTERIE DE BIDET



ORCHIDEATEVE

Robinet bidet



	DÉSIGNATION	UT	CODE	PPHT (€)	ECOPART (€)
768.0081.97	ROBINET ALIM.BID.ORCHIDEATEV.-PAIRE- TZCR300A	U	0404X.5	81,99	0,02

VIDAGE ET SIPHON DE BIDET



SIPHON

Plastique - A culot



	DÉSIGNATION	UT	CODE	PPHT (€)	ECOPART (€)
757.0004.29	SIPHON BIDET TUBE REGL. 1 1/4 LB221 0201002	U	35586.7	5,74	0,02



SIPHON

Plastique - En forme de P



	DÉSIGNATION	UT	CODE	PPHT (€)	ECOPART (€)
757.0005.33	SIPHON BIDET TYPE P 1 1/4 BLC L231 0201015	U	60398.5	7,13	0,02

Pour plus d'infos,
consultez
le CAHIER TECHNIQUE
page 14

EVIER, MEUBLE CUISINE, KITCHENETTE

EVIER INOX



EUROSTAR

Evier à encastrer - 1 cuve - Sans égouttoir



	DÉSIGNATION	UT	CODE	PPHT (€)	ECOPART (€)
744.0139.34	CUVE EUROSTAR ETX610 INX MAN EC FRANKE 017623	U	70190.4	174,19	0,02



RENO

Evier à encastrer - 1 cuve et 1 égouttoir



	DÉSIGNATION	UT	CODE	PPHT (€)	ECOPART (€)
744.0152.66	EVIER 1C.RENO RNX611-86 INOX FRANKE 871673	U	98596.8	190,83	



SPARK

Evier inox à encastrer à bords extraplats Profil Slimtop - 2 cuves - Réversible



	DÉSIGNATION	UT	CODE	PPHT (€)	ECOPART (€)
744.0286.00	EVIER 2C.SPARK INOX SKX621 FRANKE 006457	U	0193S.1	357,53	0,03



SPARK

Evier inox à encastrer à bords extraplats Profil Slimtop - 1 cuve, 1 égouttoir - Réversible



	DÉSIGNATION	UT	CODE	PPHT (€)	ECOPART (€)
744.0252.66	EVIER INOX 100X50CM SKX611-100 FRANKE 006334	U	0483N.8	315,83	



EVIER A ENCASTRER REVERSIBLE

ECO - 1 cuve - Réversible



	DÉSIGNATION	UT	CODE	PPHT (€)	ECOPART (€)
744.0113.30	EVIER ECO INOX 1C.A ENC.D.45CM LIS EEDM045A01	U	57071.6	141,62	



EVIER A ENCASTRER REVERSIBLE

ZOOM - Inox 18/10 - 2 cuves



	DÉSIGNATION	UT	CODE	PPHT (€)	ECOPART (€)
744.0206.49	EVIER A ENC.ZOOM 2C1E 116CM IX SAT EEBM116A06	U	09439.1	258,61	0,50

Le PPHT comprend l'ecopart (€)

Les tarifs et disponibilités de nos produits peuvent évoluer sans préavis

RICHARDSON

| 249 |

EVIER, MEUBLE CUISINE, KITCHENETTE

EVIER INOX

moderna ➤

EVIER A POSER REVERSIBLE
LAVELLI - Inox lisse 18/10 - 1 cuve



	DÉSIGNATION	UT	CODE	PPHT (€)	ECOPART (€)
744.0092.96	EVIER A POS.LAVELLI 1C.NU INOX 80 R60_080_18	U	312T9.6	116,70	0,50
744.0099.52	EVIER A POS.LAVELLI 1C.NU INOX 90 R60_090_18	U	312TA.3	124,90	0,50
744.0108.04	EVIER A POS.LAVELLI 1C.NU INOX 100 R60_100_18	U	312TB.1	135,55	0,50
744.0120.90	EVIER A POS.LAVELLI 1C.NU INOX 120 R60_120_18	U	312TD.7	151,62	0,50

moderna ➤

EVIER A POSER REVERSIBLE
LAVELLI - Inox lisse 18/10 - 2 cuves



	DÉSIGNATION	UT	CODE	PPHT (€)	ECOPART (€)
744.0128.07	EVIER A POS.LAVELLI 2C.NU INOX 120 EPBZ120A00	U	312TN.7	160,59	0,50
744.0173.06	EVIER A POS.LAVELLI 2C.NU INOX 140 EPBV140A00	U	312TL.1	216,82	0,50

moderna ➤

EVIER A POSER REVERSIBLE
POUR CUISINETTE

Avec plaque électrique - Inox



	DÉSIGNATION	UT	CODE	PPHT (€)	ECOPART (€)
744.0287.80	EVIER CUIS.INOX 1C+2P.100CM LISSE CPAE100A02	U	14315.6	363,92	4,17
744.0287.80	EVIER CUIS.INOX 1C+2P.120CM LISSE CPAE120A00	U	1431B.3	363,92	4,17

EVIER DE SYNTHESE

FRANKE

MARIS

Évier à encastrer - Fraganit
Durakleen - 1 grande cuve, 1
égouttoir



	DÉSIGNATION	UT	CODE	PPHT (€)	ECOPART (€)
744.0392.66	EVIER 1C.MARIS MRG611-97 BLC AR.FRANKE 094549	U	4790F.3	491,01	0,18
744.0392.66	EVIER 1C.MARIS MRG611-97 PLATIN.FRANKE 094532	U	4790L.2	491,01	0,18

FRANKE

MARIS

Évier à encastrer - Fraganit
Durakleen - 2 cuves - 1 égouttoir -
Vidage manuel



	DÉSIGNATION	UT	CODE	PPHT (€)	ECOPART (€)
744.0426.00	EVIER 2C.MARIS MRG621 BLC ARTIC FRANKE 095003	U	4792C.8	532,81	0,31
744.0426.00	EVIER 2C.MARIS MRG621 PLATINIUM FRANKE 094990	U	4792K.2	532,81	0,31
744.0426.00	EVIER 2C.MRG 621 NOIR MAT MANU FRANKE 914659	U	3535Z.0	532,81	0,31

EVIER, MEUBLE CUISINE, KITCHENETTE

EVIER DE SYNTHESE

moderna ➤

EVIER A POSER REVERSIBLE
Québec - Résine de synthèse SMC - 1
cuve, 1 égouttoir



	DÉSIGNATION	UT	CODE	PPHT (€)	ECOPART (€)
744.0166.18	EVIER A POS.QUEBEC 1C.SMS NU B.L.M EPAAD90R03D	U	301JP.2	208,73	1,00

moderna ➤

EVIER A POSER REVERSIBLE
Montréal - Résine de synthèse SMC
- 2 cuves



	DÉSIGNATION	UT	CODE	PPHT (€)	ECOPART (€)
745.0162.42	EVIER A POS.MONTREAL 2C.NU BLC.M EPBB120R03D	U	301JX.5	204,03	1,00

moderna ➤

EVIER A POSER REVERSIBLE
Ontario - Résine de synthèse SMC - 1
cuve, 1 égouttoir



	DÉSIGNATION	UT	CODE	PPHT (€)	ECOPART (€)
744.0166.18	EVIER A POS.ONTARIO 1C.NU BLANC M EPPD120R03D	U	301JT.4	208,73	1,00

EVIER CERAMIQUE

■ GEBERIT
ROMANS

Table évier réversible en céramique
à poser - Trous amorcés pour
robinetterie (3 par côté) - 2 cuves, 1
égouttoir - Avec trou amorcé pour
robinetterie



	DÉSIGNATION	UT	CODE	PPHT (€)	ECOPART (€)
702.0225.59	EVIER 2C.ROMANS A POS.120X60 BLC 0069000000	U	75450.7	282,10	0,11

■ GEBERIT
ROYAT

Table-évier réversible en céramique
à poser - Conçu pour intégrer un
lave vaisselle sous l'égouttoir - 1
cuve, 1 égouttoir



	DÉSIGNATION	UT	CODE	PPHT (€)	ECOPART (€)
702.0442.46	EVIER 1C.ROYAT 120X60 BLANC 0069400000	U	27330.0	553,19	0,11

Le PPHT comprend l'ecopart (€)

EVIER, MEUBLE CUISINE, KITCHENETTE

EVIER CERAMIQUE

GEBERIT VALLAURIS

Evier réversible en céramique à encastrer
- 1 cuve, 1 égouttoir - Trou amorcé pour
robinetterie monotrou



	DÉSIGNATION	UT	CODE	PPHT (€)	ECOPART (€)
702.0265.92	EVIER 1C.VALLAURIS 92X50 BLANC 00681000000	U	63859.3	332,51	0,11

MEUBLE SOUS EVIER

aquarine AZUR

Meuble sur pieds - 2 portes



	DÉSIGNATION	UT	CODE	PPHT (€)	ECOPART (€)
745.0152.70	MEUBLE S/ÉVIER 2P.AZUR 90X88,5CM BLANC 200153	U	01631.1	192,71	1,83

aquarine LIBERTY

Meuble sous-éviers - Sélection HLM



	DÉSIGNATION	UT	CODE	PPHT (€)	ECOPART (€)
745.0114.78	MEUBLE S/ÉVIER 2P.LIBERTY 80X60 200183	U	70979.0	145,31	1,83
745.0119.20	MEUBLE S/ÉVIER 2P.LIBERTY 100X60CM BLC 200208	U	66959.8	150,83	1,83
745.0121.80	MEUBLE S/ÉVIER 2P.LIBERTY 120X60CM BLC 200214	U	66964.8	154,87	2,62
745.0123.53	MEUBLE S/ÉVIER 3P.LIBERTY 120X60CM BLC 200230	U	66967.1	157,03	2,62
745.0167.34	MEUBLE S/ÉVIER 3P.LIBERTY 140X60CM BLC 200250	U	67851.6	211,80	2,62
745.0116.59	MEUBLE S/ÉVIER 2P.LIBERTY 90X60CM BLC 200199	U	70980.8	147,57	1,83

Gente meubles

CLIC-CLAC

Meuble sous évier dépliant - 2 portes avec
charnières invisibles



	DÉSIGNATION	UT	CODE	PPHT (€)	ECOPART (€)
745.0152.80	MEUBLE S/ÉV.CLIC CLAC 2P. 80 BLC CLO2.BL801	U	4227E.8	192,83	1,83
745.0152.80	MEUBLE S/ÉV.CLIC CLAC 2P. 90 BLC CLO2.BL901	U	4227F.6	192,83	1,83
745.0152.80	MEUBLE S/ÉV.CLIC CLAC 2P.100 BLC CLO2.BL1001	U	4227G.4	193,62	2,62
745.0152.80	MEUBLE S/ÉV.CLIC CLAC 2P.120 BLC CLO2.BL1201	U	4227H.2	193,62	2,62

EVIER, MEUBLE CUISINE, KITCHENETTE

MEUBLE SOUS EVIER

Gente meubles

CLIC-CLAC

Meuble sous évier dépliant - 3 portes avec
charnières invisibles



	DÉSIGNATION	UT	CODE	PPHT (€)	ECOPART (€)
745.0160.80	MEUBLE S/ÉV.CLIC CLAC 3P.120 BLC CLO3.BL1201	U	4227I.0	203,62	2,62

moderna

MELAMINE

Sur vérins réglables - Pour réfrigérateur
55cm



	DÉSIGNATION	UT	CODE	PPHT (€)	ECOPART (€)
746.0152.81	MEUBLE BAS CLASSIK 2P.140CM BLANC ABC.140D05	U	8483P.9	193,63	2,62

moderna

MELAMINE

Sur vérins réglables - Pour réfrigérateur
48 ou 55 cm (avec fileur amovible)



	DÉSIGNATION	UT	CODE	PPHT (€)	ECOPART (€)
744.0121.38	MEUBLE BAS CLASSIK 1P.120CM BLANC ABC.120D05	U	8159K.0	153,56	1,83
744.0121.38	MEUBLE BAS CLASSIK 1P.100CM BLANC ABC.100D05	U	1100C.1	153,56	1,83

moderna

MELAMINE

Sur vérins réglables - Pour lave-vaisselle
60cm



	DÉSIGNATION	UT	CODE	PPHT (€)	ECOPART (€)
746.0144.26	MEUBLE S/ÉV. P/LAVE-VAIS. 120 BLC ABCF120D02	U	5939H.8	182,15	1,83
744.0145.33	MEUBLE SS/ÉV.2P.PRIMO 140 BLANC LV ABCF140D02	U	0054K.3	184,28	2,62

moderna

ONELIA

Meuble cuisinette 2 portes - Pour lave-
vaisselle 60cm



	DÉSIGNATION	UT	CODE	PPHT (€)	ECOPART (€)
744.0145.33	MEUBLE SS/ÉV.2P.PRIMO 140 BLANC LV ABCF140D02	U	0054K.3	184,28	2,62

Le PPHT comprend l'ecopart (€)

Les tarifs et disponibilités de nos produits peuvent évoluer sans préavis

RICHARDSON

| 251 |

EVIER, MEUBLE CUISINE, KITCHENETTE

ROBINETTERIE CUISINE



EXCLUSIVITES RICHARDSON PAR NOBILI

Mitigeur évier - Bec mobile



	DÉSIGNATION	UT	CODE	PPHT (€)	ECOPART (€)
748.0089.33	MITIGEUR EV.METRO 2.CHR MEE101113/25CR	U	287QT.4	111,67	0,01



EXCLUSIVITES RICHARDSON PAR NOBILI

Mitigeur évier - Bec haut carré



	DÉSIGNATION	UT	CODE	PPHT (€)	ECOPART (€)
748.0129.33	MITIGEUR EV.HT CA.METRO 2.CHR ME112134CR	U	287QU.1	161,67	0,01



EXCLUSIVITES RICHARDSON PAR NOBILI

Mitigeur évier - Bec haut rond



	DÉSIGNATION	UT	CODE	PPHT (€)	ECOPART (€)
748.0129.33	MITIGEUR EV.HT RD METRO 2.CHR ME112133CR	U	287QV.9	161,67	0,01



EXCLUSIVITES RICHARDSON PAR NOBILI

Mitigeur évier - Avec douchette extractible 2 jets



	DÉSIGNATION	UT	CODE	PPHT (€)	ECOPART (€)
748.0139.93	MITIGEUR EV.DCHET ZJ.METRO 2. CHR ME112117CR	U	287QW.7	174,92	0,01



EXCLUSIVITES RICHARDSON PAR NOBILI

Mitigeur évier - Semi-pro - Avec douchette 2 jets



	DÉSIGNATION	UT	CODE	PPHT (€)	ECOPART (€)
748.0214.66	MITIGEUR EV.S.PRO METRO 2.CHR ME112300/3CR	U	287QX.5	268,34	0,01

EVIER, MEUBLE CUISINE, KITCHENETTE

ROBINETTERIE CUISINE



EXCLUSIVITES RICHARDSON PAR PAINI FRANCE

Mitigeur évier bec haut



	DÉSIGNATION	UT	CODE	PPHT (€)	ECOPART (€)
592.0055.60	MITIGEUR EV. BEC HAUT CHR EAZY 02CR5702SEZPT	U	365XF.6	55,61	0,01



EXCLUSIVITES RICHARDSON PAR PAINI FRANCE

Mitigeur évier bec standard



	DÉSIGNATION	UT	CODE	PPHT (€)	ECOPART (€)
592.0045.20	MITIGEUR EVIER BEC STAND. C3 EAZY EZCR573C3	U	3772K.8	56,51	0,01



EXCLUSIVITES RICHARDSON PAR PAINI FRANCE

Mitigeur évier mural



	DÉSIGNATION	UT	CODE	PPHT (€)	ECOPART (€)
592.0080.72	MITIGEUR EVIER MURAL EAZY EZCR501C2	U	3773L.5	100,91	0,01



EXCLUSIVITES RICHARDSON PAR NOBILI

Mitigeur évier - Bec haut rond



	DÉSIGNATION	UT	CODE	PPHT (€)	ECOPART (€)
593.0193.12	MITIGEUR EV.UPCITY BEC/HAUT INOX UPC1121133IX	U	200NW.7	257,51	0,01



EXCLUSIVITES RICHARDSON PAR NOBILI

Mitigeur évier - Semi-pro avec douchette et flexible caoutchouc noir



	DÉSIGNATION	UT	CODE	PPHT (€)	ECOPART (€)
593.0262.50	MITIGEUR EV.UPCITY HT NR CHR UPC1121400/1CR	U	200NZ.2	350,01	0,01
593.0418.12	MITIGEUR EV.UPCITY HT NR INOX UPC1121400/1IX	U	200PO.6	557,51	0,01

Le PPHT comprend l'ecopart (€)

EVIER, MEUBLE CUISINE, KITCHENETTE

ROBINETTERIE CUISINE



EXCLUSIVITES RICHARDSON PAR NOBILI

Mitigeur évier - Semi-pro-douchette 2 jets ressort laiton



DÉSIGNATION	UT	CODE	PPHT (€)	ECOPART (€)
593.0410.00 MITIGEUR EV.UPCITY SEMI-PRO INOX UPC121300IX	U	200NY.3	546,67	0,01



BAULOOP

Mitigeur évier monotrou sur plage - Bec orientable



DÉSIGNATION	UT	CODE	PPHT (€)	ECOPART (€)
762.0101.08 MITIGEUR EV. BAULOOP BEC C CHR 31368001	U	265PF.6	112,33	0,02



EUROSMART

Mitigeur évier - Bec tube pivotant 150°



DÉSIGNATION	UT	CODE	PPHT (€)	ECOPART (€)
762.0174.37 MITIGEUR EV. EUROSMART 2021 BEC U 30567000	U	304YY.8	174,39	0,02



EUROSMART

Mitigeur évier - Bec haut pivotant



DÉSIGNATION	UT	CODE	PPHT (€)	ECOPART (€)
762.0130.04 MITIGEUR EV. EUROSMART 2021 BEC HAUT 32223003	U	299EA.1	130,06	0,02



EUROSMART

Mitigeur évier - Bec moulé pivotant



DÉSIGNATION	UT	CODE	PPHT (€)	ECOPART (€)
762.0124.12 MITIGEUR EV. EUROSMART BEC BAS CHR 32221003	U	287X3.9	124,14	0,02

EVIER, MEUBLE CUISINE, KITCHENETTE

ROBINETTERIE CUISINE



EUROSMART

Mitigeur évier - Bec moulé bas pivotant



DÉSIGNATION	UT	CODE	PPHT (€)	ECOPART (€)
762.0164.92 MITIGEUR EV.EUROSMART DCHTTE CHR 30355001	U	287X5.4	183,26	0,02

hansgrohe

FOCUS

Mitigeur évier - Bec L



DÉSIGNATION	UT	CODE	PPHT (€)	ECOPART (€)
765.0221.04 MITIGEUR EV.FOCUS CHR H.GROHE 31817000	U	2561Q.5	245,62	0,02

hansgrohe

FOCUS

Mitigeur évier - Bec orientable à 150°



DÉSIGNATION	UT	CODE	PPHT (€)	ECOPART (€)
765.0286.79 MITIGEUR EV. FOCUS M41+DCHTTE 2J CHR 31815000	U	1623V.2	318,67	0,02

hansgrohe

FOCUS E²

Mitigeur évier - Bec orientable à 360°



DÉSIGNATION	UT	CODE	PPHT (€)	ECOPART (€)
765.0134.72 MITIGEUR EV.FOCUS M41 C3 1J H.GROHE 31816000	U	4466K.7	149,71	0,02

hansgrohe

LOGIS

Mitigeur évier



DÉSIGNATION	UT	CODE	PPHT (€)	ECOPART (€)
765.0111.24 MITIGEUR EV.LOGIS M31 KM120 H.GROHE 71837000	U	5823Q.2	123,62	0,02

hansgrohe

M42

Mitigeur évier ComfortZone 120



DÉSIGNATION	UT	CODE	PPHT (€)	ECOPART (€)
765.0142.61 MITIGEUR EV. M42 H120 ECO C3 71805000	U	208UJ.4	158,47	0,02

Le PPHT comprend l'ecopart (€)

EVIER, MEUBLE CUISINE, KITCHENETTE

ROBINETTERIE CUISINE

hansgrohe

M42

Mitigeur évier avec douchette



	DÉSIGNATION	UT	CODE	PPHT (€)	ECOPART (€)
765.0191.49	MITIGEUR EV. M42 H150 A/DCHTTE 71814000	U	208UK.2	212,79	0,02

hansgrohe

TALIS M52

Mitigeur de cuisine 170 - Avec douchette extractible 2 jets



	DÉSIGNATION	UT	CODE	PPHT (€)	ECOPART (€)
765.0326.97	MITIGEUR EV.TALIS M52 170 2J H.GROHE 32841000	U	5549I.8	363,32	0,02

hansgrohe

TICA

Exclusivité RICHARDSON - Mitigeur de cuisine ComfortZone 160



	DÉSIGNATION	UT	CODE	PPHT (€)	ECOPART (€)
765.0112.46	MITIGEUR CUISINE 160 TICA 1JET CHR 14904000	U	319KA.1	140,59	0,01

hansgrohe

TICA

Exclusivité RICHARDSON - Mitigeur de cuisine ComfortZone 260



	DÉSIGNATION	UT	CODE	PPHT (€)	ECOPART (€)
765.0161.46	MITIGEUR CUISINE 260 TICA 1JET CHR 14905000	U	319KB.9	201,84	0,01

hansgrohe

VERNIS BLEND M35

Mitigeur de cuisine 210



	DÉSIGNATION	UT	CODE	PPHT (€)	ECOPART (€)
765.0141.58	MITIGEUR EV. VERNIS BLEND M35 1J CHR 71870000	U	331VF.0	157,33	0,02

hansgrohe

ZESIS M33

Mitigeur cuisine 150, CoolStart, EcoSmart



	DÉSIGNATION	UT	CODE	PPHT (€)	ECOPART (€)
765.0134.68	MITIGEUR CUIS.150 ZESIS M33 CHR/CO/S 74813000	U	338YX.8	134,70	0,02

EVIER, MEUBLE CUISINE, KITCHENETTE

ROBINETTERIE CUISINE

Jacob Delafon
PARIS

BRIVE

Mitigeur évier



	DÉSIGNATION	UT	CODE	PPHT (€)	ECOPART (€)
767.0092.64	MITIGEUR EV.BRIVE BEC PROF/C3 CHR E78115-4-CP	U	224VS.4	115,82	0,02
767.0090.68	MITIGEUR EVIER BRIVE BEC TUBE CHR E75770-4-CP	U	224VM.4	113,37	0,02

Jacob Delafon
PARIS

GINKO CD

Equerre de renfort



	DÉSIGNATION	UT	CODE	PPHT (€)
704.0003.00	EQUERRE RENFORT GINKO CD CHR JD E75499-NF	U	20738.1	3,75

Jacob Delafon
PARIS

JULY

Mitigeur évier - Avec levier métal



	DÉSIGNATION	UT	CODE	PPHT (€)	ECOPART (€)
534.0095.88	MITIGEUR EV. JULY CHR E16084-4-CP	U	3266I.4	119,87	0,02

Jacob Delafon
PARIS

JULY

Mitigeur évier - Avec limiteur de débit sensitif



	DÉSIGNATION	UT	CODE	PPHT (€)	ECOPART (€)
767.0093.92	MITIGEUR EV. JULY BEC TUBE CHR JD E5243-CP	U	9921C.1	117,42	0,02

NOBILI

CLINIQUE

Mitigeur évier



	DÉSIGNATION	UT	CODE	PPHT (€)	ECOPART (€)
778.0118.40	MITIGEUR EVIER MONO PMR AS27113/1TDCR	U	181YG.4	148,00	

Patri France
ROBINETTERIE

ORCHIDEA

Robinet évier mural



	DÉSIGNATION	UT	CODE	PPHT (€)	ECOPART (€)
768.0055.18	ROBINET SPL.EV.MUR.ORCHIDEATEVE.CH.PF TZCR517A	U	5256H.3	68,99	0,02

Le PPHT comprend l'ecopart (€)

EVIER, MEUBLE CUISINE, KITCHENETTE

ROBINETTERIE CUISINE



ORCHIDEA TEVERE

Mélangeur évier mural



	DÉSIGNATION	UT	CODE	PPHT (€)	ECOPART (€)
768.0093.58	MELANGEUR EV.MUR.ORCHIDEATEV. CHR PF TZCR501A	U	52630.1	116,99	0,02



VENTUS

Mitigeur évier standard



	DÉSIGNATION	UT	CODE	PPHT (€)	ECOPART (€)
768.0113.00	MITIGEUR EV.VENTUS BEC STANDARD 93CR573PILOT	U	7222V.4	113,00	

VIDAGE ET SIPHON CUISINE



ACCESSOIRES

Bouchon-chaînette - Avec chaînette 30 cm



	DÉSIGNATION	UT	CODE	PPHT (€)	ECOPART (€)
700.0002.20	BOUCHON PVC+CHAINE DM30 40X45	U	38434.7	2,93	
700.0003.43	BOUCHON PVC+CHAINE DM30 45X50	U	48202.6	4,57	



BONDE

A panier ø 114 mm - Pour évier inox, grès et synthèse - 1 cuve - Commande auto rotative - Avec trop-plein



	DÉSIGNATION	UT	CODE	PPHT (€)	ECOPART (€)
757.0080.17	BONDE A PANIER AUTO AV.TP D114 532 0204118	U	67002.6	106,91	0,02



BONDE

A panier ø 114 mm - Pour évier inox, grès et synthèse - 1 cuve - Panier manuel - Avec trop-plein



	DÉSIGNATION	UT	CODE	PPHT (€)	ECOPART (€)
757.0051.22	BONDE A PANIER MANU AV.TP D114 514 0204123	U	66988.7	68,32	0,02

EVIER, MEUBLE CUISINE, KITCHENETTE

VIDAGE ET SIPHON CUISINE



BONDE

A panier ø 114 mm - Pour évier inox, grès et synthèse - 1 cuve - Panier manuel - Sans trop-plein



	DÉSIGNATION	UT	CODE	PPHT (€)	ECOPART (€)
757.0041.80	BONDE A PANIER MANU SS TP D114 513 0204122	U	66974.7	55,75	0,02



BONDE

Laiton ø 84 mm - Pour évier grès et synthèse de perçage ø 60 mm - 1 cuve - Bouchon chaînette - Sans trop-plein



	DÉSIGNATION	UT	CODE	PPHT (€)	ECOPART (€)
757.0021.16	BONDE A BOUCHON EV.GRES D84 LAIT.1060 0501003	U	17007.6	28,24	0,02



BONDE

Plastique ø 70 mm - Pour évier inox perçage ø 60 mm - 1 cuve - Avec surverse ABS blanc - Sans trop-plein



	DÉSIGNATION	UT	CODE	PPHT (€)	ECOPART (€)
757.0017.24	BONDE A SURVERSE D70 ABS BLC 5582 0204175	U	79634.2	23,00	0,02



BONDE

Plastique ø 70 mm - Pour évier inox perçage ø 60 mm - 1 cuve - Bouchon-chaînette - Avec trop-plein souple



	DÉSIGNATION	UT	CODE	PPHT (€)	ECOPART (€)
757.0010.15	BONDE AV.TP.P.EVIER INOX 556 0204015	U	09763.4	13,55	0,02



BONDE

Plastique ø 70 mm - Pour évier inox perçage ø 60 mm - 1 cuve - Bouchon-chaînette - Sans trop-plein



	DÉSIGNATION	UT	CODE	PPHT (€)	ECOPART (€)
757.0008.37	BONDE BOUCH+CHAINET.P.EVIER INOX 558 0204014	U	09764.2	11,18	0,02

Le PPHT comprend l'ecopart (€)

EVIER, MEUBLE CUISINE, KITCHENETTE

VIDAGE ET SIPHON CUISINE

Nicoll
by aliaxis

BONDE

Plastique ø 70 mm - Pour évier inox perçage ø 60 mm
- 2 cuves - Bouchon-chaînette - Avec trop-plein



	DÉSIGNATION	UT	CODE	PPHT (€)	ECOPART (€)
757.0037.69	VIDAGE EV.CPLT 2C.INOX+SIPHON C5911 0204311	U	02185.7	50,27	0,02

Nicoll
by aliaxis

BONDE

Plastique ø 84 mm - Pour évier grès et synthèse - 1 cuve
- Bouchon-chaînette - Sans trop-plein



	DÉSIGNATION	UT	CODE	PPHT (€)	ECOPART (€)
757.0011.67	BONDE A BOUCHON EVIER GRES D84 560 0204004	U	32028.3	15,58	0,02

Nicoll
by aliaxis

BONDE

Plastique ø 84 mm - Pour évier grès et synthèse - 1 cuve - Grille - Sans trop-plein



	DÉSIGNATION	UT	CODE	PPHT (€)	ECOPART (€)
757.0011.67	BONDE A GRILLE EVIER GRES D84 5651 0204005	U	16238.8	15,58	0,02

Nicoll
by aliaxis

BONDE

Plastique ø 84 mm - Pour évier grès et synthèse
- 1 cuve - Bouchon-chaînette - Avec trop-plein
rectangulaire



	DÉSIGNATION	UT	CODE	PPHT (€)	ECOPART (€)
757.0022.10	VIDAGE EV.1C+TP.RECT.+BOUCH.D84 20404 0204601	U	28916.5	29,49	0,02

Nicoll
by aliaxis

EASYPHON

Siphon d'évier à joints intégrés - Réglable en hauteur
(133 - 192 mm)



	DÉSIGNATION	UT	CODE	PPHT (€)	ECOPART (€)
757.0005.97	SIPHON EVIER BI-MAT.1 1/2 D040 BM552 0224286	U	1495J.0	7,98	0,02

EVIER, MEUBLE CUISINE, KITCHENETTE

VIDAGE ET SIPHON CUISINE

Nicoll
by aliaxis

EASYPHON

Siphon d'évier à joints intégrés - Réglable en
hauteur (177 - 22 mm) - Avec prise machine à laver



	DÉSIGNATION	UT	CODE	PPHT (€)	ECOPART (€)
757.0012.14	SIPHON EV.EASYPHON M.A.L 1 1/2 BM53 0224360	U	9987K.6	16,20	0,02

Nicoll
by aliaxis

SIPHON

Laiton - Forme "S" - Grand débit



	DÉSIGNATION	UT	CODE	PPHT (€)	ECOPART (€)
757.0042.46	SIPHON EVIER/BAIGN.TUBE LAITON 1055 0501001	U	17001.9	56,63	0,02

Nicoll
by aliaxis

SIPHON

Laiton - A culot démontable réglable en hauteur (149 -
222 mm)



	DÉSIGNATION	UT	CODE	PPHT (€)	ECOPART (€)
757.0051.40	SIPHON EV.1 1/2 LAIT.CHR.MAT 1053 0501008	U	18377.2	68,56	0,02

Nicoll
by aliaxis

SIPHON

Plastique - A culot démontable réglable en hauteur (137
- 177 mm)



	DÉSIGNATION	UT	CODE	PPHT (€)	ECOPART (€)
757.0003.68	SIPHON EV.TUBE REGLABLE G 1 1/2 552 0204002	U	35587.5	4,92	0,02

Nicoll
by aliaxis

TUBULURE DE RACCORDEMENT

Plastique - Pour évier 1 cuve



	DÉSIGNATION	UT	CODE	PPHT (€)	ECOPART (€)
757.0011.88	TUBULURE GAIN DE PLACE SORT.ARR. 5258 0204183	U	73211.5	11,90	0,02

Nicoll
by aliaxis

TUBULURE DE RACCORDEMENT

Plastique - Pour évier 2 cuves égales



	DÉSIGNATION	UT	CODE	PPHT (€)	ECOPART (€)
757.0007.85	TUBULURE EVIER 2 CUVES EGALES 561 0204016	U	35594.1	10,49	0,02

Le PPHT comprend l'ecopart (€)

EVIER, MEUBLE CUISINE, KITCHENETTE

VIDAGE ET SIPHON CUISINE

Nicoll
by allaxis

TUBULURE DE RACCORDEMENT
Plastique - Pour évier 1 bac et 2 bacs



	DÉSIGNATION	UT	CODE	PPHT (€)	ECOPART (€)
757.0014.01	TUBULURE ESPACE UNIV.EVIER 2CUVES 569 0204981	U	77355.6	18,70	0,02

wirquin
PRO

VIDAGE EVIER
Siphon d'évier réglable



	DÉSIGNATION	UT	CODE	PPHT (€)	ECOPART (€)
714.0006.01	SIPHON EV. NEO SINK AIR SYSTEME 30722146	U	193HY.6	7,53	0,02
759.0014.76	SIPHON EV.MAL.NEO AIR REGL.WIROUIN 30722145	U	202TE.7	18,45	

Pour plus d'infos,
consultez
le CAHIER TECHNIQUE
page 14

COLLECTIVITE POINT D'EAU

VASQUE, LAVABO ET LAVE-MAINS

■ GEBERIT
PUBLICA

Timbre d'office



	DÉSIGNATION	UT	CODE	PPHT (€)	ECOPART (€)
702.0165.02	TIMBRE OFFICE PUBLICA S/TP 50X40 360050000	U	254BC.5	206,38	0,11
702.0294.66	TIMBRE OFFICE A/TP 70X50 361370000	U	254BH.4	368,44	0,11

Jacob Delafon
PARIS

DUO

Lavabo collectif en céramique à
poser sur console



	DÉSIGNATION	UT	CODE	PPHT (€)	ECOPART (€)
704.0171.00	LAVABO DUO 100X37CM BLC JD EN290-00	U	10909.0	213,81	0,06

Jacob Delafon
PARIS

MIDEO

Lave-mains autoportant - Dossier en céramique -
Plages plates de pose - 1 trou percé



	DÉSIGNATION	UT	CODE	PPHT (€)	ECOPART (€)
704.0050.52	LAVE-MAINS BRIVE 2 MIDEO 45X35 BLC E4338-00	U	3252L.5	63,21	0,06

Jacob Delafon
PARIS

ACCESSOIRES

DUO - Dossier



	DÉSIGNATION	UT	CODE	PPHT (€)	ECOPART (€)
704.0117.36	DOSSIER P.LAV.DUO 2 BLC JD EN281-00	U	20768.8	146,76	0,06

VIDOIR ET DEVERSOIR

■ GEBERIT
PUBLICA

Déversoir mural - Avec bonde 1"1/2 à
écoulement libre



	DÉSIGNATION	UT	CODE	PPHT (€)	ECOPART (€)
702.0238.94	DEVERSOIR MURAL PUBLICA BLC 04750000000	U	28696.3	298,79	0,11

Le PPHT comprend l'ecopart (€)

Les tarifs et disponibilités de nos produits peuvent évoluer sans préavis

RICHARDSON

| 257 |

COLLECTIVITE POINT D'EAU

VIDOIR ET DEVERSOIR

■ GEBERIT PUBLICA LABORATORY

Cuve laboratoire



	DÉSIGNATION	UT	CODE	PPHT (€)	ECOPART (€)
702.0242.17	CUVE LABORATOIRE 60X45 PUBLICA 500.921.00.1	U	262V4.2	302,82	0,11



NORMA

Déversoir mural - Percé pour grille porte-seau



	DÉSIGNATION	UT	CODE	PPHT (€)
704.0164.12	VIDOIR MURAL NORMA NU PERCE BLC JD E1899-00	U	11544.4	205,15



NORMA

Accessoires pour vidoir Norma - Grille porte-seau



	DÉSIGNATION	UT	CODE	PPHT (€)
704.0101.52	GRILLE PORTE-SEAU P.1899 JD E5597-NF	U	11546.9	126,90



POSTE D'EAU PVC

Fixation murale



	DÉSIGNATION	UT	CODE	PPHT (€)	ECOPART (€)
757.0157.46	POSTE D'EAU MUR.49.5X39.5 BLC POSTOB	U	58752.7	209,97	0,02

ROBINETTERIE COLLECTIVITE POINT D'EAU

DELABIE MONOFOOT

Robinet de lavabo instantané à commande au pied



	DÉSIGNATION	UT	CODE	PPHT (€)
771.0135.47	ROBINET MONOFOOT MM1/2 ECRU CB DEL 736001	U	73408.7	159,38

COLLECTIVITE POINT D'EAU

ROBINETTERIE COLLECTIVITE POINT D'EAU

DELABIE MIXFOOT

Mitigeur de lavabo instantané à commande au pied



	DÉSIGNATION	UT	CODE	PPHT (€)
771.0178.04	MITIGEUR MIXFOOT AU SOL SANS ECRU DEL 739100	U	1060A.3	178,04

DELABIE PREMIX COMPACT

Mitigeur thermostatique - Pour distribution d'eau mitigée de 30 à 60 °C



	DÉSIGNATION	UT	CODE	PPHT (€)
771.0084.85	MITIGEUR THER. PREMIX COMPACT 1/2 DEL 733015	U	6068A.4	99,82
771.0084.85	MITIGEUR THER. PREMIX COMPACT 3/4 DEL 733020	U	6071A.9	99,82

DELABIE TEMPOGENOU

Robinet poussoir de lavabo à commande fémorale



	DÉSIGNATION	UT	CODE	PPHT (€)
771.0091.45	ROBINET DR 1/2 TEMPOGENOU DEL 735400	U	1051A.4	107,59

DELABIE TEMPOSOFT MIX

Mitigeur de lavabo temporisé sur vasque - Déclenchement souple



	DÉSIGNATION	UT	CODE	PPHT (€)
771.0168.74	MITIGEUR LAV. TEMPOSOFT MIX 2 CHR DEL 742500	U	5721K.5	198,52

DELABIE TEMPOSOFT 2

Robinet poussoir de lavabo mural - Sur plage - Brise-jet antitartre inviolable



	DÉSIGNATION	UT	CODE	PPHT (€)
771.0077.55	ROBINET LAV. TEMPOSOFT 2 CHR DEL 740500	U	5721L.3	91,23

DELABIE TEMPOSTOP

Robinet poussoir de lavabo sur vasque



	DÉSIGNATION	UT	CODE	PPHT (€)
771.0069.66	ROBINET LAV. TEMPOSTOP DEL 745100	U	91985.2	81,95

Le PPHT comprend l'ecopart (€)

COLLECTIVITE POINT D'EAU

ROBINETTERIE COLLECTIVITE POINT D'EAU

DELABIE

TEMPOSTOP

Robinet poussoir de lavabo mural



	DÉSIGNATION	UT	CODE	PPHT (€)
771.0052.45	ROBINET LAV.TEMPOSTOP MURAL DEL 746000	U	15771.9	61,71

DELABIE

TEMPOMATIC MIX 4

Mitigeur électronique lavabo - Avec manette standard



	DÉSIGNATION	UT	CODE	PPHT (€)
771.0327.54	MITIGEUR LAV.TEMPOMATIC MIX4 PILES 6V 490006	U	5297C.5	385,34

DELABIE

TEMPOMIX

Mitigeur lavabo - Mitigeur de lavabo temporisé monocommande sur vasque



	DÉSIGNATION	UT	CODE	PPHT (€)
771.0196.67	MITIGEUR LAV. TEMPOMIX DEL 795000	U	61622.7	231,38

DELABIE

TEMPOMIX 2

Mitigeur lavabo - Mitigeur de lavabo temporisé sur vasque



	DÉSIGNATION	UT	CODE	PPHT (€)
771.0191.56	MITIGEUR LAV. TEMPOMIX 2 ROB/ARRET DEL 700000	U	76201.3	225,37

DELABIE

BEC LAVABO

Bec col de cygne M 1/2"



	DÉSIGNATION	UT	CODE	PPHT (€)
771.0036.61	BEC LAVABO+AERATEUR M1/2 L150 DEL 967152	U	34824.3	43,07

DELABIE

BEC LAVABO



	DÉSIGNATION	UT	CODE	PPHT (€)
771.0075.01	BEC LAVABO+AERATEUR M1/2 L140 DEL 981142	U	71983.1	88,25

COLLECTIVITE POINT D'EAU

ROBINETTERIE COLLECTIVITE POINT D'EAU

DELABIE

ACCESSOIRES ROBINETTERIE

Rallonge robinet mural



	DÉSIGNATION	UT	CODE	PPHT (€)
771.0011.24	RALLONGE MF3/4 L25 CHR DEL 822220	U	08389.9	13,22
771.0013.79	RALLONGE MF3/4 L50 CHR DEL 822520	U	48465.9	16,22
771.0011.24	RALLONGE MF1/2 L50 CHR DEL 822515	U	78985.9	13,22
771.0008.17	RALLONGE MF1/2 L25 CHR DEL 822215	U	25901.0	9,61

DELABIE

ACCESSOIRES ROBINETTERIE

Rosace - Plate



	DÉSIGNATION	UT	CODE	PPHT (€)
771.0017.82	ROSACE PLATE 30/65 DEL 292065.2P	U	13327.2	20,96

DELABIE

ACCESSOIRES ROBINETTERIE

Rosace - Plate à moulure - Pour robinet 1/2"



	DÉSIGNATION	UT	CODE	PPHT (€)
771.0007.78	ROSACE PLATE P.ROBINET 1/2 DEL 292015.2P	U	41769.1	9,15

DELABIE

ACCESSOIRES ROBINETTERIE

Tempostop - Temporisation ~7 secondes



	DÉSIGNATION	UT	CODE	PPHT (€)
771.0060.97	ROBINET LAV.TEMPOSTOP DEL 748126	U	5497R.5	60,97

NOBILI

MITIGEUR

Pour lavabo - Sans vidage



	DÉSIGNATION	UT	CODE	PPHT (€)
778.0133.60	MITIGEUR LAV. POIGNEE CLIN. CHR AS87118/2CCR	U	17422.9	167,00

PRESTO®

NEO/DUO

Robinet mural



	DÉSIGNATION	UT	CODE	PPHT (€)	ECOPART (€)
770.0045.55	ROBINET SIMPLE MURAL NEO FROID PRESTO 66000	U	8489U.2	56,95	0,01

Le PPHT comprend l'ecopart (€)

Les tarifs et disponibilités de nos produits peuvent évoluer sans préavis

RICHARDSON

259

COLLECTIVITE POINT D'EAU

ROBINETTERIE COLLECTIVITE POINT D'EAU

PRESTO®

NEO/DUO

Robinet sur plage



	DÉSIGNATION	UT	CODE	PPHT (€)	ECOPART (€)
770.0063.43	ROBINET SIMPLE SUR PLAGE NEO PRESTO 65000	U	8489R.9	79,30	0,01

PRESTO®

NEO S

Mitigeur temporisé



	DÉSIGNATION	UT	CODE	PPHT (€)	ECOPART (€)
770.0165.32	MITIGEUR S/P NEO S PRESTO 68403	U	5999S.1	206,66	0,01

PRESTO®

NEO S

Robinet lavabo



	DÉSIGNATION	UT	CODE	PPHT (€)	ECOPART (€)
770.0074.44	ROBINET NEO S FROID CHR PRESTO 65200	U	5998X.6	93,06	0,01

PRESTO®

NEO PRESTO

Mitigeur temporisé



	DÉSIGNATION	UT	CODE	PPHT (€)	ECOPART (€)
770.0155.30	MITIGEUR S/PL NEO PRESTO 68400	U	5998Y.4	194,14	0,01

PRESTO®

PRESTO 504

Robinet lavabo simple mural temporisé - Arrivée mâle 1/2" - Eau froide



	DÉSIGNATION	UT	CODE	PPHT (€)	ECOPART (€)
770.0053.67	ROBINET LAV.SPL.MUR.504 EFRDE 1/2PRESTO 63000	U	0795A.7	67,10	0,01

PRESTO®

PRESTO 504 S

Robinet mural système antiblocage - Arrivée mâle 3/8"



	DÉSIGNATION	UT	CODE	PPHT (€)	ECOPART (€)
770.0066.58	ROBINET LAV.SPL.MUR.504S EF 1/2 PRESTO 63100	U	0798A.4	83,24	0,01

COLLECTIVITE POINT D'EAU

ROBINETTERIE COLLECTIVITE POINT D'EAU

PRESTO®

PRESTO 520

Robinet bi-pédale - 3 l/mn à 3 bars



	DÉSIGNATION	UT	CODE	PPHT (€)	ECOPART (€)
770.0156.73	ROBINET BI-PEDALE PRESTO530E CHR PRESTO 23644	U	0666W.0	195,92	0,01

PRESTO®

PRESTO 605

Robinet lavabo temporisé sur plage - Pour eau froide - Alimentation 1/2"



	DÉSIGNATION	UT	CODE	PPHT (€)	ECOPART (€)
770.0072.78	ROBINET LAV.TEMPO S/G 605 EF CHR PRESTO 64602	U	0791A.1	90,98	0,01

PRESTO®

PRESTO 612

Robinet lavabo mural temporisé - Alimentation mâle 1/2" - Eau chaude



	DÉSIGNATION	UT	CODE	PPHT (€)	ECOPART (€)
770.0080.71	ROBINET LAV.SPL.BEC TOURN.612 EF PRESTO 31815	U	8638C.7	100,90	0,01

PRESTO®

PRESTO 705

Robinet simple sur plage - Raccordement 1/2"



	DÉSIGNATION	UT	CODE	PPHT (€)	ECOPART (€)
770.0089.32	ROBINET LAV.SPL.S/G 705 EC OU EF PRESTO 64652	U	1023A.9	111,66	0,01

PRESTO®

PRESTO 712

Robinet commande fémorale - Raccordement 1/2"



	DÉSIGNATION	UT	CODE	PPHT (€)	ECOPART (€)
770.0086.94	COMMANDE FEMORALE 39CM PRESTO712 PRESTO 31683	U	32607.4	108,68	0,01

PRESTO®

PRESTO 3000

Mitigeur sur gorge S antiblocage



	DÉSIGNATION	UT	CODE	PPHT (€)	ECOPART (€)
770.0196.30	MITIGEUR LAV.S/G 3000S+ROB.ARR. PRESTO 68132	U	4978A.8	245,38	0,01

Le PPHT comprend l'ecopart (€)

COLLECTIVITE POINT D'EAU

ROBINETTERIE COLLECTIVITE POINT D'EAU

PRESTO®

PRESTO 4000 S

Mitigeur lavabo temporisé - Avec bouton en laiton chromé



	DÉSIGNATION	UT	CODE	PPHT (€)	ECOPART (€)
770.0213.74	MITIGEUR LAV.4000S BOUTON CHR PRESTO 28610	U	64215.7	267,18	0,01

PRESTO®

PRESTO 7000

Mitigeur lavabo temporisé - Avec levier ergonomique omnidirectionnelle



	DÉSIGNATION	UT	CODE	PPHT (€)	ECOPART (€)
770.0203.17	MITIGEUR LAV.7000 S/G+ROB.ARR. PRESTO 68232	U	4690A.5	253,97	0,01

PRESTO®

PRESTO SAFE

Robinet temporisé sans contact sur plage mitigeur pour lavabo



	DÉSIGNATION	UT	CODE	PPHT (€)	ECOPART (€)
770.0209.92	MITIGEUR SAFE LAV TEMP S/P 3L/MN S/CONT 68077	U	2830H.4	262,41	0,01

PRESTO®

PRESTO SAFE

Robinet temporisé sans contact mural simple pour lavabo



	DÉSIGNATION	UT	CODE	PPHT (€)	ECOPART (€)
770.0170.50	ROBINET SAFE LAV/T MUR/SP S/CONT. 3L/MN 64675	U	28305.0	213,14	0,01

PRESTO®

PRESTO SAFE

Robinet temporisé sans contact sur plage simple pour lavabo



	DÉSIGNATION	UT	CODE	PPHT (€)	ECOPART (€)
770.0170.50	ROBINET SAFE LAV/T.S/CONT.S/PLAGE 3L/MN 64679	U	2830A.9	213,14	0,01

PRESTO®

SO'0

Mitigeur lavabo électronique sur plage - Alimentation par transformateur 230 Vac/7 Vdc boîtier IP65



	DÉSIGNATION	UT	CODE	PPHT (€)	ECOPART (€)
770.0348.28	MITIGEUR LAV.ELEC.SO'0+ROB.ARR. PRESTO 56210	U	1218C.0	435,37	0,02

Le PPHT comprend l'ecopart (€)

COLLECTIVITE POINT D'EAU

ROBINETTERIE COLLECTIVITE POINT D'EAU

PRESTO®

VOLTA

Mitigeur lavabo optoélectronique sur plage - Alimentation par pile Lithium 6V (type CPR2) intégrée



	DÉSIGNATION	UT	CODE	PPHT (€)	ECOPART (€)
770.0348.53	MITIGEUR LAV.ELEC.VOLTA+ROB.ARR. PRESTO 55160	U	1511D.2	435,67	0,01

PRESTO®

BEC

Sur table - Sur plage avec aérateur 6 l/mn et rosace - Arrivée mâle 1/2"



	DÉSIGNATION	UT	CODE	PPHT (€)	ECOPART (€)
770.0061.62	BEC FIXE LAVABO CHR RACC.12X14 PRESTO 30302	U	32225.5	77,03	0,01

PRESTO®

REGULATEUR THERMOSTATIQUE

Sécurité - blocage de température - Entrées parallèles 1/2" - Débit : 43 L à 3 bars



	DÉSIGNATION	UT	CODE	PPHT (€)	ECOPART (€)
770.0076.38	REGULATEUR TH.ENTREE PARALLE 1/2 PRESTO 29006	U	4859C.8	95,49	0,01

PRESTO®

REGULATEUR THERMOSTATIQUE

Sécurité - blocage de température - Entrées parallèles 3/4" - Débit : 47 L à 3 bars



	DÉSIGNATION	UT	CODE	PPHT (€)	ECOPART (€)
770.0076.38	REGULATEUR TH.ENTREE PARALLE 3/4 PRESTO 29007	U	4859E.3	95,49	0,01

ACCESSOIRES COLLECTIVITE POINT D'EAU



COLLECTIVITE

Distributeur de savon liquide - Anti-choc - Fermeture à clé



	DÉSIGNATION	UT	CODE	PPHT (€)	ECOPART (€)
756.0051.96	DISTRIBUTEUR SAV. PELLET 878160	U	63396.6	64,97	0,02

COLLECTIVITE POINT D'EAU

ACCESSOIRES COLLECTIVITE POINT D'EAU



COLLECTIVITE

Distributeur de savon liquide - Avec voyant de niveau et fermeture à clé



	DÉSIGNATION	UT	CODE	PPHT (€)	ECOPART (€)
756.0096.44	DISTRIBUTEUR SAV. PELLET 878155	U	70956.8	120,56	0,01



DISTRIBUTEUR DE SAVON LIQUIDE



	DÉSIGNATION	UT	CODE	PPHT (€)	ECOPART (€)
756.0121.44	DISTRIBUTEUR SAV.LIQUIDE ELECTR.PELLET 876122	U	1293P.4	151,85	0,05

Pour plus d'infos,
consultez
le CAHIER TECHNIQUE
page 14

J+0 100% Dispo



**SCANNEZ,
commandez,**

Téléchargez sur

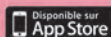

COLLECTIVITE DOUCHE

ROBINETTERIE COLLECTIVITE DOUCHE

DELABIE

PREMIX CONFORT

Mitigeur thermostatique - Mitigeur thermostatique centralisé d'eau mitigée de 32 à 42°C



	DÉSIGNATION	UT	CODE	PPHT (€)
771.0453.05	MITIGEUR PREMIX CONFORT 55 M3/4 DEL 731002	U	2238D.2	533,00
771.0702.23	MITIGEUR PREMIX CONFORT 90 M1 DEL 731003	U	22391.7	826,15
771.1008.02	MITIGEUR PREMIX CONFORT 140 M11/4 DEL 731004	U	2239F.6	1185,91

DELABIE

SPORTING 2

Colonne de douche temporisée



	DÉSIGNATION	UT	CODE	PPHT (€)
771.0132.40	PANNEAU DCH. SPORTING 2 DEL 714700	U	61830.6	155,77

DELABIE

MELANGEUR DOUCHE

Mélangeur de douche chromé avec têtes à clapet Long-Life



	DÉSIGNATION	UT	CODE	PPHT (€)
771.0065.97	MELANGEUR DCH. M1/2 80 DEL D2480	U	27646.9	77,61
771.0061.61	MELANGEUR DCH. M1/2 100 DEL D2481	U	23398.1	72,48
771.0063.77	MELANGEUR DCH. M1/2 110 DEL D2470	U	31905.3	75,02
771.0104.41	MELANGEUR BD M1/2 80 DEL D2408	U	32708.0	122,83

DELABIE

MITIGEUR UNIVERSEL

A cartouche céramique



	DÉSIGNATION	UT	CODE	PPHT (€)
771.0112.27	MITIGEUR DCH.60 A 80MM CHRDEL DEL 2308	U	80176.1	132,08
771.0133.38	MITIGEUR DCH.100 A 120MM CHR DEL 2312	U	80180.3	156,92

DELABIE

ACCESSOIRES ROBINETTERIE

Siphon de sol - Siphon de sol pour sol dur (carrelé ou béton brut), hauteur réglable



	DÉSIGNATION	UT	CODE	PPHT (€)
771.0039.16	SIPHON DE SOL 100X100 DEL 682001	U	28029.7	46,07
771.0073.13	SIPHON DE SOL 150X150 DEL 683001	U	28094.1	86,03

Le PPHT comprend l'ecopart (€)

COLLECTIVITE DOUCHE

ROBINETTERIE COLLECTIVITE DOUCHE

DELABIE

ACCESSOIRES ROBINETTERIE

Siphon de sol - Siphon de sol pour sol souple ou vinyle à hauteur réglable



	DÉSIGNATION	UT	CODE	PPHT (€)	
771.0051.51	SIPHON DE SOL D.115 AV.GRILLE DEL 683002	U	4690F.4	60,60	

PRESTO®

PRESTO 50

Robinet simple mural - Alimentation par le bas



	DÉSIGNATION	UT	CODE	PPHT (€)	ECOPART (€)
770.0073.18	ROBINET DCH.SPL.MUR.P50 ALIM.BAS PRESTO 38022	U	78029.6	91,48	0,01

PRESTO®

PRESTO 50

Robinet simple mural encastré



	DÉSIGNATION	UT	CODE	PPHT (€)	ECOPART (€)
770.0101.30	ROBINET DCH.SPLE A ENC.P50B CHR PRESTO 38222	U	25137.1	126,64	0,01

PRESTO®

DL 400 SE

Panneau de douche temporisé - Alimentation par le haut 1/2" - Robinet d'arrêt droit



	DÉSIGNATION	UT	CODE	PPHT (€)	ECOPART (€)
770.0159.19	PANNEAU DCH DL400SE+ROB.ARR.DRT PRESTO 27400	U	49667.9	199,00	0,01

thermador

MITIGEUR THERMOSTATIQUE

5217 - Avec sécurité anti-brûlures - Filtre et clapet intégrés - NF



	DÉSIGNATION	UT	CODE	PPHT (€)	ECOPART (€)
653.0104.30	MITIGEUR THERMOST.NICK.3/4" 30-50 NF MT521720	U	0790C.8	149,02	0,02

ACCESSOIRES COLLECTIVITE DOUCHE

PRESTO®

SECHE-MAINS

Automatique - Sur secteur



	DÉSIGNATION	UT	CODE	PPHT (€)	ECOPART (€)
770.0167.03	SECHE-MAINS AUTOMATIQUE PRESTO 70637	U	21007.0	208,88	0,09

Le PPHT comprend l'ecopart (€)

COLLECTIVITE BAIN

ROBINETTERIE COLLECTIVITE BAIN

DELABIE

MITIGEUR

Mitigeur bain-douche universel à cartouche céramique - Corps en laiton chromé M1/2"



	DÉSIGNATION	UT	CODE	PPHT (€)
771.0166.74	MITIGEUR BD 60 A 80MM CHR DEL 2508	U	80138.1	196,16
771.0188.96	MITIGEUR BD 100 A 120MM CHR DEL 2512	U	80143.1	222,30

DELABIE

RENOVATION 2000

Mélangeur bain-douche mural - Bec fixe à brise-jet - avec têtes à clapet Long-Life



	DÉSIGNATION	UT	CODE	PPHT (€)
771.0112.50	MELANGEUR BD M1/2 110 DEL D2410	U	31906.1	132,35

Pour plus d'infos,
consultez
le CAHIER TECHNIQUE
page 14

COLLECTIVITE ESPACE TOILETTES

WC SUSPENDU COLLECTIVITE

Vittra
CONFORMA

Pack WC suspendu PMR



	DÉSIGNATION	UT	CODE	PPHT (€)	ECOPART (€)
000.0290.40	PACK WC SUSP.PMR CONFORMA S/ BRI.5810B003-6078	U	215JX.7	363,21	0,21

WC AU SOL COLLECTIVITE

■ GEBERIT
PUBLICA

Cuvette sur pied surélevée - Sortie horizontale
- Alimentation indépendante



	DÉSIGNATION	UT	CODE	PPHT (€)	ECOPART (€)
702.0238.02	CUVETTE PUBLICA SURELEVEE BLC 00315500000	U	87477.6	297,65	0,12

Jacob Delafon
PARIS

EOLIA 4

Pack WC sur pied - Sortie horizontale



	DÉSIGNATION	UT	CODE	PPHT (€)	ECOPART (€)
704.0141.28	PACK WC S/P EOLIA 66,5X35,5 S/H BLC E0403-00	U	1032X.3	176,81	0,21

URINOIR, STALLE ET SIEGE A LA TURQUE

■ GEBERIT
SIPHON POUR URINOIR



	DÉSIGNATION	UT	CODE	PPHT (€)	ECOPART (€)
716.0019.33	SIPHON URIN.D50 HORIZ. GEBERIT 152950111	U	8334M.4	24,17	0,01

DELABIE
EQUIPEMENT POUR STALLE

Siphon d'urinoir - Siphon d'urinoir vertical ø 50 mm avec écrou ø32



	DÉSIGNATION	UT	CODE	PPHT (€)	ECOPART (€)
771.0030.46	SIPHON URINOIR ABS CHR M1 1/4 DEL 771000	U	73991.2	35,84	

COLLECTIVITE ESPACE TOILETTES

URINOIR, STALLE ET SIEGE A LA TURQUE

DELABIE
EQUIPEMENT POUR STALLE

Tubulure d'alimentation - A effet d'eau



	DÉSIGNATION	UT	CODE	PPHT (€)	ECOPART (€)
771.0036.58	TUBULURE F1/2 URINOIR DEL 751000	U	15779.2	43,04	

DELABIE
EQUIPEMENT POUR STALLE

Tubulure pour urinoir - Tubulure d'alimentation pour urinoir ordinaire ou siphonique



	DÉSIGNATION	UT	CODE	PPHT (€)	ECOPART (€)
771.0018.97	TUBULURE F1/2 URINOIR DEL 754000	U	73985.4	22,32	

Jacob Delafon
PARIS

COQUILLE 2

Urinoir nu 30x41.5 cm



	DÉSIGNATION	UT	CODE	PPHT (€)	ECOPART (€)
704.0030.24	EQUIPEMENT COMPLET COQUILLE 2 JD E74560-CP	U	04319.0	37,82	0,02

Jacob Delafon
PARIS

COQUILLE 2

Urinoir à effet d'eau - Alimentation et évacuation apparentes



	DÉSIGNATION	UT	CODE	PPHT (€)	ECOPART (€)
704.0067.64	URINOIR COQUILLE NU BLC JD E1519-00	U	22122.6	84,59	0,04

Jacob Delafon
PARIS

COQUILLE 2

Pack urinoir



	DÉSIGNATION	UT	CODE	PPHT (€)	ECOPART (€)
704.0191.52	PACK URINOIR COQUILLE 2 BLC JD E0399-00	U	6732F.9	239,44	0,04

Vittra
ARKITEKT

Séparateur pour urinoir



	DÉSIGNATION	UT	CODE	PPHT (€)	ECOPART (€)
000.0068.00	SÉPARATEUR URINOIR ARKITEKT 5172B003-0155	U	26600.5	85,02	0,02

Le PPHT comprend l'ecopart (€)

COLLECTIVITE ESPACE TOILETTES

ROBINETTERIE COLLECTIVITE ESPACE TOILETTES

DELABIE TEMPOCHASSE

Système de chasse d'eau sans réservoir - Par connexion directe à la canalisation



	DÉSIGNATION	UT	CODE	PPHT (€)
771.0219.38	KIT CUVETTE TEMPOCHASSE DEL 760004	U	54556.6	258,09

DELABIE TEMPOCHASSE

Système de chasse d'eau sans réservoir



	DÉSIGNATION	UT	CODE	PPHT (€)
771.0099.68	ROBINET CHASSE TEMPOCHASSE DEL 760000	U	12260.6	117,27

DELABIE TEMPOCHASSE

Robinet pour WC - Arrêt et réglage de débit équerre



	DÉSIGNATION	UT	CODE	PPHT (€)
771.0055.15	ROBINET ARRÊT ET RÉGLAGE EQ. DEL 765000	U	50738.4	64,88

DELABIE TEMPOSTOP

Robinet d'urinoir



	DÉSIGNATION	UT	CODE	PPHT (€)
771.0053.73	ROBINET URINOIR TEMPOSTOP MM1/2 DEL 777000	U	15778.4	63,21
771.0059.23	ROBINET URINOIR TEMPOSTOP MM1/2 DEL 778000	U	31981.4	69,68



NESS

Douchette hygiénique - Rond - Avec support mural fixe Mâle 1/2" à encastrer



	DÉSIGNATION	UT	CODE	PPHT (€)
768.0080.80	DOUCHETTE HYG.NESS+SUPP.ENC CHR PF 521CR03	U	5870E.5	101,00

PRESTO® KIT DE CHASSE

Pour cuvette normale - Kit n°1



	DÉSIGNATION	UT	CODE	PPHT (€)	ECOPART (€)
770.0180.20	KIT CHASSE N.1 AV.PRESTO ECLAIR PRESTO 13935	U	84850.7	225,26	0,01

COLLECTIVITE ESPACE TOILETTES

ROBINETTERIE COLLECTIVITE ESPACE TOILETTES

PRESTO® KIT DE CHASSE

Pour cuvette normale ou enfantine - Kit n°5



	DÉSIGNATION	UT	CODE	PPHT (€)	ECOPART (€)
770.0164.70	KIT CHASSE N.5 AV.PRESTO1000 PRESTO 14914	U	72434.4	205,88	0,01

PRESTO® PRESTO 12

Kit urinoir - Ensemble prêt à poser - Accessoires



	DÉSIGNATION	UT	CODE	PPHT (€)	ECOPART (€)
770.0024.54	TUBE EQUIPE URIN.ALLIA AUBAGNE PRESTO 50905	U	68525.5	30,67	
770.0017.04	TUBE EQUIPE URIN.JD COQUILLE PRESTO 50904	U	10824.1	21,30	

PRESTO® PRESTO 12

Robinet d'urinoir à action siphonique mural - Alimentation en ligne



	DÉSIGNATION	UT	CODE	PPHT (€)	ECOPART (€)
770.0049.90	ROBINET CHASSE URIN.P12 AV.1RACC.PRESTO 31001	U	62906.3	62,39	0,01

PRESTO® PRESTO 12A

Alimentation équerre - Arrivée 1/2" (15 x 21 mm)



	DÉSIGNATION	UT	CODE	PPHT (€)	ECOPART (€)
770.0055.43	ROBINET CHASSE URIN.P12A ALIM.EQ.PRESTO 31707	U	25947.3	69,30	0,01

PRESTO® PRESTO 1000

Robinet de chasse directe - En applique apparent



	DÉSIGNATION	UT	CODE	PPHT (€)	ECOPART (€)
770.0069.14	ROBINET CHASSE PRESTO1000 CHR PRESTO 14109	U	31096.1	86,43	0,01

PRESTO® PRESTO ECLAIR

Robinet de chasse temporisé en applique - Pour cuvettes WC, sièges à la turque et vidoirs



	DÉSIGNATION	UT	CODE	PPHT (€)	ECOPART (€)
770.0083.09	ROBINET CHASSE PRESTO ECLAIR CHR PRESTO 13001	U	30515.1	103,87	0,01

Le PPHT comprend l'ecopart (€)

COLLECTIVITE ESPACE TOILETTES

ROBINETTERIE COLLECTIVITE ESPACE TOILETTES

PRESTO®

RACCORD

Départ - Pour Presto Eclair - Eclair XL - Eyrem



	DÉSIGNATION	UT	CODE	PPHT (€)
770.0005.03	RACCORD DEPART ECR.11/4+JT D32 PRESTO 10400	U	30512.8	6,29

Pour plus d'infos,
consultez
le CAHIER TECHNIQUE
page 14

COLLECTIVITE CUISINE

EVIER, PLONGE ET TIMBRE OFFICE

■ GEBERIT

PUBLICA

À bandeau de 13 cm - Evier d'appoint -
A bords droits - Sans trop-plein



	DÉSIGNATION	UT	CODE	PPHT (€)
702.0138.58	EVIER A BORD DROIT 60X40CM BLC 00502000000	U	18608.0	173,23

■ GEBERIT

PUBLICA

1 cuve carrée à encastrer



	DÉSIGNATION	UT	CODE	PPHT (€)	ECOPART (€)
702.0242.17	EVIER DE LABO PUBLICA GEBERIT 500.920.00.1	U	25768.2	302,82	0,11

■ GEBERIT

PUBLICA

1 cuve - Timbre d'office - Avec trop-plein



	DÉSIGNATION	UT	CODE	PPHT (€)	ECOPART (€)
702.0294.66	TIMBRE OFFICE A/TP 60X50 361360000	U	254BJ.1	368,44	0,11

ROBINETTERIE COLLECTIVITE CUISINE

DELABIE

COMBINE DE PRELAVAGE



	DÉSIGNATION	UT	CODE	PPHT (€)
771.0592.58	ROBINETTERIE DCH.VAISS.GRDE CUISINE DEL G6632	U	42963.9	697,15

DELABIE

DOUCHETTE A GACHETTE



	DÉSIGNATION	UT	CODE	PPHT (€)
771.0093.40	DOUCHETTE GRDE CUISINE M1/2 BLC DEL 433000	U	75981.1	109,88

DELABIE

ACCESSOIRES ROBINETTERIE

Flexible cuisine



	DÉSIGNATION	UT	CODE	PPHT (€)
771.0059.34	FLEXIBLE ARME GRDE CUISINE 1.20M DEL 433120	U	42979.5	69,81

Le PPHT comprend l'ecopart (€)

COLLECTIVITE CUISINE

ROBINETTERIE COLLECTIVITE CUISINE

PRESTO
MELANGEUR 2 TROUS
BEC 160

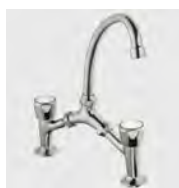

	DÉSIGNATION	UT	CODE	PPHT (€)	ECOPART (€)
770.0112.38	MELANGEUR 2 TROUS BEC 160 PRESTO 70763	U	0525R.2	140,48	0,01

PRESTO
PRESTO CHEF

Robinetterie Grande Cuisine - Colonne monotrou sur
plage avec douchette et bec de remplissage



	DÉSIGNATION	UT	CODE	PPHT (€)	ECOPART (€)
770.0499.93	MELANGEUR A/DCHETTE 2 JETS PRESTO CHEF 70820	U	294FZ.3	624,92	0,01

**VOTRE
ESPACE PRO,
LA CLÉ DE TOUS
VOS SUCCÈS !**

MON ESPACE PRO
www.richardson.fr



Rendez-vous vers
votre espace pro



ACCESSIBILITE POINT D'EAU

PLAN, LAVABO, LAVE-MAINS ACCESSIBILITE

Jacob Delafon
PARIS

ODEON UP
Lavabo - 1 trou percé



	DÉSIGNATION	UT	CODE	PPHT (€)	ECOPART (€)
704.0190.12	LAVABO ODEON UP 70X56,5 BLC JD E4495-00	U	1320F.8	237,71	0,06

Jacob Delafon
PARIS

STRUKTURA
Lavabo PMR



	DÉSIGNATION	UT	CODE	PPHT (€)	ECOPART (€)
704.0155.16	LAVABO PMR STRUKTURA NON MEULE 60 EGG111-00	U	175W3.7	194,01	0,06

Vitra

ARKITEKT
Lave-mains



	DÉSIGNATION	UT	CODE	PPHT (€)
000.0039.20	LAVE-MAINS ARKITEKT 39,5X26,5CM 6049L003-0294	U	2461N.0	49,00

Vitra

CONFORMA
Lavabo PMR - Percé 1 trou sans
trop-plein



	DÉSIGNATION	UT	CODE	PPHT (€)	ECOPART (€)
000.0145.60	LAVABO CONFORMA PMR 60X54 5289B003-0041	U	6860R.2	182,06	0,06

Vitra

CONFORMA
Lavabo PMR - Percé 1 trou



	DÉSIGNATION	UT	CODE	PPHT (€)	ECOPART (€)
000.0145.60	LAVABO S20 PMR 60X54 AV.T-PLEIN 5289B003-0001	U	4087Q.6	182,06	0,06

Pour plus d'infos,
consultez
le CAHIER TECHNIQUE
page 14

Le PPHT comprend l'ecopart (€)

Les tarifs et disponibilités de nos produits peuvent évoluer sans préavis

RICHARDSON

| 267 |

ACCESSIBILITE DOUCHE

ACCESSOIRES ACCESSIBILITE DOUCHE



AR SIS

Barre de douche - Barre d'appui



	DÉSIGNATION	UT	CODE	PPHT (€)	ECOPART (€)
756.0054.37	BARRE APPUI DRTE 40CM CHR/BLC PELLET 049940	U	1930S.7	67,97	0,01



AR SIS

Siège de douche escamotable



	DÉSIGNATION	UT	CODE	PPHT (€)	ECOPART (€)
756.0217.46	SIEGE DCH ARSIS ESCAM./DECLIP. BLC/GRI 047731	U	9453F.0	272,03	0,20



BARRE D'APPU I

Barre coudée - Angle 135°



	DÉSIGNATION	UT	CODE	PPHT (€)	ECOPART (€)
756.0078.09	BARRE APPUI COUD.135 40X40 BLC 3PTS 049270	U	6553J.8	97,62	0,01



SIEGE DE DOUCHE

Escamotable avec béquille automatique



	DÉSIGNATION	UT	CODE	PPHT (€)	ECOPART (€)
756.0138.07	SIEGE DCH 4 LAT/BEQUI. H50CM EPOX/BLC 047630	U	0836Z.6	172,79	0,20

Pour plus d'infos,
consultez
le CAHIER TECHNIQUE
page 14

ACCESSIBILITE ESPACE TOILETTES

WC SUSPENDU ACCESSIBILITE

GEBERIT

ACCESSOIRES

Tubulure d'alimentation pour cuvettes rallongées - Compatible avec les bâti-supports d'autres marques



	DÉSIGNATION	UT	CODE	PPHT (€)	ECOPART (€)
716.0018.48	TUBULURE ALIMENTATION NOIR 152170161	U	284L0.8	18,49	0,01

PACK WC SUR PIED ACCESSIBILITE



BRIVE

Pack WC surélevé - Hauteur - surélevée/PMR



	DÉSIGNATION	UT	CODE	PPHT (€)	ECOPART (€)
704.0252.04	PACK WC BRIVE S/P SURELEVE PMR BLC E22751-00	U	177MX.6	315,26	0,21

ACCESSOIRES ACCESSIBILITE ESPACE TOILETTES



CONFORT ET SECURITE

Barre d'appui - Barre ergonomique. Symétrique



	DÉSIGNATION	UT	CODE	PPHT (€)	ECOPART (€)
756.0051.18	BARRE APPUI COUD.135 40X40 BLC 2PTS 049230	U	73444.2	63,98	0,01
756.0092.80	BARRE APPUI COUD.135 40X40 CHR.2PTS 043533	U	9490A.6	116,01	0,01
756.0056.12	BARRE APPUI 30 PELLET 010203	U	9499A.7	70,16	0,01
756.0029.55	BARRE APPUI BLANC 30 PELLET 049130	U	43982.8	36,95	0,01
756.0062.84	BARRE APPUI 50 PELLET 010205	U	9347A.1	78,56	0,01
756.0041.44	BARRE APPUI 60 PELLET 049160	U	92184.1	51,81	0,01
756.0153.10	BARRE RELEVABLE BLC PELLET 048860	U	75060.4	191,41	0,03



CONFORT ET SECURITE

Béquille de soutien pour barre relevable



	DÉSIGNATION	UT	CODE	PPHT (€)	ECOPART (€)
756.0076.77	BEQUILLE DE SOUTIEN PELLET 048810	U	8920A.8	95,97	0,01

Le PPHT comprend l'ecopart (€)

ACCESSIBILITE ESPACE TOILETTES

ACCESSOIRES ACCESSIBILITE ESPACE TOILETTES

PRESTO

BARRE D'APPUI

Coudée à 135°, Diamètre 32 mm



	DÉSIGNATION	UT	CODE	PPHT (€)	ECOPART (€)
770.0066.67	BARRE COUDEE 135 40X40CM D32INOX PRESTO 60324	U	5667E.2	83,35	0,01

Pour plus d'infos,
consultez
le CAHIER TECHNIQUE
page 14

J+0 100% DISPO



**L'atout
LIBRE-SERVICE**

- Un large choix de produits
- Tous les produits de ce catalogue à votre disposition
- Une équipe à votre service

Le PPHT comprend l'ecopart (€)

PIECES DE RECHANGE SANITAIRE

BAIGNOIRE

ANQUIER

KIT FIXATION BAIGNOIRE



	DÉSIGNATION	UT	CODE	PPHT (€)
276.0029.99	KIT FIXATION BAIGN. SIMPLY FIX ANQUIER 1820	U	7477D.1	39,99

ROBINETTERIE

DELABIE

AERATEUR

Anti-tartre - Aérateur antitartre sans économiseur - F22/100 - Livré par 5 pièces



	DÉSIGNATION	UT	CODE	PPHT (€)
771.0026.30	AERATEUR SEUL F 22X1 X5 DEL 22.5P	U	57362.6	30,94

DELABIE

AERATEUR

Anti-tartre - Aérateur antitartre sans économiseur - M24/100 - M28/100 - Livré par 5 pièces



	DÉSIGNATION	UT	CODE	PPHT (€)
771.0026.30	AERATEUR SEUL M 24X100 X5 DEL 24.5P	U	57368.3	30,94

DELABIE

AERATEUR

Anti-tartre - Aérateur antitartre économiseur - Avec joint bleu - M24/100 - Livré par 2 pièces



	DÉSIGNATION	UT	CODE	PPHT (€)
771.0011.58	AERATEUR ECONOMISEUR M 24X1 DEL 925624.2P	U	62892.5	13,62

DELABIE

BEC UNIVERSEL

Col de cygne - Brise-jet antitartre à 3 l/min - Avec aérateur



	DÉSIGNATION	UT	CODE	PPHT (€)
771.0023.48	BEC LAVABO+AERATEUR F1/2 L150 DEL 960152	U	10955.3	27,62
771.0032.95	BEC EVIER+AERATEUR F3/4 L250 DEL 965252	U	38548.4	38,77

PIECES DE RECHANGE SANITAIRE

ROBINETTERIE

DELABIE

BEC UNIVERSEL

Horizontal mural - Brise-jet réglable à 3 l/min - Avec aérateur



	DÉSIGNATION	UT	CODE	PPHT (€)
771.0020.00	BEC HORIZ.+AERATEUR F1/2 L120 DEL 940122	U	38524.5	23,53
771.0021.13	BEC HORIZ.+AERATEUR F1/2 L150 DEL 940152	U	10950.4	24,86
771.0022.23	BEC HORIZ.+AERATEUR F1/2 L200 DEL 940202	U	38525.2	26,15
771.0025.86	BEC HORIZ.+AERATEUR F1/2 L250 DEL 940252	U	26507.4	30,42
771.0025.80	BEC HORIZ.+AERATEUR F3/4 L150 DEL 945152	U	10953.8	30,35

DELABIE

RACCORD

Applique Mâle-Femelle - Avec écrou CB



	DÉSIGNATION	UT	CODE	PPHT (€)
771.0044.46	RACCORD APPLIQUE MF1/2 DEL 841015.2P	U	39096.3	52,30

DELABIE

RACCORD

Applique Mâle-Mâle - Avec écrou CB ø 14



	DÉSIGNATION	UT	CODE	PPHT (€)
771.0036.21	RACCORD APPLIQUE M1/2 M3/4 DEL 841027.2P	U	43818.4	42,60

DELABIE

RACCORD

Raccord excentré 5 mm - Mâle - Femelle



	DÉSIGNATION	UT	CODE	PPHT (€)
771.0019.82	RACCORD EXCENTRE 5MM MF1/2 DEL 851015.2P	U	43605.5	23,32

DELABIE

RACCORD

Colonnette - A embase fondue H 70 - Mâle - Mâle



	DÉSIGNATION	UT	CODE	PPHT (€)
771.0066.70	RACCORD COLONNETTE M1/2M3/4 DEL 866027.2P	U	45345.6	78,47

DELABIE

RACCORD

Equerre - Mâle - Femelle



	DÉSIGNATION	UT	CODE	PPHT (€)
771.0037.82	RACCORD EQUERRE MF1/2 DEL 871015.2P	U	53240.8	44,49

PIECES DE RECHANGE SANITAIRE

ROBINETTERIE

DELABIE

RACCORD

Mural décalé - De 21 mm - Pour robinetteries d'entraxe 110 à 190 mm. - Universel - Mâle - Mâle



	DÉSIGNATION	UT	CODE	PPHT (€)
771.0045.18	RACCORD DECALE 21MM M3/8M3/4 DEL 857018.2P	U	53774.6	53,15
771.0045.78	RACCORD DECALE 21MM M1/2M3/4 DEL 857027.2P	U	53791.0	53,86

DELABIE

RACCORD

Mural décalé - de 45 mm - Pour robinetteries d'entraxe 60 à 240 mm - Mâle - Mâle



	DÉSIGNATION	UT	CODE	PPHT (€)
771.0072.66	RACCORD DECALE 45MM M1/2M3/4 DEL 858027.2P	U	18200.6	85,48

DELABIE

RACCORD

Mural décalé - standard - Mâle - Mâle



	DÉSIGNATION	UT	CODE	PPHT (€)
771.0015.33	RACCORD DECALE M1/2M3/4 DEL 856127.2P	U	14119.2	18,03
771.0027.37	RACCORD DECALE M1/2M3/4 DEL 856027.2P	U	39081.5	32,20

DELABIE

RACCORD

Fou à écrou tournant - Femelle - Femelle



	DÉSIGNATION	UT	CODE	PPHT (€)
771.0018.65	RACCORD FOU F1/2 F1/2 DEL 820015.2P	U	43608.9	21,94



ACCESSOIRES COMMUNS

Élément thermostatique à cire - Pour modèle: Taron/Chiara/Sentosa/Eurotrend/Grohtherm/Automatic



	DÉSIGNATION	UT	CODE	PPHT (€)	ECOPART (€)
762.0101.36	ELEMENT CIRE 1/2 GROHE 47450000	U	23319.7	112,64	0,02

Le PPHT comprend l'ecopart (€)

PIECES DE RECHANGE SANITAIRE

ROBINETTERIE



CARTOUCHE ROBINETTERIE DOUCHE A ENCASTRER

Commande Aquadimmer - GRT 3000



	DÉSIGNATION	UT	CODE	PPHT (€)	ECOPART(€)
762.0092.72	TETE AQUADIMMER GRT3000 GROHE 47364000	U	85304.4	103,04	0,02



CARTOUCHE ROBINETTERIE

Céramique - A disque



	DÉSIGNATION	UT	CODE	PPHT (€)	ECOPART(€)
762.0050.18	CARTOUCHE A DISQUE D.46MM GROHE 46048000	U	31600.0	55,78	0,02



CARTOUCHE ROBINETTERIE

Tête céramique - Carbodur



	DÉSIGNATION	UT	CODE	PPHT (€)	ECOPART(€)
762.0032.91	TETE CARBODUR 1/2 GROHE 45346000	U	90098.5	36,59	0,02



VIDAGE

Pour lavabo et bidet



	DÉSIGNATION	UT	CODE	PPHT (€)	ECOPART(€)
762.0016.32	CLAPET VIDAGE GROHE 07182000	U	31918.6	18,15	0,02



TETE

A clapet



	DÉSIGNATION	UT	CODE	PPHT (€)	ECOPART(€)
762.0011.30	TETE CLAPET 1/2 GROHE 07146000	U	44251.7	12,58	0,02

Le PPHT comprend l'ecopart (€)

PIECES DE RECHANGE SANITAIRE

ROBINETTERIE



CARTOUCHE



	DÉSIGNATION	UT	CODE	PPHT (€)	ECOPART(€)
768.0081.98	CARTOUCHE THERMOSTATIQUE PF 2959	U	21890.9	82,00	0,02
768.0054.99	CARTOUCHE INV.ROB/ARRET P/MIT.MUR 53956DDEV35	U	239V9.9	55,00	0,01

TOILETTES / WC



ACCESSOIRES

Garniture de raccordement - Pour WC suspendu



	DÉSIGNATION	UT	CODE	PPHT (€)	ECOPART(€)
762.0043.09	TUBE DE LIAISON GROHE 37311K00	U	89719.9	47,90	0,02

100% EXPO



Faites de nos salles Expo
vos outils de vente

UltraCare®

PRENEZ SOIN DE VOS SURFACES

PRODUITS POUR
LE NETTOYAGE

PRODUITS POUR
LA PROTECTION

PRODUITS
COMPLÉMENTAIRES

UNE GAMME COMPLÈTE DE PRODUITS
DE NETTOYAGE ET D'ENTRETIEN
POUR LA PROTECTION DES SURFACES



Compatible carreaux de céramique,
pierre naturelle, mosaïque, sols en résine...

DÉCOUVREZ
LA GAMME



Carrelage

SOMMAIRE

PREPARATION DE SUPPORT

PRIMAIRE 274

COLLE ET JOINTS

COLLE EN POUDRE..... 274

COLLE EN PATE 274

JOINTS 275

JOINTS EPOXY 275

PROFILES ET PRODUITS DE FINITION

PROFILE 275

ENTRETIEN ET PROTECTION

ENTRETIEN 276

PREPARATION DE SUPPORT

PRIMAIRE



ECO PRIM UNIVERSEL

Primaire d'adhérence monocomposant, sans solvant, tous supports



	DÉSIGNATION	UT	CODE	PPHT (€)
532.0049.50	PRIMAIRE ECO PRIM/UNIV. FUT-5KG 1558805	U	222YT.3	70,72

Pour plus d'infos,
consultez
le CAHIER TECHNIQUE
page 14

greensolutions
Votre partenaire énergie
en partenariat avec **dropo**

Hotline **06 27 52 64 95**

www.richardson.fr/services/green-solutions

COLLE ET JOINTS

COLLE EN POUDRE



KERAFLEX EXTRA S

Mortier colle amélioré et déformable C2S1 TE/ C2S1 EG, à consistance variable (normale ou fluide), destiné à la pose de carrelage en sol et mur int/ext



	DÉSIGNATION	UT	CODE	PPHT (€)
532.0019.57	MORTIER COLLE KERAFLEX EXT. S 25KG BL 1193425	U	373KH.3	27,96
532.0018.31	MORTIER COLLE KERAFLEX EXTR/S 25KG GR 1193325	U	373KF.7	26,16



KERAFIX EXTRA

Mortier colle amélioré C2TE destiné à la pose de carrelage en sol et mur intérieurs et sol extérieur



	DÉSIGNATION	UT	CODE	PPHT (€)
532.0016.09	MORTIER COLLE KERAFIX EXTRA 25KG BLC 1197225	U	373K4.2	22,98
532.0014.45	MORTIER COLLE KERAFIX EXTRA GRIS 25KG 1197125	U	373K3.4	20,64



ULTRAPLAN

Mortier colle maxi fibré



	DÉSIGNATION	UT	CODE	PPHT (€)
532.0025.07	RAGREAGE ULTRAPLAN MAX/FIB. 25KG 1490025	U	9347T.5	35,82

COLLE EN PATE



KERALASTIC

Colle polyuréthane bi-composant pour la pose du carrelage et de la pierre



	DÉSIGNATION	UT	CODE	PPHT (€)
532.0061.56	COLLE KERALASTIC T GRIS KIT 5KG 103605	U	9560Y.4	87,94

COLLE ET JOINTS

JOINTS



Vous faciliter la vie

CONCRÈTES - LIÉGÈRES

ULTRACOLOR PLUS

Mortier à séchage rapide hydrofugé et anti-moisissure
- Murs, sols, intérieurs et extérieurs



	DÉSIGNATION	UT	CODE	PPHT (€)
532.0018.40	JOINT ULTRACOLOR+ 100 5KG BLANC 6010005AFR	U	344VW.1	26,28
532.0020.64	JOINT ULTRACOLOR+ 111 5KG GRIS AR 6011105AFR	U	344W3.9	29,48
532.0024.02	JOINT ULTRACOLOR+ 132 BEIGE 5KG 6013205AFR	U	347CT.4	34,32
532.0024.02	JOINT ULTRACOLOR+ 120 NOIR 5KG 6012005AFR	U	347D5.0	34,32
532.0024.02	JOINT ULTRACOLOR+ 5KG 103 BLC LUNE 6010305AFR	U	359TQ.4	34,32
532.0024.02	JOINT ULTRACOLOR+ 5KG 110 MANHATT. 6011005AFR	U	359TS.0	34,32
532.0024.02	JOINT ULTRACOLOR+ 112 GRIS M. 5KG 6011205AFR	U	347BR.9	34,32
532.0017.28	JOINT ULTRACOLOR+ 113 5KG GR/CIM. 6011305AFR	U	352ZG.0	24,68
532.0024.02	JOINT ULTRACOLOR+ 114 5KG ANTH. 6011405AFR	U	352ZC.9	34,32
532.0024.02	JOINT ULTRACOLOR N119 GRIS LON.5KG 6011905AFR	U	3573Z.1	34,32
532.0024.29	JOINT ULTRACOLOR+ N123 BLC/ANTI 5KG 60012305A	U	359K6.6	34,70
532.0024.02	JOINT ULTRACOLOR+ 133 SABLE 5KG 6013305AFR	U	357Q1.1	34,32
532.0024.02	JOINT ULTRACOLOR+ 5KG 134 SOIE 6013405AFR	U	359U9.6	34,32
532.0024.02	JOINT ULTRACOLOR+ 5KG 135 POUSS/OR 6013505AFR	U	359UA.3	34,32
532.0024.02	JOINT ULTRACOLOR+ 5KG 137 CARAIBES 6013705AFR	U	359UC.9	34,32
532.0024.02	JOINT ULTRACOLOR PLUS 143 5KG 6014305AFR	U	340VC.8	34,32
532.0024.02	JOINT ULTRACOLOR+ 5KG 149 PIER/VOL 6014905AFR	U	359UJ.5	34,32
532.0024.29	JOINT ULTRACOLOR+ N187 LIN 5KG 60018705A	U	359KJ.9	34,70
532.0024.29	JOINT ULTRACOLOR+ N188 BISCUIT 5KG 60018805A	U	359KK.7	34,70

JOINTS EPOXY



Vous faciliter la vie

CONCRÈTES - LIÉGÈRES

KERAPOXY EASY DESIGN

Colle et joint décoratif - Mortier époxy bicomposant décoratif, antiacide et antimoisissures



	DÉSIGNATION	UT	CODE	PPHT (€)
532.0045.45	JOINT KERAPOXY EASY DESIGN 100 3KG 5KB010003	U	353GD.8	69,92
532.0045.45	JOINT KERAPOXY EASY DESIGN 110 3KG 5KB011003	U	374DB.1	69,92
532.0045.45	JOINT KERAPOXY EASY DESIGN 132 3KG 5KB013203	U	394JJ.7	69,92

Pour plus d'infos,
consultez
le CAHIER TECHNIQUE
page 14

Le PPHT comprend l'ecopart (€)

PROFILES ET PRODUITS DE FINITION

PROFILE

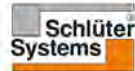

SCHLUTER-JOLLY-ACG

Profilé de protection et de décoration des arrêtes de revêtements carrelés - Longueur 2m50



	DÉSIGNATION	UT	CODE	PPHT (€)	ECOPART (€)
025.0017.58	PROFILE SCHIENE-AC 2.5M BLC MAT 11MM A110MBW	U	241UV.2	21,98	0,01
025.0017.58	PROFILE SCHIENE-AC 2.5M NOIR MAT 11MM A110MGS	U	241V4.6	21,98	0,01

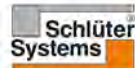

SCHLUTER-QUADEC-AE

Profilé de finition pour angles - Longueur 2m50



	DÉSIGNATION	UT	CODE	PPHT (€)	ECOPART (€)
025.0016.41	PROFILE QUADEC-AE 2,5M ALU/MAT Q100AE	U	3892N.7	20,52	0,01



SCHLUTER-SCHIENE-AE

Profilé de protection et de décoration des arrêtes de revêtements carrelés - Longueur 2m50



	DÉSIGNATION	UT	CODE	PPHT (€)	ECOPART (€)
025.0011.84	PROFILE EQUER. ALU 8MM SCHIENE-AE 2.5M AE80	U	0068B.5	14,81	0,01
025.0012.62	PROFILE EQUER. ALU 10MM SCHIENE-AE 2.5M AE100	U	0069B.4	15,79	0,01
025.0013.44	PROFILE EQUER. ALU 11MM SCHIENE-AE 2.5M AE110	U	5447V.7	16,81	0,01

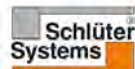

SCHLUTER - TREP-FL

Profilé décoratif pour nez de marches - Longueur 2,50 m



	DÉSIGNATION	UT	CODE	PPHT (€)
025.0031.42	PROFILE TREP-FL-AE L2,5M ALU MAT.11MM FL110AE	U	5475W.0	39,27

ENTRETIEN ET PROTECTION

ENTRETIEN

LITOKOL
HI PERFORMANCE SEALING PRODUCTS

SCOTCH BRITE

109/G - Feutre interchangeable pour
taloche de nettoyage



	DÉSIGNATION	UT	CODE	PPHT (€)
025.0002.85	SCOTCH BRITE POUR STARLIKE 109GBNC	U	2694H.0	3,80

Pour plus d'infos,
consultez
le CAHIER TECHNIQUE
page 14

100% CARRELAGE

L'indissociable de la Salle de Bains !

PRENEZ RENDEZ-VOUS DANS NOS SALLES D'EXPO : TOUTES NOS SOLUTIONS DE CARRELAGE POUR VOUS OU VOS CLIENTS PARTICULIERS !

- Grès cérame, faïences, mosaïques, pierres...
- Sol / mur
- Intérieur / extérieur
- Décors, listes, plinthes...
- Sols modulaires (Luxury vinyl tiles)



Colles, joints, croisillons, profilés, produits nettoyants et protecteurs, panneaux à carreler, siphons de sol, outillage... sont disponibles dans le Catalogue Pro et le Libre-service.

Découvrez notre gamme exclusive de carrelage dans notre catalogue Collections Exclusives

Et toujours nos 60 pages de carrelage dans le catalogue Salle de Bains et Carrelage !
À proposer à vos clients



Ce picto vous indique les agences proposant l'activité carrelage à la fin du catalogue.

2024

GAMME KIT'O

Kit complet pour récupération des eaux de pluie



- 4 kits selon vos usages : arrosage, alimentation WC et machine à laver
- Économie d'eau potable
- Pratique et facile à utiliser
- Système automatisé
- Installation facile

E.SYBOX MINI

Surpresseur domestique à vitesse variable

- Compact et silencieux : **45dB**
- Consomme jusqu'à **50% d'énergie en moins** qu'un surpresseur traditionnel
- Installation rapide
- Garantit une pression constante



P1 MAX
850W
Q MAX
4,8 m³/h
H MAX
5,5 bar
ASPIRATION MAX
8m

Eau - Piscine

SOMMAIRE

POMPAGE

SURPRESSEUR DE SURFACE.....	280
POMPE DE RELEVAGE.....	280
RESERVOIR, BALLON ET CUVE.....	281
ACCESSOIRES POUR POMPE.....	281

TRAITEMENT DES EAUX

ADOUCCISSEUR.....	282
FILTRE.....	282
ANTITARTRE.....	282
STERILISATEUR UVC.....	283

ARROSAGE

ARROSAGE MANUEL ET DE SURFACE.....	283
ARROSAGE ENTERRE.....	283

PISCINE

FILTRATION DE PISCINE.....	284
PIECES A SCELLER POUR PISCINE.....	284
NETTOYAGE ET ENTRETIEN DE PISCINE.....	284
TRAITEMENT DE L'EAU POUR PISCINE.....	285
ACCESSOIRES POUR PISCINE.....	286

POMPAGE

SURPRESSEUR DE SURFACE



SURPRESSEUR

AQUAJET groupe monophasé - 1 pompe - RED



	DÉSIGNATION	UT	CODE	PPHT (€)	ECOPART (€)
460.0705.50	GROUPE AQUAJET RED.MONTE 102/60 MONO 201025	U	57533.2	834,15	4,15



SURPRESSEUR

JET - Pompe auto-amorçante - Monocellulaire - de 0,6 à 10 m³/h avec HMT jusqu'à 60 m de C.E.



	DÉSIGNATION	UT	CODE	PPHT (€)	ECOPART (€)
460.0254.15	POMPE AMORCAGE AUTOMAT.JET 102M 016100	U	57514.2	299,88	0,88



SURPRESSEUR

E.SYBOX - Pour une pression d'eau constante dans l'installation



	DÉSIGNATION	UT	CODE	PPHT (€)	ECOPART (€)
460.0842.25	SURPRESSEUR PRESS.CONST.MINI E.SYBOX 209501	U	8070X.1	1123,88	0,88

POMPE DE RELEVAGE



POMPE EAUX CLAIRES

DR STEEL - Monophasée - Automatique - Livrée avec flotteur et prise normalisée



	DÉSIGNATION	UT	CODE	PPHT (€)	ECOPART (€)
460.0426.70	POMPE RELEVAGE DR-STEEL 37 MONO AUTO 137610	U	0686M.5	502,88	0,88



POMPE EAUX CLAIRES

NOVA 180/200/300/600 R - NOVA 300



	DÉSIGNATION	UT	CODE	PPHT (€)	ECOPART (€)
460.0248.20	POMPE RELEVAGE NOVA 300R AUT.MONO 131157	U	262DA.0	292,35	0,35

POMPAGE

POMPE DE RELEVAGE



POMPE EAUX CLAIRES ET USEES

VERTY NOVA - 200 - Granulométrie : 5 mm



	DÉSIGNATION	UT	CODE	PPHT (€)	ECOPART (€)
460.0253.30	POMPE RELEVAGE VERTY NOVA 200 131003	U	4698L.5	298,35	0,35



POMPE EAUX CHARGÉES

SEMISOM - Série 265



	DÉSIGNATION	UT	CODE	PPHT (€)	ECOPART (€)
460.0592.45	POMPE RELEV.SEMISOM 265 AUTO MONO 132038	U	60735.8	697,88	0,88



POMPE EAUX CHARGÉES

SEMISOM - Série 290



	DÉSIGNATION	UT	CODE	PPHT (€)	ECOPART (€)
460.0705.00	POMPE RELEV.SEMISOM 290 AUT.-HORIZ.M 136039	U	9795H.3	705,88	0,88



POMPE EAUX USEES

FEKA 600 - Avec commande automatique par flotteur - Mono



	DÉSIGNATION	UT	CODE	PPHT (€)	ECOPART (€)
460.0362.10	POMPE RELEVAGE FEKA 600R MONO AUTO 131172	U	262E6.8	426,88	0,88



Agitateur d'eau

POMPE SERPILLERE

SANIPUDDLE - Pour eaux claires de bassin



	DÉSIGNATION	UT	CODE	PPHT (€)	ECOPART (€)
717.0195.65	POMPE SERPILL.SANIPUDDLE FSP SANIPUDDLE-001	U	251A4.0	279,92	0,42



Agitateur d'eau

STATION EAUX CHARGÉES

SANICUBIC 1 - Eaux grises et eaux noires (avec WC)



	DÉSIGNATION	UT	CODE	PPHT (€)	ECOPART (€)
717.1363.25	STATION RELEV.SANICUBIC 1 SFA CUBIC1NM	U	6118M.0	1947,75	0,25

Le PPHT comprend l'ecopart (€)

POMPAGE

RESERVOIR, BALLON ET CUVE

 LE RESERVOIR MASSAL

RESERVOIR A PRESSION

HYDROPAN - Réservoir eau froide - Avec vessie - Vertical - 10 Bar



	DÉSIGNATION	UT	CODE	PPHT (€)	
460.0288.28	RESERVOIR HYDROPAN A VESSIE 10B -100L-53110	U	4381L.7	384,38	
460.0529.77	RESERVOIR HYDROPAN A VESSIE 10B -200L- 53120	U	43821.8	706,36	
460.0666.43	RESERVOIR HYDROPAN A VESSIE 10B -300L- 53130	U	4382B.6	888,57	
460.0880.77	RESERVOIR HYDROPAN A VESSIE 10B -500L-53150	U	4382C.4	1174,36	

ACCESSOIRES POUR POMPE



ACCESSOIRE ELECTRIQUE

TM-RED - Interrupteur de Niveau - Avec câble Néoprène



	DÉSIGNATION	UT	CODE	PPHT (€)	ECOPART (€)
460.0036.55	CONTACTEUR 3 FILS TM-RED 5M 411525	U	74359.1	43,13	0,13



ACCESSOIRE ELECTRIQUE

Contacteur Manométrique - XMP 6 et 12 PM bi/tripolaire



	DÉSIGNATION	UT	CODE	PPHT (€)	ECOPART (€)
460.0045.05	CONTACTEUR MANO.XMP6 TRIPOL. 412506	U	76089.2	53,15	0,15
460.0045.05	CONTACTEUR MANO.XMP12 TRIPOL. 412512	U	56198.5	53,15	0,15



ACCESSOIRE HYDRAULIQUE

Clapet à boule PVC "CH-RU" - Tarudés Femelle/Femelle



	DÉSIGNATION	UT	CODE	PPHT (€)	ECOPART (€)
000.0051.00	CLAPET PVC A BOULE CH-RU FF 1"1/4 610015	U	51231.9	75,01	0,01
000.0068.00	CLAPET PVC A BOULE CH-RU FF 1"1/2 610016	U	82321.4	100,02	0,02
264.0138.00	CLAPET ANTI-RET.BOULE CH-RU FF 2" 610017	U	7748H.5	138,02	0,02



ACCESSOIRE HYDRAULIQUE

Kit d'aspiration - Dom



	DÉSIGNATION	UT	CODE	PPHT (€)	ECOPART (€)
460.0046.75	KIT ASPIRATION 7M D.22 454227	U	79387.7	55,01	0,01

Le PPHT comprend l'ecopart (€)

POMPAGE

ACCESSOIRES POUR POMPE



ACCESSOIRE HYDRAULIQUE

Tuyau - Type "Spirale"



	DÉSIGNATION	UT	CODE	PPHT (€)	ECOPART (€)
460.0162.40	TUYAU SPIRALE 40MM 25M 454740	U	2384U.1	203,34	0,34

Pour plus d'infos,
consultez
le CAHIER TECHNIQUE
page 14

J+0 100% Dispo



**SCANNEZ,
commandez,**

Téléchargez sur

Disponible sur
App Store

DISPONIBLE SUR
Google play

TRAITEMENT DES EAUX

ADOUCCISSEUR



SEL POUR ADOUCISSEUR
AQUA CLASSIC - Pastille 12/24



	DÉSIGNATION	UT	CODE	PPHT (€)
050.0010.54	SEL ADOUC.PAST.12/24 AQUA CLASSIC 15KG 116655	U	277DB.6	13,51

FILTRE



FILTRE A CARTOUCHE
BWT AQA Pura - Filtre sous évier



	DÉSIGNATION	UT	CODE	PPHT (€)
000.0116.00	FILTRE SOUS EVIER CHARBON AQAPURA 125305842	U	3518P.9	145,00



ACCESSOIRES POUR FILTRES
Cartouche



	DÉSIGNATION	UT	CODE	PPHT (€)
000.0060.00	CARTOUCHE RECHARGE AQAPURA 125305843	U	3518Q.7	75,00



ACCESSOIRES POUR FILTRES
Cartouches et consommables - Polypropylène



	DÉSIGNATION	UT	CODE	PPHT (€)
901.0003.00	CARTOUCHE ANTI-IMPURETES 25UM 125550137	U	370EP.2	4,00
901.0004.00	CARTOUCHE BWT ANTI-IMPURETES 5UM 125550138	U	383DG.1	4,00



FILTRE A CARTOUCHE
Filtre sénior (sans cartouche)- 3 pièces - Single



	DÉSIGNATION	UT	CODE	PPHT (€)	ECOPART (€)
000.0027.30	FILTRE SENIOR SINGLE+ 3P-AFO-SX-TS 3/4 491120	U	48406.3	39,02	0,02

TRAITEMENT DES EAUX

FILTRE



FILTRE A CARTOUCHE
SX - Avec montage standard - BIPLEX - Montage sur arrivée d'eau froide exclusivement



	DÉSIGNATION	UT	CODE	PPHT (€)	ECOPART (€)
000.0084.00	STATION BIPLEX SX 3/4" COMPLETE 491161	U	04276.2	120,07	0,07



FILTRE AUTONET
FILTRE SEMI AUTOMATIQUE - 120 T



	DÉSIGNATION	UT	CODE	PPHT (€)
000.0126.17	FILTRE AUTONETTOYANT 120T 3/4" 01410002	U	387UU.5	180,24



CARTOUCHE
Plastique lavable - Antiboue



	DÉSIGNATION	UT	CODE	PPHT (€)
000.0012.84	CARTOUCHE PLAST.LAV.9RL60 60M 03030002	U	08226.3	25,68



CARTOUCHE
Antigoûts - Antiodeurs



	DÉSIGNATION	UT	CODE	PPHT (€)
000.0018.75	CARTOUCHE BOBINÉE 9 CAPA + CHARBON 03020000	U	23157.1	28,84

ANTITARTRE



ANTITARTRE DOMESTIQUE
Station résidentielle - Installation sur eau froide - PD15C - 10 bar - Temp: 5 - 85 °C



	DÉSIGNATION	UT	CODE	PPHT (€)	ECOPART (€)
905.0639.20	ANTITARTRE MAGN.AIMANT CERA.3/4 33L/MIN PD15C	U	91974.6	799,02	0,02
905.0783.20	ANTITARTRE MAGN.DOMESTIQUE 3/4 33L/M PD15CPRO	U	00683.3	979,02	0,02

Le PPHT comprend l'ecopart (€)

TRAITEMENT DES EAUX

STERILISATEUR UVC

BWT
BEST WATER TECHNOLOGY
LAMPE UV
Biostil UV



	DÉSIGNATION	UT	CODE	PPHT (€)
901.0124.30	LAMPE DE RECHANGE 37W GENER.UV 1 800 P0015622	U	8993D.4	124,30

Pour plus d'infos,
consultez
le CAHIER TECHNIQUE
page 14

ARROSAGE

ARROSAGE MANUEL ET DE SURFACE

France Arrosage
L'eau. Notre culture.

NEZ DE ROBINET
Dérivation deux voies - Modèle "Y"



	DÉSIGNATION	UT	CODE	PPHT (€)
000.0022.28	DERIVATION Y 3/4" FMM 2 VOIES 81RAA27Y00C	U	4914A.5	27,85

ARROSAGE ENTERRE

France Arrosage
L'eau. Notre culture.

ACCESSOIRE
Allonge ajustable



	DÉSIGNATION	UT	CODE	PPHT (€)
000.0001.33	ALLONGE AJUSTABLE 1/2-1/2 81AA212100C	U	63542.5	1,66

**VOTRE
ESPACE PRO,
LA CLÉ DE TOUS
VOS SUCCÈS !**



MON ESPACE PRO
www.richardson.fr



Rendez-vous vers
votre espace pro



PISCINE

FILTRATION DE PISCINE



COFFRET DE FILTRATION

Avec transfo 100 W



	DÉSIGNATION	UT	CODE	PPHT (€)
902.0176.25	COFFRET FILTR.+TRANSE.100W+DISJ. 74320	U	3072E.8	235,00



FILTRE A SABLE

Vesubio - Avec vanne multi-voies latérale



	DÉSIGNATION	UT	CODE	PPHT (€)
902.0423.00	FILTRE VESUBIO D600 VERT 1"1/2 047087V 19776V	U	4733E.5	564,00



FLOCCULANT

Cartouche - 8 x 125g



	DÉSIGNATION	UT	CODE	PPHT (€)
903.0007.96	FLOCCULANT -CART.1KG- A04301	U	284XQ.0	9,95



ACCESSOIRE

Consommables - Charge filtrante - Sac de 25 Kg



	DÉSIGNATION	UT	CODE	PPHT (€)
903.0025.60	VERRE ECO FILTRANT 1.6-3MM -25KG- 049399BPA	U	8908X.9	25,60
903.0025.60	VERRE ECO FILTRANT 0.4-1,6MM -25KG- 049395BPA	U	270QP.8	25,60

PIECES A SCELLER POUR PISCINE



SKIMMER

ABS - Standard - 15 litres



	DÉSIGNATION	UT	CODE	PPHT (€)
902.0076.64	SKIMMER BETON 15L CARRE GM 042629 00252	U	265RT.9	95,80



SKIMMER

Accessoires - Netskim - Chaussettes pour skimmer



	DÉSIGNATION	UT	CODE	PPHT (€)
902.0011.60	NETSKIM -BOITE DE 12- 042747	U	0455N.2	14,50

PISCINE

PIECES A SCELLER POUR PISCINE



PROJECTEUR - OPTIQUE

Led LumiPlus - Lampe Par56 V2



	DÉSIGNATION	UT	CODE	PPHT (€)
902.0303.00	LAMPE LED LUMIPLUS 1.11 +TELEC. -1- 59126	U	0051M.2	404,00



PROJECTEUR - OPTIQUE

Boîte de connexion



	DÉSIGNATION	UT	CODE	PPHT (€)
902.0018.28	BOITE DE CONNEXION D.50MM 045235 65215	U	1290Q.5	22,85



REFOULEMENT - PRISE DE BALAI

Multiflow - Bouche de refoulement



	DÉSIGNATION	UT	CODE	PPHT (€)
902.0004.18	BOUCHE REFOUL.MULTIFLOW STD BETON 17239	U	48447.7	5,57



REFOULEMENT - PRISE DE BALAI

Traversée de paroi - Piscine béton



	DÉSIGNATION	UT	CODE	PPHT (€)
902.0008.39	TRAVERSEE DE PAROI 30CM 042006 15658	U	48481.6	8,39



REFOULEMENT - PRISE DE BALAI

Bouche et prise balai - Prise balai



	DÉSIGNATION	UT	CODE	PPHT (€)
902.0004.74	BOUCHE ASPIRATION BETON STANDARD 041524 17240	U	95563.3	4,74

NETTOYAGE ET ENTRETIEN DE PISCINE



ENTRETIEN MANUEL

Absorbant actif - Water Lily®



	DÉSIGNATION	UT	CODE	PPHT (€)
902.0010.00	ABSORBANT GRAISSE WATER LILY -BTE 6- 042744	U	3030G.3	12,50

PISCINE

NETTOYAGE ET ENTRETIEN DE PISCINE



ENTRETIEN MANUEL

Brosse/éponge - Brosse courbe



	DÉSIGNATION	UT	CODE	PPHT (€)
902.0007.88	BROSSE COURBE CLIP RENF.ALU 044611 T51B/CB/24	U	48455.0	10,50



ENTRETIEN MANUEL

Brosse/éponge - Ligne d'eau



	DÉSIGNATION	UT	CODE	PPHT (€)
902.0002.64	EPONGE LIGNE D EAU 044612 T98/CB/24	U	7079T.3	3,52



ENTRETIEN MANUEL

Tête de balai aspirateur manuel - Piscine liner



	DÉSIGNATION	UT	CODE	PPHT (€)
902.0010.53	BALAI LINER TRIANG.BLEU CLIP 044911 T67B/CS/6	U	95490.9	14,04
902.0009.29	ASPIRATEUR LINER CLIP BROSS.LAT. T90S/CS/12	U	214RY.6	12,39



ENTRETIEN MANUEL

Tuyau flottant - Avec embouts



	DÉSIGNATION	UT	CODE	PPHT (€)
902.0028.39	TUYAU FLOTTANT D38 10M +EMB.044301 01377-2450	U	24029.1	37,85



ENTRETIEN MANUEL

Manche de balai - Blocage externe



	DÉSIGNATION	UT	CODE	PPHT (€)
902.0019.24	MANCHE TELESCOP.3M60 BLOC.EXT. T85/DGL/BU/12/	U	40286.5	25,65



ENTRETIEN MANUEL

Époussette de fond - A clip



	DÉSIGNATION	UT	CODE	PPHT (€)
902.0007.84	EPUISSETTE DE FOND STANDARD CLIP T604E/CB/12	U	5944P.8	10,45

Le PPHT comprend l'ecopart (€)

PISCINE

NETTOYAGE ET ENTRETIEN DE PISCINE



ENTRETIEN MANUEL

Époussette de surface - A clip



	DÉSIGNATION	UT	CODE	PPHT (€)
902.0007.30	EPUISSETTE DE SURFACE CLIP 044631 T603E/CB/12	U	48458.4	9,74



ROBOT DE PISCINE

Dolphin



	DÉSIGNATION	UT	CODE	PPHT (€)	ECOPART (€)
000.0949.73	ROBOT PISCINE E35 DOLPHIN 9996211-E35	U	299MM.9	951,06	1,33

TRAITEMENT DE L'EAU POUR PISCINE



EQUILIBRE DE L'EAU

PH-



	DÉSIGNATION	UT	CODE	PPHT (€)
903.0011.28	PH MINUS POUDRE -SEAU 5KG- A01005	U	284XR.8	14,10



EQUILIBRE DE L'EAU

PH- - Liquide



	DÉSIGNATION	UT	CODE	PPHT (€)
903.0014.40	PH MINUS LIQUIDE 15% 101510CAVP-10L- A01510VL	U	307LZ.7	18,00



EQUILIBRE DE L'EAU

PH+



	DÉSIGNATION	UT	CODE	PPHT (€)
903.0012.24	PH PLUS POUDRE -SEAU 5KG- A02005	U	284XX.5	15,30



BROME

Multi-actions



	DÉSIGNATION	UT	CODE	PPHT (€)
903.0073.52	REGENERATEUR BROME -5KG- A13105	U	272EW.5	91,90

PISCINE

TRAITEMENT DE L'EAU POUR PISCINE

ASTRALPOOL 

CHLORE

Choc



	DÉSIGNATION	UT	CODE	PPHT (€)
903.0045.00	CHLORE CHOC 20G LOW BORIC -S.5KG- A25005L	U	3520R.0	45,00

ASTRALPOOL 

CHLORE

Chlore non stabilisé - Liquide



	DÉSIGNATION	UT	CODE	PPHT (€)
903.0044.40	CHLORE LIQUIDE ANTI-TARTRE -BIDON 20L- A10021	U	284X5.1	55,50

ASTRALPOOL 

CHLORE

Lent - CTX 373



	DÉSIGNATION	UT	CODE	PPHT (€)
903.0039.90	CHLORE LENT GAL.250G -5KG- A37305L	U	355T2.0	39,90

ASTRALPOOL 

CHLORE

Aquasoleil - Multi-action



	DÉSIGNATION	UT	CODE	PPHT (€)
000.0041.00	CHLORE MULT.250G 1192SP25051AVP -5KG- A39305L	U	351W6.5	41,00

ASTRALPOOL 

ANTI-ALGUES

Moutarde



	DÉSIGNATION	UT	CODE	PPHT (€)
903.0039.96	ANTI-ALGUES MOUTARDE 00171AGAVP-1.5KG- A01701	U	284Y2.7	49,95

ASTRALPOOL 

ANTI-ALGUES



	DÉSIGNATION	UT	CODE	PPHT (€)
903.0008.80	ANTI-ALGUES LIQUIDE 050005CAVP -5L- A50005	U	284XS.6	11,00

PISCINE

TRAITEMENT DE L'EAU POUR PISCINE

ASTRALPOOL 

DOSAGE REGULATION

Pompe doseuse - Micro



	DÉSIGNATION	UT	CODE	PPHT (€)
902.0238.88	POMPE DOS.PERISTALTIQUE MICRO PH S08AA0116818	U	7418X.4	318,50

ASTRALPOOL 

ANALYSE DE L'EAU

Bandelette et lecteur - Aquacheck -Bandelette



	DÉSIGNATION	UT	CODE	PPHT (€)
903.0014.89	BANDELETTE AQUACHEK SEL BLANC 046493 561141A	U	07765.1	19,85
903.0011.20	BANDELETTE AQUACHEK CH/PH/ALC/STAB JNE 11732	U	5948T.6	14,94
903.0022.32	BANDELETTE AQUACHEK 7 FONCT.046483 -50- 30865	U	9135N.1	27,90



SEL

Adoucisseur



	DÉSIGNATION	UT	CODE	PPHT (€)
050.0014.67	SEL ADOUCISSEUR 25 KG NF SEL25KGNF	U	387K8.6	18,34

ACCESSOIRES POUR PISCINE

ASTRALPOOL 

ACCESSOIRE PVC

Collecteur - Bouchon non collé



	DÉSIGNATION	UT	CODE	PPHT (€)
902.0024.79	COLLECTEUR PVC D.63MM 042001D63 C-00163	U	5973V.9	33,05

ASTRALPOOL 

ACCESSOIRE PVC

Raccord - Tournant Ø 38 mm, à visser 1"1/2



	DÉSIGNATION	UT	CODE	PPHT (€)
902.0002.08	RACCORD TOURNANT FILETE M 1"1/2 042040 01393	U	84090.0	2,78

PISCINE

ACCESSOIRES POUR PISCINE

ASTRALPOOL

ACCESSOIRE PVC

Tube



	DÉSIGNATION	UT	CODE	PPHT (€)
000.0006.06	TUBE PVC PN16 D50 1M -1- 043053BOX	U	307AN.0	6,06
000.0010.55	TUBE PVC PN16 D63 1M -1- 043054BOX	U	307AP.8	10,55

ASTRALPOOL

ACCESSOIRE PVC

Tuyau PVC - Flexible Idroflex



	DÉSIGNATION	UT	CODE	PPHT (€)
902.0093.75	TUYAU FLEX.IDROFLEX D50 L25 043114L25 69857	U	182YC.1	125,00
902.0187.50	TUYAU FLEX.IDROFLEX D50 L50 043114L50 69856	U	214S1.2	250,00
902.0144.38	TUYAU FLEX.IDROFLEX D63 L25 043115L25 69858	U	224X2.4	192,50

ASTRALPOOL

THERMOMETRE

Flottant



	DÉSIGNATION	UT	CODE	PPHT (€)
902.0005.12	THERMOMETRE DAUPHIN BLEU 046535D T381D/CS/24	U	4176U.9	6,40

Pour plus d'infos,
consultez
le CAHIER TECHNIQUE
page 14

J+0 100% DISPO



L'atout LIBRE-SERVICE

- Un large choix de produits
- Tous les produits de ce catalogue à votre disposition
- Une équipe à votre service

GAMME VMC HYGRORÉGLABLE

la ventilation qui réduit votre facture d'énergie !



Ventilation HYGRORÉGLABLE

Économe en énergie
Généreuse en confort !

- Jusqu'à **58 % d'économies d'énergie***
- Retour sur investissement : **17 mois**
- Jusqu'à **1 classe gagnée** sur le DPE

*Consommation calculée sur la zone H2 et dans une maison moyenne de 111 m², à effet joule. Sur la base de calcul des déperditions énergétiques + consommation VMC de 2 217 kWh pour une VMC Auto VS 923 kWh pour une ventilation hygro-réglable et un tarif de l'électricité à 0,227 € / kWh.

• MARQUE FRANÇAISE • RECOMMANDÉE PAR LES PROFESSIONNELS • SOLUTIONS CONNECTÉES

Climatisation et Ventilation

SOMMAIRE

CLIMATISATION

CLIMATISEUR FIXE MONO-SPLIT	290
CLIMATISEUR MONOBLOC	293
CLIMATISEUR FIXE MULTI-SPLIT	293
CLIMATISEUR GAINABLE	295
CLIMATISEUR MOBILE	296
LIAISON FRIGORIFIQUE	296
RACCORDS FRIGORIFIQUE A BRASER	296
RACCORDS FRIGORIFIQUE A SERTIR	298
REGULATION	299
CONDENSATS	300
GOULOTTE	303
PLENUM CLIM	306
PLENUM REGULATION	306
HABILLAGE	307
SUPPORTS ET FIXATIONS	307
ENTRETIEN	308

VENTILATION

VMC INDIVIDUELLE AUTOREGLABLE	311
VMC INDIVIDUELLE HYGROREGLABLE	311
VMC COLLECTIVE	312
VMC TERTIAIRE	312
GAINES ET CONDUITS RESIDENTIEL	312
GAINES ET CONDUITS TERTIAIRE	313
GRILLE ET DIFFUSEUR	314
DISTRIBUTION D'AIR ET CONDUITS	316
BOUCHES ET ENTREE D'AIR	320
EXTRACTEUR INDEPENDANT	322

CLIMATISATION

CLIMATISEUR FIXE MONO-SPLIT

atlantic

CLIMATISEUR MURAL

FUJITSU - KATA - DC Inverter - Réversible - Unité extérieure



	DÉSIGNATION	UT	CODE	PPHT (€)	ECOPART (€)
573.1341.99	CLIM.U.E.MONO.AOYG 24 KATA 6800W R32 872142	U	310TG.4	2690,66	6,67

atlantic

CLIMATISEUR MURAL

Gamme ZENKEO - Climatiseur mural R32 - Unité intérieure



	DÉSIGNATION	UT	CODE	PPHT (€)	ECOPART (€)
573.0239.50	CLIM.U.I. ZENKEO AS 007 NBB R32 2000W 873833	U	388CB.2	480,67	1,67
573.0260.00	CLIM.U.I. ZENKEO AS 009 NBB R32 2500W 873834	U	388CD.8	521,67	1,67
573.0328.50	CLIM.U.I. ZENKEO AS 012 NBB R32 3500W 873835	U	37466.9	658,67	1,67
573.0515.50	CLIM.U.I. ZENKEO AS 018 NBB R32 5000W 873836	U	A00J1.6	1032,67	1,67

atlantic

CLIMATISEUR MURAL

Gamme ZENKEO - Climatiseur mural R32 - Unité extérieur



	DÉSIGNATION	UT	CODE	PPHT (€)	ECOPART (€)
573.0796.00	CLIM.U.E.MUR.ZENKEO 018 NBRB.UE 5000W 872148	U	395ZK.2	1598,67	6,67

BOSCH

CLIMATE 3000I

Unité extérieure pompe à chaleur air/air monosplit - R32

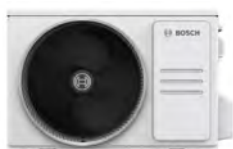

	DÉSIGNATION	UT	CODE	PPHT (€)	ECOPART (€)
000.0373.50	CLIM.U.E.MONO.CL3000I 26 E 2.6KW 7733701565	U	300J2.0	504,67	6,67
000.0401.25	CLIM.U.E.MONO.CL3000I 35 E 3.5KW 7733701567	U	300J4.6	541,67	6,67
000.0690.75	CLIM.U.E.MONO.CL3000I 53 E 5.3KW 7733701569	U	300J5.3	927,67	6,67

BOSCH

CLIMATE 5000L

Pompe à chaleur air/air Unité extérieure monosplit - R32



	DÉSIGNATION	UT	CODE	PPHT (€)	ECOPART (€)
000.1340.98	CLIM.U.E.MONO.CL5000L 70E 7KW R32 7733701871	U	354ZT.3	1794,65	6,67

CLIMATISATION

CLIMATISEUR FIXE MONO-SPLIT

BOSCH

CLIMATE 6000I

Pompe à chaleur air/air Unité extérieure monosplit - R32



	DÉSIGNATION	UT	CODE	PPHT (€)	ECOPART (€)
000.0417.00	CLIM.U.E.CLIMATE 6000I 2.6KW 7733701807	U	352BK.1	562,67	6,67
000.0453.00	CLIM.U.E.CLIMATE 6000I 3.5KW 7733701809	U	352BL.9	610,67	6,67
000.0724.50	CLIM.U.E.CLIMATE 6000I 5.3KW 7733701811	U	352BM.7	972,67	6,67

BOSCH

CLIMATE CLASS 8000I

Pompe à chaleur air/air Unité intérieure monosplit - R32



	DÉSIGNATION	UT	CODE	PPHT (€)	ECOPART (€)
504.0185.25	CLIM.U.I.MUR.CL3000I U W 20 E 2KW 7733701997	U	396W2.1	248,67	1,67

DAIKIN

MURAL

FTXF-A/B /RXF-A/B/C/D - Sensira Bluevolution - Unité intérieure - FTXF-D



	DÉSIGNATION	UT	CODE	PPHT (€)	ECOPART (€)
575.0430.65	CLIM.U.I.SENSIRA BLUEVOL. 5KW FTXF50D	U	332N8.6	785,08	2,08
575.0469.15	CLIM.U.I.SENSIRA BLUEVOL. 6KW FTXF60D	U	332NA.1	855,08	2,08

DAIKIN

MURAL

FTXF-A/B /RXF-A/B/C/D - Sensira Bluevolution - Unité intérieure - FTXF-E



	DÉSIGNATION	UT	CODE	PPHT (€)	ECOPART (€)
575.0281.05	CLIM.U.I.SENSIRA BLUEVOL.2.5KW R32 FTXF25E	U	394VW.6	512,04	1,04
575.0354.75	CLIM.U.I.SENSIRA BLUEVOL.3.5KW R32 FTXF35E	U	394VX.4	646,04	1,04
575.0397.10	CLIM.U.I.SENSIRA BLUEVOL.4.2KW R32 FTXF42E	U	394VY.2	723,04	1,04

DAIKIN

MURAL

FTXF-A/B /RXF-A/B/C/D - Sensira Bluevolution - Unité extérieure - RXF-D



	DÉSIGNATION	UT	CODE	PPHT (€)	ECOPART (€)
575.0926.20	CLIM.U.E.SENSIRA 5KW RXF50D	U	332NL.9	1690,67	6,67
575.1093.94	CLIM.U.E.SENSIRA 6KW RXF60D	U	332NM.7	1995,66	6,67

Le PPHT comprend l'ecopart (€)

CLIMATISATION

CLIMATISEUR FIXE MONO-SPLIT



MURAL

SENSIRA Pompe à chaleur AIR / AIR mural
- Groupe extérieur - R32



	DÉSIGNATION	UT	CODE	PPHT (€)	ECOPART (€)
575.0447.15	CLIM.U.E.SENSIRA BLUEVOL.2KW R32 RXF20E	U	394VZ.1	819,67	6,67
575.0740.30	CLIM.U.E.SENSIRA BLUEVOL.4.2KW R32 RXF42E	U	394WZ.6	1352,67	6,67
575.0470.80	CLIM.U.E.SENSIRA BLUEVOL.2.5KW R32 RXF25E	U	394W0.0	862,67	6,67



MURAL

Gamme Perfera - CTXM-M/FTXM-M-R/RXM-R-M-N(9)/RXM-N - Bluevolution - Unité intérieure - FTXM-R



	DÉSIGNATION	UT	CODE	PPHT (€)	ECOPART (€)
575.0583.00	CLIM.U.I.MONO.PERFERA BLUEVO.2KW FTXM20R	U	286HD.9	585,08	2,08
575.1024.00	CLIM.U.I.MONO.PERFERA BLUEVO.4.2KW FTXM42R	U	286HG.2	1026,08	2,08
575.1074.00	CLIM.U.I.MONO.PERFERA BLUEVO.5KW FTXM50R	U	286HH.0	1076,08	2,08



MURAL

Gamme Perfera - CTXM-M/FTXM-M-R/RXM-R-M-N(9)/RXM-N - Bluevolution - Unité extérieure RXM-R



	DÉSIGNATION	UT	CODE	PPHT (€)	ECOPART (€)
575.0630.50	CLIM.U.E.MONO.PERFERA BLUEV.2.5KW RXM25R9	U	332PX.0	1267,67	6,67
575.1832.99	CLIM.U.E.MONO.PERFERA BLUEV.4.2KW RXM42R	U	286HV.4	1839,66	6,67
575.2256.99	CLIM.U.E.MONO.PERFERA BLUEV.5KW RXM50R	U	286HW.2	2263,66	6,67
575.0565.00	CLIM.U.E.MONO.PERFERA BLUEV.2KW RXM20R9	U	332PW.2	1136,67	6,67
575.0731.00	CLIM.U.E.MONO.PERFERA BLUEV.3.5KW RXM35R9	U	332PY.8	1468,67	6,67



MURAL

PERFERA R32 - Unité intérieure



	DÉSIGNATION	UT	CODE	PPHT (€)	ECOPART (€)
999.0604.00	CLIM.U.I.MONO.PERFERA BLUEVO.2.5KW FTXM25A	U	A089U.1	604,00	
999.0793.00	CLIM.U.I.MONO.PERFERA BLUEVO.3.5KW FTXM35A	U	A089W.7	793,00	



CONSOLE

FVXM-F - Double flux - DC Inverter - Réversible - Unité intérieure



	DÉSIGNATION	UT	CODE	PPHT (€)	ECOPART (€)
575.1143.44	CLIM.U.I.CONSOLE SPLIT 5KW R32 BLC FVXM50F	U	9434U.6	2083,16	4,17

CLIMATISATION

CLIMATISEUR FIXE MONO-SPLIT



CONSOLE

FVXM-A - Double flux - R32



	DÉSIGNATION	UT	CODE	PPHT (€)	ECOPART (€)
575.1964.00	CLIM.U.I.CONSOLE PERFERA BLUEV.3.5KW FVXM35A	U	286NQ.9	1968,17	4,17



Changes for the Better

MURAL

MUZ-AY - Groupe extérieur série M - Inverter Mono-split



	DÉSIGNATION	UT	CODE	PPHT (€)	ECOPART (€)
931.0927.00	CLIM.U.E.MONO INV.1.5KW 674827 MUZ-AY15VG-E1	U	A072P.1	933,67	6,67
931.0495.50	CLIM.U.E.MONO INV.2.0KW 605410 MUZ-AY20VG-E1	U	A09P6.6	997,67	6,67
931.0551.50	CLIM.U.E.MONO INV.2.5KW 605418 MUZ-AY25VG-E1	U	402P2.4	1109,67	6,67
931.0713.00	CLIM.U.E.MONO INV.3.5KW 605419 MUZ-AY35VG-E1	U	400ZT.4	1432,67	6,67
931.1067.00	CLIM.U.E.MONO INV.4.2KW 605420 MUZ-AY42VG-E1	U	402P6.5	2140,67	6,67
931.1221.49	CLIM.U.E.MONO INV.5KW 605421 MUZ-AY50VG-E1	U	397QD.1	2449,66	6,67



Changes for the Better

MURAL

MUZ-LN-VGHZ - Inverter Hyper Heating - Unité extérieure - Série M



	DÉSIGNATION	UT	CODE	PPHT (€)	ECOPART (€)
931.1708.99	CLIM.U.E.MONO INV.2KW 577918 MUZ-LN25VGHZ-E2	U	332DT.5	1715,66	6,67
931.1967.99	CLIM.U.E.MONO INV.3.5 577920 MUZ-LN35VGHZ-E2	U	332DU.2	1974,66	6,67
931.2924.99	CLIM.U.E.SERIE M 5KW 584446 MUZ-LN50VGHZ-E2	U	333S4.4	2931,66	6,67



Changes for the Better

MURAL

MSZ/MUZ-AP-VG-VGK - Inverter Compact - Unité intérieure



	DÉSIGNATION	UT	CODE	PPHT (€)	ECOPART (€)
931.0340.50	CLIM.U.I.MUR.COMP.2.0KW 598934 MSZ-AP20VGK-E2	U	288V7.0	682,04	1,04
931.1331.00	CLIM.U.I.GRDE PCES 6.1KW 599884 MSZ-AP60VG-E3	U	344UY.8	1335,17	4,17
931.0876.50	CLIM.U.I.GRDE PCES 7.1KW 599885 MSZ-AP71VG-E3	U	349PX.4	1757,17	4,17



Changes for the Better

MURAL

MSZ/MUZ-AP-VG-VGK - Inverter Compact - Unité extérieure



	DÉSIGNATION	UT	CODE	PPHT (€)	ECOPART (€)
931.0991.00	CLIM.U.E.MONO INV.2KW 577899 MUZ-AP20VG-E2	U	332D1.1	997,67	6,67
931.0535.00	CLIM.U.E.MUR.INV.COMP.NO.413647 MUZ-AP25VG-E2	U	219D5.1	1076,67	6,67
931.1335.50	CLIM.U.E.SERIE M 6.1KW 577912 MUZ-AP60VG-E2	U	327WM.4	2677,67	6,67
931.1658.49	CLIM.U.E.SERIE M 7.1KW 577896 MUZ-AP71VG-E2	U	332DA.1	3323,66	6,67

Le PPHT comprend l'ecopart (€)

CLIMATISATION

CLIMATISEUR FIXE MONO-SPLIT



Changes for the Better

MURAL

MSZ/MUZ-AP-VG-VGK - Inverter Compact - Unité extérieure - suite



DÉSIGNATION	UT	CODE	PPHT (€)	ECOPART (€)
931.1426.00 CLIM.U.E.MONO INV.3.5KW 502161 MUZ-AP35VG-E3	U	289KR.4	1432,67	6,67



Changes for the Better

MURAL

MSZ/MUZ-AY - Inverter Compact - Unité intérieure



DÉSIGNATION	UT	CODE	PPHT (€)	ECOPART (€)
931.0340.50 CLIM.U.I.MUR.COMP.2.0KW 605381 MSZ-AY20VGK-E1	U	427FH.2	682,04	1,04



Changes for the Better

MURAL

MSZ/MUZ-EF-VE/VG/VGKB/VGKS/VGKW - Inverter - Design - Unité intérieure - EF-VG-VGKB-VGKS-VGKW - Design



DÉSIGNATION	UT	CODE	PPHT (€)	ECOPART (€)
931.0584.50 CLIM.U.I.MUR.DES.3.5KW 675614 MSZ-EF35VGKW-E2	U	416L4.8	1171,08	2,08
931.0489.50 CLIM.U.I.MUR.DES.2.5KW 487068 MSZ-EF25VGKW-E1	U	271SV.1	981,08	2,08



Changes for the Better

MURAL

MSZ/MUZ-EF-VE/VG/VGKB/VGKS/VGKW - Inverter - Design - Unité extérieure - EF-VG - Design



DÉSIGNATION	UT	CODE	PPHT (€)	ECOPART (€)
931.0713.00 CLIM.UE SERIE M INV.3.5 404945 MUZ-EF35VG-E1	U	223Y5.8	1432,67	6,67



Changes for the Better

MURAL

MSZ/MUZ-HR-VF - Essentiel - Inverter - Réversible - Unité intérieure



DÉSIGNATION	UT	CODE	PPHT (€)	ECOPART (€)
931.0285.50 CLIM.U.I.MUR.ESS.2.5KW 606062 MSZ-HR25VF-E2	U	346W7.5	572,04	1,04
931.0347.50 CLIM.U.I.MUR.ESS.3.1KW 606063 MSZ-HR35VF-E2	U	346W8.3	696,04	1,04
562.0458.50 CLIM.U.I.MUR.ESS.4.2KW 690158 MSZ-HR42VF-E3	U	A0BRZ.2	918,04	1,04
931.0520.50 CLIM.U.I.MUR.ESS.5.0KW 606065 MSZ-HR50VF-E2	U	346V8.4	1042,04	1,04
931.0546.50 CLIM.U.I.MUR.ESS.6.1KW 604195 MSZ-HR60VF-E3	U	35568.4	1095,08	2,08
931.1398.00 CLIM.U.I.MUR.ESS.7.1KW 604197 MSZ-HR71VF-E3	U	3556F.8	1400,08	2,08

CLIMATISATION

CLIMATISEUR FIXE MONO-SPLIT



Changes for the Better

MURAL

MSZ/MUZ-HR-VF - Essentiel - Inverter - Réversible - Groupe exérieur



DÉSIGNATION	UT	CODE	PPHT (€)	ECOPART (€)
931.0356.50 CLIM.U.E.MONO INV.2.5KW 627001 MUZ-HR25VF-E3	U	A00QE.6	719,67	6,67
931.0440.50 CLIM.U.E.MONO INV.3.5KW 627192 MUZ-HR35VF-E3	U	A00QF.4	887,67	6,67
931.0686.00 CLIM.U.E.MONO INV.4.2KW 627193 MUZ-HR42VF-E3	U	395JE.3	1378,67	6,67
931.0780.00 CLIM.U.E.MONO INV.5KW 627194 MUZ-HR50VF-E3	U	395SJ.1	1566,67	6,67
931.1018.50 CLIM.U.E.MONO INV.6.1KW 604198 MUZ-HR60VF-E3	U	356TY.3	2043,67	6,67
931.1297.99 CLIM.U.E.MONO INV.7.1KW 604199 MUZ-HR71VF-E3	U	356TZ.2	2602,66	6,67



Changes for the Better

MURAL

MSZ-LN/VGV-VGB - Mural Design De Luxe - Unité intérieure



DÉSIGNATION	UT	CODE	PPHT (€)	ECOPART (€)
931.0586.00 CLIM.U.I.MUR.LUX.2.5KW 599430 MSZ-LN25VG2V-E2	U	374E9.5	1176,17	4,17
931.1416.00 CLIM.U.I.MUR.LUX.3.5KW 599524 MSZ-LN35VG2V-E1	U	361JR.2	1420,17	4,17
931.1255.00 CLIM.U.I.MUR.LUX.3.5KW 472968 MSZ-LN35VG2V-E2	U	266L6.2	1259,17	4,17
931.0830.49 CLIM.U.I.MUR.LUX.5.0KW 599530 MSZ-LN50VG2B-E2	U	366ST.4	1665,16	4,17
931.0769.50 CLIM.U.I.MUR.LUX.5.0KW 599527 MSZ-LN50VG2V-E2	U	363HZ.4	1543,17	4,17
931.1660.99 CLIM.U.I.MUR.LUX.5.0KW 599528 MSZ-LN50VG2V-E2	U	361K9.6	1665,16	4,17



Changes for the Better

MURAL

MXZ-HA-VF - Inverter Multi-split Essentiel - Monophasé R32 - Unité extérieure



DÉSIGNATION	UT	CODE	PPHT (€)	ECOPART (€)
931.0898.00 CLIM.U.E.MULTI 4KW 675722 MXZ-2HA40VF2-E1	U	A01EV.8	1802,67	6,67
931.1431.00 CLIM.U.E.MULTI 5KW 675724 MXZ-3HA50VF2-E1	U	405MR.4	2868,67	6,67



Changes for the Better

CONSOLE

MFZ-KT/VG - Unité intérieure



DÉSIGNATION	UT	CODE	PPHT (€)	ECOPART (€)
931.0803.99 CLIM.U.I.SERIE M 2.5KW 596883 MFZ-KT25VG-E2	U	343D8.3	1610,07	2,08
931.1747.99 CLIM.U.I.SERIE M 3.5KW 596884 MFZ-KT35VG-E2	U	350SE.5	1750,07	2,08
931.1890.99 CLIM.U.I.SERIE M 5KW 596888 MFZ-KT50VG-E2	U	352MW.7	1893,07	2,08

Le PPHT comprend l'ecopart (€)

CLIMATISATION

CLIMATISEUR FIXE MONO-SPLIT



Changes for the Better

CASSETTE

SLZ-M - Mini-cassette 4 voies -
Inverter - Unité intérieure



	DÉSIGNATION	UT	CODE	PPHT (€)
931.0797.50	CLIM.U.I.CAS.4V.600 INV. 312214 SLZ-M35FA.TH	U	179A4.3	1595,00
931.0856.00	CLIM.U.I.CAS.4V.600 INV. 312215 SLZ-M50FA.TH	U	179A5.0	1712,00



Changes for the Better

ACCESSOIRES

Filtre Plasma Quad Connect



	DÉSIGNATION	UT	CODE	PPHT (€)	ECOPART (€)
931.0157.60	FILTRE PLASMA QUAD CONNECT 581155 MAC-100FT-E	U	326Z1.7	197,21	0,21

CLIMATISEUR MONOBLOC



HOME OF COMFORT

UNICO AIR - SLIM DESIGN

Climatiseur mural sans unité
extérieure - Le plus fin seulement 16
cm d'épaisseur - R410A



	DÉSIGNATION	UT	CODE	PPHT (€)
578.1250.00	CLIM.UNICO AIR 8HP 1.8KW 01504	U	286X8.0	2500,00



HOME OF COMFORT

UNICO AIR - GAZ A FAIBLE PRG

Climatiseur mural sans unité
extérieure - Le plus fin, avec
compresseur Inverter et gaz R32



	DÉSIGNATION	UT	CODE	PPHT (€)
578.1469.99	CLIM.UNICO AIR 20 HP EVA 1.7KW 02111	U	296XG.1	2939,99

Pour plus d'infos,
consultez
le CAHIER TECHNIQUE
page 14

Le PPHT comprend l'ecopart (€)

CLIMATISATION

CLIMATISEUR FIXE MULTI-SPLIT

atlantic

UNITE EXTERIEURE

FUJITSU - DC Inverter - réversible - R410A
- 2 postes



	DÉSIGNATION	UT	CODE	PPHT (€)	ECOPART (€)
573.1132.00	CLIM.U.E.REV.2 S.R32 AOYG14KBT2 4000W 872095	U	221W8.8	2270,67	6,67

atlantic

UNITE EXTERIEURE

FUJITSU - DC Inverter - réversible - R410A
- 3 postes



	DÉSIGNATION	UT	CODE	PPHT (€)	ECOPART (€)
573.1613.99	CLIM.U.E.MULTI.R32 AOYG18KBT3 5400W 872126	U	289B6.4	3234,66	6,67
573.1923.50	CLIM.U.E.MULTI.R32 AOYG24KBT3 6800W 872127	U	289BF.4	3853,67	6,67

atlantic

UNITE EXTERIEURE

FUJITSU - DC Inverter - réversible -
R410A - 4 postes



	DÉSIGNATION	UT	CODE	PPHT (€)	ECOPART (€)
573.2600.49	CLIM.U.E.MULTI.R32 AOYG30KBT4 8000W 872128	U	289BK.5	5207,66	6,67

atlantic

UNITE EXTERIEURE

Multisplit - Muraux Inverter - Tri-splits



	DÉSIGNATION	UT	CODE	PPHT (€)	ECOPART (€)
573.1450.50	CLIM.U.E.3U 024 NB MULTI-SPLIT 6200W 872942	U	252F0.1	2907,67	6,67

atlantic

UNITE EXTERIEURE

Multisplit - Muraux Inverter - Quintuple-split



	DÉSIGNATION	UT	CODE	PPHT (€)	ECOPART (€)
572.2188.49	CLIM.U.E.5U 036 NB MULTI-SPLIT 9500W 872948	U	289BS.1	4383,66	6,67

CLIMATISATION

CLIMATISEUR FIXE MULTI-SPLIT



CLIMATE 3000I

Pompe à chaleur air/air Unité intérieure mono/multisplit - R32



	DÉSIGNATION	UT	CODE	PPHT (€)	ECOPART (€)
000.0205.50	CLIM.UI.MUR.CL3000IU W 26 E 2.6KW 7733701564	U	300HV.3	275,67	1,67
000.0233.25	CLIM.UI.MUR.CL3000IU W 35 E 3.5KW 7733701566	U	300HX.9	312,67	1,67
000.0354.75	CLIM.UI.MUR.CL3000IU W 53 E 5.3KW 7733701568	U	300HY.7	474,67	1,67
000.0411.00	CLIM.UI.MUR.CL3000IU W 70 E 7KW 7733701570	U	300J1.2	549,67	1,67



CLIMATE 5000M

Pompe à chaleur air/air Unité extérieure bisplit - R32



	DÉSIGNATION	UT	CODE	PPHT (€)	ECOPART (€)
000.0896.25	CLIM.U.E.CLIM.5000 M 41/2 E 4.1KW 7733701932	U	396W5.4	1201,67	6,67
000.1115.25	CLIM.U.E.CLIM.5000 M 53/2 E 5.3KW 7733701933	U	396W7.0	1493,67	6,67



CLIMATE 5000M

Pompe à chaleur air/air Unité extérieure trisplit - R32



	DÉSIGNATION	UT	CODE	PPHT (€)	ECOPART (€)
504.1395.00	CLIM.U.E.CLIM.5000 M 62/3 E 6.2KW 7733701934	U	396W8.8	1866,67	6,67
000.1662.00	CLIM.U.E.CLIM.5000 M 79/3 E 7.9KW 7733701935	U	396W9.6	2222,67	6,67



CLIMATE 6000I

Pompe à chaleur air/air Unité intérieure mono/multisplit - R32 - Sans clé Wifi



	DÉSIGNATION	UT	CODE	PPHT (€)	ECOPART (€)
000.0254.25	CLIM.U.I.CLIMATE 6000I 2.6KW 7733701806	U	352BP.3	340,67	1,67
000.0299.25	CLIM.U.I.CLIMATE 6000I 3.5KW 7733701808	U	352BQ.1	400,67	1,67
000.0381.75	CLIM.U.I.CLIMATE 6000I 5.3KW 7733701810	U	352BR.9	510,67	1,67



UNITE INTERIEURE

CTXM-M/N/R - DC inverter R410A - Réversible - CTXM-R



	DÉSIGNATION	UT	CODE	PPHT (€)	ECOPART (€)
575.0565.00	CLIM.U.I.MONO.PERFERA BLUEVO.1.5KW CTXM15R	U	286HA.5	567,08	2,08

CLIMATISATION

CLIMATISEUR FIXE MULTI-SPLIT



UNITE EXTERIEURE

2MXM-M/N/M(9) - Bluevolution - 2 sorties



	DÉSIGNATION	UT	CODE	PPHT (€)	ECOPART (€)
000.1140.00	CLIM.U.E.MULTI.BLUEVOLUTION 4KW 2MXM40N9	U	346DR.9	2286,67	6,67



UNITE EXTERIEURE

3MXM-M/N - Bluevolution - 3 sorties



	DÉSIGNATION	UT	CODE	PPHT (€)	ECOPART (€)
000.1370.49	CLIM.U.E.MULTI.BLUEVOLUTION 4KW 3MXM40N7	U	346DS.7	2747,66	6,67
575.1609.00	CLIM.U.E.MULTI.BLUEVOLUTION 5.2KW 3MXM52N7	U	338KA.1	3224,67	6,67
575.2130.14	CLIM.U.E.MULTI.BLUEVOLUTION 6.8KW 3MXM68N9	U	313ME.3	3879,66	6,67



UNITE EXTERIEURE

FREE MATCH - Bisplit R32



	DÉSIGNATION	UT	CODE	PPHT (€)	ECOPART (€)
562.0866.09	CLIM.UE F-MATCH 14 BI-SPLIT 4.1KW 3NGR4525	U	362EU.8	1740,72	8,55
562.0907.89	CLIM.UE F-MATCH 18 BI-SPLIT 5.3KW 3NGR4526	U	362EW.4	1824,32	8,55



UNITE EXTERIEURE

FREE MATCH - Trisplit



	DÉSIGNATION	UT	CODE	PPHT (€)	ECOPART (€)
562.1307.27	CLIM.UE F-MATCH 24 TRI-SPLIT 7.1KW 3NGR4528	U	362EY.0	2623,08	8,55



UNITE INTERIEURE

SLZ-M - Inverter - Réversible - Cassette 4 voies 600x600



	DÉSIGNATION	UT	CODE	PPHT (€)	ECOPART (€)
931.0623.50	CLIM.U.I.CAS.4V.600 INV. 598708 SLZ-M25FA2.TH	U	353TC.3	1247,00	



UNITE INTERIEURE

MSZ-AY - Unité Intérieure Série M - Mural compact

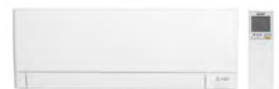

	DÉSIGNATION	UT	CODE	PPHT (€)	ECOPART (€)
931.0323.50	CLIM.U.I.MUR.COMP.1.5KW 605380 MSZ-AY15VGK-E1	U	427FF.6	648,04	1,04
931.0361.50	CLIM.U.I.MUR.COMP.2.5KW 605402 MSZ-AY25VGK-E1	U	A00Q3.1	725,08	2,08

Le PPHT comprend l'ecopart (€)

CLIMATISATION

CLIMATISEUR FIXE MULTI-SPLIT



UNITE INTERIEURE

MSZ-AY - Unité Intérieure Série M - Mural compact - suite



	DÉSIGNATION	UT	CODE	PPHT (€)	ECOPART (€)
931.0415.50	CLIM.U.I.MUR.COMP.3.5KW 605404 MSZ-AY35VGK-E1	U	A0004.9	833,08	2,08
931.0483.50	CLIM.U.I.MUR.COMP.4.2KW 605406 MSZ-AY42VGK-E1	U	A0005.6	969,08	2,08
931.0551.50	CLIM.U.I.MUR.COMP.5.0KW 605408 MSZ-AY50VGK-E1	U	A0006.4	1105,08	2,08



UNITE EXTERIEURE

MXZ-F-VF - Inverter - Standard R32



	DÉSIGNATION	UT	CODE	PPHT (€)	ECOPART (€)
931.1549.49	CLIM.U.E.MULTI 5.4KW 675716 MXZ-3F54VF4-E1	U	405H6.0	3105,66	6,67
931.1840.00	CLIM.U.E.MULTI 6.8KW 675717 MXZ-3F68VF4-E1	U	405J0.1	3686,67	6,67
931.2128.49	CLIM.U.E.SR.M INV.7.2KW 675718 MXZ-4F72VF4-E1	U	406WC.6	4263,65	6,67
931.2372.99	CLIM.U.E.MULTI 8KW 675719 MXZ-4F80VF4-E1	U	405DK.5	4752,66	6,67
931.5651.99	CLIM.U.E.MULTI 10.2KW 674916 MXZ-5F102VF2-E1	U	396TT.0	5658,66	6,67
931.7423.99	CLIM.U.E.SERIE M 12.2KW 404891 MXZ-6F122VF-E1	U	313YV.5	7430,66	6,67
931.0950.49	CLIM.U.E.MULTI 3.3KW 675712 MXZ-2F33VF4-E1	U	404PZ.4	1907,66	6,67
931.1120.50	CLIM.U.E.MULTI 4.2KW 675713 MXZ-2F42VF4-E1	U	A01CA.1	2247,67	6,67
931.1357.49	CLIM.U.E.MULT.INV.5.3KW 675714 MXZ-2F53VF4-E1	U	A01CS.7	2721,66	6,67



UNITE EXTERIEURE

PUMY - Pour installation résidentielle ou collective - PUMY-SP-VKMR



	DÉSIGNATION	UT	CODE	PPHT (€)	ECOPART (€)
579.5369.98	CLIM.U.E.SERIE S M 503781 PUMY-SP112VKMR2.TH	U	303G0.9	5376,65	6,67
579.3113.99	CLIM.U.E.SERIE S M 503784 PUMY-SP125VKMR2.TH	U	303GP.1	6234,65	6,67

CLIMATISEUR GAINABLE



UNITE INTERIEURE GAINABLE

ARXG - KLLA Compact initial et confort - DC Inverter - R32



	DÉSIGNATION	UT	CODE	PPHT (€)	ECOPART (€)
573.0715.49	CLIM.U.I.CONFORT ARXG 9 KLLA.UI 2500W 873141	U	254ED.0	1432,66	1,67
573.0724.00	CLIM.U.I.CONFORT ARXG 12 KLLA.UI 3.5W 873142	U	251NW.0	1449,67	1,67
573.0787.50	CLIM.U.I.CONFORT ARXG 14 KLLA.UI 4.3W 873143	U	254EN.0	1576,67	1,67
573.0866.49	CLIM.U.I.CONFORT ARXG 18 KLLA.UI 5.2W 873144	U	251NX.8	1734,66	1,67

Le PPHT comprend l'ecopart (€)

CLIMATISATION

CLIMATISEUR GAINABLE



UNITE INTERIEURE GAINABLE

ARXG - KMLA / KMLB Initial et confort - DC Inverter - R32



	DÉSIGNATION	UT	CODE	PPHT (€)	ECOPART (€)
573.0836.99	CLIM.U.I.ARXG 22 KMLA.UI R32 6000W 873145	U	228N.9	1675,66	1,67
573.0891.49	CLIM.U.I.CONFORT ARXG 24 KMLB.UI 6W 873213	U	306FG.0	1784,66	1,67
573.0908.49	CLIM.U.I.CONFORT ARXG 24 KMLA.UI 6800W 873146	U	226XR.9	1818,66	1,67
573.0993.00	CLIM.U.I.CONFORT ARXG 30 KMLA.UI 8500W 873147	U	228ML.0	1987,67	1,67
573.1217.50	CLIM.U.I.CONFORT ARXG 36 KMLA.UI 9500W 873148	U	232RS.1	2436,67	1,67



UNITE EXTERIEURE GAINABLE

Fujitsu AOYG - KBTB DC Inverter - Réversible



	DÉSIGNATION	UT	CODE	PPHT (€)	ECOPART (€)
573.1026.99	CLIM.U.E.CONFORT AOYG 9 KBTB.UE 2.5W 872080	U	254EG.3	2060,66	6,67
573.1081.00	CLIM.U.E.CONFORT AOYG 12 KBTB.UE 3.5W 872081	U	254EL.4	2168,67	6,67
573.1236.00	CLIM.U.E.CONFORT AOYG14 KBTB.UE 4.3W 872082	U	248K3.8	2478,67	6,67
573.1316.50	CLIM.U.E.CONFORT AOYG 18 KBTB.UE 5.2W 872083	U	254EQ.6	2639,67	6,67
573.1447.00	CLIM.U.E.CONFORT AOYG 22 KBTB.UE 6W 872084	U	228N3.7	2900,67	6,67
573.1578.50	CLIM.U.E.CONFORT AOYG 24 KBTB.UE 6.8W 872085	U	226XS.7	3163,67	6,67
573.1897.49	CLIM.U.E.CONFORT AOYG 30 KBTB.UE 8.5W 872086	U	228MR.0	3801,66	6,67
573.2268.49	CLIM.U.E.CONFORT AOYG 36 KBTB.UE 9.5W 872087	U	232S1.4	4543,66	6,67



UNITE EXTERIEURE GAINABLE

FUJITSU - AOYG - LALL Carrossable DC Inverter - Réversible



	DÉSIGNATION	UT	CODE	PPHT (€)	ECOPART (€)
573.1123.50	CLIM.U.E.INV.REV.4,3KW AOYG 14 LALL 872114	U	14095.4	2253,67	6,67



GAINABLE

SEZ-MDA/SUZ-MVA-MVAR - Inverter - réversible - Unité intérieure

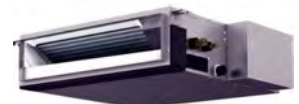

	DÉSIGNATION	UT	CODE	PPHT (€)	ECOPART (€)
931.0568.50	CLIM.U.I.MR SLIM 2.5KW 598619 SEZ-M25DA2.TH	U	353F6.4	1141,17	4,17
931.0600.00	CLIM.U.I.MR SLIM 3.5KW 598642 SEZ-M35DA2.TH	U	353F8.0	1204,17	4,17
931.0676.00	CLIM.U.I.GAL.REV.EXTRA-P. 312209 SEZ-M50DA.TH	U	182BF.1	1356,17	4,17

CLIMATISATION

CLIMATISEUR GAINABLE



Changes for the Better

GAINABLE

SEZ-MDA/SUZ-MVA-MVAR - Inverter - réversible - Groupe extérieur



	DÉSIGNATION	UT	CODE	PPHT (€)	ECOPART (€)
931.0925.49	CLIM.U.E. MR SLIM 3.6KW 493493 SUZ-M35VAR2.TH	U	27168.3	1857,66	6,67
931.0771.50	CLIM.U.E. MR SLIM 2.5KW 493492 SUZ-M25VAR2.TH	U	2716C.4	1549,67	6,67
931.1226.50	CLIM.U.E. MR SLIM 5KW 493494 SUZ-M50VAR2.TH	U	2716E.9	2459,67	6,67
931.1312.49	CLIM.U.E. MR SLIM 6KW 493495 SUZ-M60VAR2.TH	U	2716F.7	2631,66	6,67
931.1322.50	CLIM.U.E. MR SLIM 7.1KW 493496 SUZ-M71VAR1.TH	U	302M8.0	2651,67	6,67



Changes for the Better

GAINABLE

PEAD-SM/M-JA/PUZ Z/M-VKA - Inverter - Unité intérieure - M-JA



	DÉSIGNATION	UT	CODE	PPHT (€)	ECOPART (€)
931.0744.00	CLIM.U.I. MR SLIM 3.6KW 602133 PEAD-M35JA2	U	355GN.3	1492,17	4,17
931.0828.00	CLIM.U.I. MR SLIM 5KW 602135 PEAD-M50JA2	U	343FD.0	1660,17	4,17
931.0871.50	CLIM.U.I. MR SLIM 6.1KW 602137 PEAD-M60JA2	U	355GP.1	1747,17	4,17
931.0880.50	CLIM.U.I. MR SLIM 7.1KW 602138 PEAD-M71JA2	U	344PK.0	1765,17	4,17
931.0981.99	CLIM.U.I. MR SLIM 10KW 602140 PEAD-M100JA2	U	355GR.7	1972,32	8,33
931.1130.50	CLIM.U.I. MR SLIM 12.5KW 602141 PEAD-M125JA2	U	366C7.7	2269,33	8,33
931.1271.49	CLIM.U.I. MR SLIM 13.6KW 602162 PEAD-M140JA2	U	371JR.1	2551,32	8,33



Changes for the Better

GAINABLE

PEAD-SM/M-JA/PUZ Z/M-VKA - Inverter - Groupe extérieur M-VKA



	DÉSIGNATION	UT	CODE	PPHT (€)	ECOPART (€)
931.1983.00	CLIM.U.E. MR SLIM 12KW 336441 PUZ-M125VKA.TH	U	218Z6.3	3972,67	6,67
931.2042.49	CLIM.U.E. MR SLIM 12KW 600117 PUZ-M125VKA2.TH	U	347B6.0	4091,66	6,67



Changes for the Better

GAINABLE

PEAD-SM/M-JA/PUZ Z/M-VKA - Inverter - Groupe extérieur ZM-VKA



	DÉSIGNATION	UT	CODE	PPHT (€)	ECOPART (€)
931.3519.00	CLIM.U.E. MR SLIM 9.5KW 600116 PUZ-M100VKA2.TH	U	355GS.5	3525,67	6,67

CLIMATISATION

CLIMATISEUR MOBILE



ACCESSOIRE

Kit fenêtre - Kit fenêtre



	DÉSIGNATION	UT	CODE	PPHT (€)
020.0026.94	KIT FENETRE MOBILE SHINY 3NGR9008	U	262GV.6	33,68

LIAISON FRIGORIFIQUE



TUBE CUIVRE FRIGO PREISOLE

Bi-tube - Couronne 20 mètres



	DÉSIGNATION	UT	CODE	PPHT (€)
142.0186.38	TUBE CU.PREISOL.BI-TUBE C.20M 1/4X0.8-3/8X0.8	U	246M4.8	248,51



TUBE CUIVRE FRIGO PREISOLE

Bi-tube - Couronne 25 mètres



	DÉSIGNATION	UT	CODE	PPHT (€)
142.0269.66	TUBE CU.PREISOL.BI-TUBE C.25M 1/4X0.8-1/2X0.8	U	246M8.9	359,54
142.0233.20	TUBE CU.PREISOL.BI-TUBE C.25M 1/4X0.8-3/8X0.8	U	246M7.1	310,94
142.0390.64	TUBE CU.PREISOL.BI-TUBE C.25M 1/4X0.8-5/8X1.0	U	246M9.7	520,86
142.0412.04	TUBE CU.PREISOL.BI-TUBE C.25M 3/8X0.8-5/8X1.0	U	246MA.4	549,38



TUBE CUIVRE FRIGO PREISOLE M1

Bitube - Couronne 50 mètres



	DÉSIGNATION	UT	CODE	PPHT (€)
999.0597.36	TUBE CU.PREISOL.BI-TUBE C.50M 1/4X0.8-3/8X0.8	U	245ZP.1	597,36

RACCORDS FRIGORIFIQUE A BRASER

Conex | Bänninger

COURBE B ACR A SOUDER

90° - FF - Grand Rayon - 9607LT



	DÉSIGNATION	UT	CODE	PPHT (€)
380.0003.64	COURBE 90 GR SOUD.FF ACR 3/8 9607D003000000	U	225UT.0	3,64

Le PPHT comprend l'ecopart (€)

CLIMATISATION

RACCORDS FRIGORIFIQUE A BRASER

Conex | Bänninger

COURBE B ACR A SOUDER
90° - FF - Grand Rayon - 9607LT
- suite



	DÉSIGNATION	UT	CODE	PPHT (€)
380.0004.33	COURBE 90 GR SOUD.FF ACR 1/2 9607D004000000	U	225UV.5	4,33
380.0007.17	COURBE 90 GR SOUD.FF ACR 5/8 9607D005000000	U	225UW.3	7,17
380.0008.87	COURBE 90 GR SOUD.FF ACR 3/4 9607D006000000	U	225UX.1	8,87
380.0011.37	COURBE 90 GR SOUD.FF ACR 7/8 9607D007000000	U	225UY.9	11,37
380.0023.16	COURBE 90 GR SOUD.FF ACR 1 9607D008000000	U	225UZ.8	23,16
380.0019.18	COURBE 90 GR SOUD.FF ACR 11/8 9607D009000000	U	225V0.7	19,18
380.0028.44	COURBE 90 GR SOUD.FF ACR 13/8 9607D011000000	U	225V1.5	28,44

Conex | Bänninger

COURBE B ACR A SOUDER
90° - MF - Grand Rayon - 9607-2LT



	DÉSIGNATION	UT	CODE	PPHT (€)
380.0003.05	COURBE 90 GR SOUD.MF ACR 3/8 9607E003000000	U	225V3.1	3,05
380.0004.94	COURBE 90 GR SOUD.MF ACR 1/2 9607E004000000	U	225V4.9	4,94
380.0008.09	COURBE 90 GR SOUD.MF ACR 5/8 9607E005000000	U	225V5.6	8,09
380.0009.32	COURBE 90 GR SOUD.MF ACR 3/4 9607E006000000	U	225V6.4	9,32
380.0009.87	COURBE 90 GR SOUD.MF ACR 7/8 9607E007000000	U	225V7.2	9,87
380.0023.95	COURBE 90 GR SOUD.MF ACR 11/8 9607E009000000	U	225V8.0	23,95

Conex | Bänninger

COUDE B ACR A SOUDER
45° - FF - 9606



	DÉSIGNATION	UT	CODE	PPHT (€)
380.0006.55	COUDE 45 A SOUD.FF ACR 3/8 9606 003000000	U	225TP.9	6,55
380.0003.76	COUDE 45 A SOUD.FF ACR 1/2 9606 004000000	U	225TQ.7	3,76
380.0003.29	COUDE 45 A SOUD.FF ACR 5/8 9606 005000000	U	225TU.8	3,29
380.0007.11	COUDE 45 A SOUD.FF ACR 3/4 9606 006000000	U	225TW.4	7,11
380.0007.29	COUDE 45 A SOUD.FF ACR 7/8 9606 007000000	U	225TX.2	7,29
380.0014.97	COUDE 45 A SOUD.FF ACR 1" 9606 008000000	U	225TZ.9	14,97
380.0013.71	COUDE 45 A SOUD.FF ACR 1"1/8 9606 009000000	U	225U0.8	13,71
380.0019.72	COUDE 45 A SOUD.FF ACR 1"3/8 9606 011000000	U	225U3.2	19,72

Conex | Bänninger

MANCHON B ACR A SOUDER
FF - 9600



	DÉSIGNATION	UT	CODE	PPHT (€)
380.0001.38	MANCHON A SOUD.FF ACR 1/4 9600 002000000	U	225S3.4	1,38
380.0002.76	MANCHON A SOUD.FF ACR 3/8 9600 003000000	U	225S5.9	2,76
380.0001.56	MANCHON A SOUD.FF ACR 1/2 9600 004000000	U	225S6.7	1,56
380.0006.04	MANCHON A SOUD.FF ACR 3/4 9600 006000000	U	225S9.1	6,04
380.0005.26	MANCHON A SOUD.FF ACR 7/8 9600 007000000	U	225SA.8	5,26
380.0013.67	MANCHON A SOUD.FF ACR 1" 9600 008000000	U	225SB.6	13,67

CLIMATISATION

RACCORDS FRIGORIFIQUE A BRASER

Conex | Bänninger

MANCHON B ACR A SOUDER
FF - 9600
- suite



	DÉSIGNATION	UT	CODE	PPHT (€)
380.0009.60	MANCHON A SOUD.FF ACR 1"1/8 9600 009000000	U	225SC.4	9,60
380.0011.18	MANCHON A SOUD.FF ACR 1"3/8 9600 011000000	U	225SD.2	11,18

Conex | Bänninger

MANCHON B ACR A SOUDER
Reduit - FF - 9600R



	DÉSIGNATION	UT	CODE	PPHT (€)
380.0003.59	MANCHON R.SOUD.FF ACR 3/8-1/4 9600 003002000	U	225SG.5	3,59
380.0005.55	MANCHON R.SOUD.FF ACR 1/2-1/4 9600 004002000	U	225SH.3	5,55
380.0003.03	MANCHON R.SOUD.FF ACR 1/2-3/8 9600 004003000	U	225SJ.0	3,03
380.0003.85	MANCHON R.SOUD.FF ACR 5/8-3/8 9600 005003000	U	225SK.8	3,85
380.0003.65	MANCHON R.SOUD.FF ACR 5/8-1/2 9600 005004000	U	225SL.6	3,65
380.0009.02	MANCHON R.SOUD.FF ACR 7/8-5/8 9600 007005000	U	225ST.2	9,02

Conex | Bänninger

MANCHON B ACR A SOUDER
Reduit - MF - 9600-2



	DÉSIGNATION	UT	CODE	PPHT (€)
380.0003.72	MANCHON R.SOUD.MF ACR 3/8-1/4 9600A003002000	U	225T1.7	3,72
380.0005.16	MANCHON R.SOUD.MF ACR 1/2-1/4 9600A004002000	U	225T4.1	5,16
380.0003.59	MANCHON R.SOUD.MF ACR 1/2-3/8 9600A004003000	U	225T5.8	3,59
380.0004.50	MANCHON R.SOUD.MF ACR 5/8-3/8 9600A005003000	U	225T6.6	4,50
380.0003.51	MANCHON R.SOUD.MF ACR 5/8-1/2 9600A005004000	U	225T7.4	3,51
380.0004.56	MANCHON R.SOUD.MF ACR 3/4-5/8 9600A006005000	U	225TA.7	4,56
380.0005.00	MANCHON R.SOUD.MF ACR 7/8-5/8 9600A007005000	U	225TC.3	5,00
380.0006.56	MANCHON R.SOUD.MF ACR 7/8-3/4 9600A007006000	U	225TD.1	6,56
380.0009.05	MANCHON R.SOUD.MF ACR 11/8-5/8 9600A009005000	U	225TE.8	9,05
380.0008.21	MANCHON R.SOUD.MF ACR 11/8-7/8 9600A009007000	U	225TH.2	8,21
380.0012.27	MANCHON R.SOUD.MF ACR 13/8-11/8 9600A011009000	U	225TK.7	12,27

Conex | Bänninger

TE B ACR A SOUDER
Egal- FFF - 9611



	DÉSIGNATION	UT	CODE	PPHT (€)
380.0008.72	TE EGAL A SOUD.FFF ACR 1/4 9611 002002002	U	225VB.3	8,72
380.0006.45	TE EGAL A SOUD.FFF ACR 3/8 9611 003003003	U	225VC.1	6,45
380.0007.04	TE EGAL A SOUD.FFF ACR 1/2 9611 004004004	U	225VD.9	7,04
380.0004.80	TE EGAL A SOUD.FFF ACR 5/8 9611 005005005	U	225VE.6	4,80
380.0010.97	TE EGAL A SOUD.FFF ACR 7/8 9611 007007007	U	225VG.2	10,97
380.0022.02	TE EGAL A SOUD.FFF ACR 11/8 9611 009009009	U	225VK.5	22,02
380.0038.63	TE EGAL A SOUD.FFF ACR 13/8 9611 011011011	U	225VL.3	38,63

CLIMATISATION

RACCORDS FRIGORIFIQUE A SERTIR

Conex | Bänninger

ACCESSOIRES B MAXIPRO

Jauge profondeur



	DÉSIGNATION	UT	CODE	PPHT (€)
379.0014.59	JAUGE DE PROFONDEUR MAXIPRO MPA DEPTH GAUGE	U	240MW.4	20,84

Conex | Bänninger

COUDE B MAXIPRO A SERTIR

45° - FF - MPA5041



	DÉSIGNATION	UT	CODE	PPHT (€)
379.0015.04	COUDE 45 FF D.3/8 MAXIPRO MPA5041 0030001	U	239C9.2	21,49
379.0017.44	COUDE 45 FF D.1/2 MAXIPRO MPA5041 0040001	U	239CB.7	24,92
379.0019.25	COUDE 45 FF D.5/8 MAXIPRO MPA5041 0050001	U	239CC.5	27,50
379.0023.46	COUDE 45 FF D.3/4 MAXIPRO MPA5041 0060001	U	239CE.0	33,52
379.0027.08	COUDE 45 FF D.1" MAXIPRO MPA5041 0080001	U	239CG.6	38,68
379.0028.88	COUDE 45 FF D.1"1/8 MAXIPRO MPA5041 0090001	U	239CH.4	41,26
379.0024.67	COUDE 45 FF D.7/8 MAXIPRO MPA5041 0070001	U	239CF.8	35,24

Conex | Bänninger

COUDE B MAXIPRO A SERTIR

90° - FF - MPA5002



	DÉSIGNATION	UT	CODE	PPHT (€)
379.0018.65	COUDE 90 FF D1/4 MAXIPRO MPA5002 0020001	U	240L8.3	26,64
379.0019.25	COUDE 90 FF D3/8 MAXIPRO MPA5002 0030001	U	239A5.2	27,50
379.0020.45	COUDE 90 FF D1/2 MAXIPRO MPA5002 0040001	U	239A6.0	29,22
379.0022.56	COUDE 90 FF D5/8 MAXIPRO MPA5002 0050001	U	239A8.6	32,23
379.0024.97	COUDE 90 FF D3/4 MAXIPRO MPA5002 0060001	U	239A9.4	35,67
379.0025.87	COUDE 90 FF D7/8 MAXIPRO MPA5002 0070001	U	239AA.1	36,96
379.0027.68	COUDE 90 FF D1" MAXIPRO MPA5002 0080001	U	240LE.9	39,54
379.0031.28	COUDE 90 FF D1"1/8 MAXIPRO MPA5002 0090001	U	239AC.7	44,69

Conex | Bänninger

COUDE B MAXIPRO A SERTIR

90° - MF - MPA5001



	DÉSIGNATION	UT	CODE	PPHT (€)
379.0015.04	COUDE 90 MF D3/8 MAXIPRO MPA5001 0030001	U	240LF.7	21,49
379.0016.24	COUDE 90 MF D1/2 MAXIPRO MPA5001 0040001	U	239AD.5	23,20
379.0018.05	COUDE 90 MF D5/8 MAXIPRO MPA5001 0050001	U	239AE.2	25,78

Conex | Bänninger

MANCHON B MAXIPRO A SERTIR

FF - MPA5270



	DÉSIGNATION	UT	CODE	PPHT (€)
379.0013.24	MANCHON FF D1/4 MAXIPRO MPA5270 0020001	U	239Z5.9	18,91

CLIMATISATION

RACCORDS FRIGORIFIQUE A SERTIR

Conex | Bänninger

MANCHON B MAXIPRO A SERTIR

FF - MPA5270

- suite



	DÉSIGNATION	UT	CODE	PPHT (€)
379.0014.44	MANCHON FF D3/8 MAXIPRO MPA5270 0030001	U	239Z6.6	20,63
379.0014.44	MANCHON FF D1/2 MAXIPRO MPA5270 0040001	U	239Z7.5	20,63
379.0015.04	MANCHON FF D5/8 MAXIPRO MPA5270 0050001	U	239A0.3	21,49
379.0016.24	MANCHON FF D3/4 MAXIPRO MPA5270 0060001	U	239A1.1	23,20
379.0017.75	MANCHON FF D7/8 MAXIPRO MPA5270 0070001	U	239A2.9	25,35
379.0019.25	MANCHON FF D1" MAXIPRO MPA5270 0080001	U	239A3.7	27,50
379.0021.66	MANCHON FF D1"1/8 MAXIPRO MPA5270 0090001	U	239A4.5	30,94

Conex | Bänninger

MANCHON B MAXIPRO A SERTIR

Réduit - FF - MPA5240



	DÉSIGNATION	UT	CODE	PPHT (€)
379.0025.87	MANCHON RED.FF1/2-3/8 MAXIPRO MPA5240 0040301	U	239B6.9	36,96
379.0026.47	MANCHON RED.FF5/8-3/8 MAXIPRO MPA5240 0050301	U	239BA.0	37,82
379.0027.68	MANCHON RED.FF5/8-1/2 MAXIPRO MPA5240 0050401	U	239BB.8	39,54
379.0026.75	MANCHON RED.FF3/4-1/2 MAXIPRO MPA5240 0060401	U	239BE.1	38,22
379.0027.98	MANCHON RED.FF3/4-5/8 MAXIPRO MPA5240 0060501	U	239BF.9	39,97
379.0031.89	MANCHON RED.FF7/8-5/8 MAXIPRO MPA5240 0070501	U	239BG.7	45,55
379.0033.69	MANCHON RED.FF7/8-3/4 MAXIPRO MPA5240 0070601	U	239BH.5	48,13
379.0019.94	MANCHON RE.FF3/8-1/4 MAXIPRO MPA5240 0030201	U	251XN.3	28,49

Conex | Bänninger

MANCHON B MAXIPRO A SERTIR

Réduit - MF - MPA5243



	DÉSIGNATION	UT	CODE	PPHT (€)
379.0016.24	MANCHON RED.MF3/8-1/4 MAXIPRO MPA5243 0030201	U	239BR.8	23,20
379.0015.64	MANCHON RED.MF1/2-3/8 MAXIPRO MPA5243 0040301	U	239BS.6	22,34
379.0014.74	MANCHON RED.MF5/8-3/8 MAXIPRO MPA5243 0050301	U	239BU.1	21,06
379.0014.74	MANCHON RED.MF5/8-1/2 MAXIPRO MPA5243 0050401	U	239BW.7	21,06
379.0021.66	MANCHON RED.MF3/4-5/8 MAXIPRO MPA5243 0060501	U	239BZ.2	30,94
379.0017.44	MANCHON RED.MF7/8-5/8 MAXIPRO MPA5243 0070501	U	239C0.1	24,92
379.0018.05	MANCHON RED.MF7/8-3/4 MAXIPRO MPA5243 0070601	U	239C2.7	25,78

Conex | Bänninger

MANCHON B MAXIPRO A SERTIR

Long - FF - MPA5240L - Réduit



	DÉSIGNATION	UT	CODE	PPHT (€)
379.0028.50	MANCHON LONG RED.FF 3/8-1/4 MPA5240L0030201	U	241GM.7	28,50
379.0038.81	MANCHON LONG RED.FF 1"-5/8 MPA5240L0080501	U	241GP.3	55,44

CLIMATISATION

RACCORDS FRIGORIFIQUE A SERTIR

Conex | Bänninger

MANCHON B MAXIPRO A SERTIR

Long de Réparation - FF - MPA5275L



	DÉSIGNATION	UT	CODE	PPHT (€)
379.0021.45	MANCHON REP FF 3/8 MAXIPRO MPA5275L0030001	U	240M4.1	30,64
379.0016.43	MANCHON REP FF 1/2 MAXIPRO MPA5275L0040001	U	240M5.8	23,47
379.0020.22	MANCHON REP FF 5/8 MAXIPRO MPA5275L0050001	U	240M6.6	28,89
379.0022.32	MANCHON REP FF 3/4 MAXIPRO MPA5275L0060001	U	240M7.4	31,88

Conex | Bänninger

TE B MAXIPRO A SERTIR

Egal - FFF - MPA5T



	DÉSIGNATION	UT	CODE	PPHT (€)
379.0027.68	TE EGAL FFF D1/4 MAXIPRO MPA5T 002020201	U	239AJ.3	39,54
379.0029.48	TE EGAL FFF D3/8 MAXIPRO MPA5T 003030301	U	239AM.7	42,12
379.0031.28	TE EGAL FFF D1/2 MAXIPRO MPA5T 004040401	U	239AN.5	44,69
379.0033.69	TE EGAL FFF D5/8 MAXIPRO MPA5T 005050501	U	239AP.3	48,13
379.0036.10	TE EGAL FFF D3/4 MAXIPRO MPA5T 006060601	U	239AR.9	51,57
379.0037.91	TE EGAL FFF D7/8 MAXIPRO MPA5T 007070701	U	239AS.7	54,15

Conex | Bänninger

RACCORD B MAXIPRO A SERTIR

Flare spl - MPA5286G - Femelle



	DÉSIGNATION	UT	CODE	PPHT (€)
379.0019.53	RACCORD FLARE F1/4 MAXIPRO MPA5286G0020201	U	240ME.8	27,90
379.0025.97	RACCORD FLARE F3/8 MAXIPRO MPA5286G0030301	U	240MF.6	37,10
379.0032.35	RACCORD FLARE F1/2 MAXIPRO MPA5286G0040401	U	240MG.4	46,22
379.0038.18	RACCORD FLARE F5/8 MAXIPRO MPA5286G0050501	U	240MH.2	54,54
379.0049.90	RACCORD FLARE F3/4 MAXIPRO MPA5286G0060601	U	240MJ.9	71,28

REGULATION

AIRZONE

PACK THERMOSTAT CONNECTE

BLUEZERO filaire



	DÉSIGNATION	UT	CODE	PPHT (€)
562.0844.57	PACK THERMO BLUEZERO BLC + CABLE -4- PTB8F4B	U	317ZP.8	1689,15

CLIMATISATION

REGULATION

AIRZONE

PACK THERMOSTAT CONNECTE

BLUEZERO Think



	DÉSIGNATION	UT	CODE	PPHT (€)
562.1028.67	PACK THERMOST.1 BLUEZERO +4 THINK BLC PTBTR5B	U	243B2.0	2057,34

AIRZONE

PACK THERMOSTAT CONNECTE

BLUEZERO Think - Avec Webserveur Cloud Wifi



	DÉSIGNATION	UT	CODE	PPHT (€)
562.0833.15	PACK THERMOST.1BLUEZ+2THINK BLC+WEB PTBTR3BW	U	266XW.4	1666,31
562.1267.29	PACK THERMOST.1BLUEZ+4THINK BLC+WEB PTBTR5BW	U	266XY.0	2534,58
562.1050.23	PACK THERMOST.1BLUEZ+3THINK BLC+WEB PTBTR4BW	U	266XX.2	2100,47

AIRZONE

PACK THERMOSTAT CONNECTE

BLUEFACE Think - Avec Webserveur Cloud Wifi



	DÉSIGNATION	UT	CODE	PPHT (€)
562.2105.72	PACK THERMO THINK RAD.BLC+WEBSERVER PTTR4BW	U	266W2.6	2105,72
562.2539.88	PACK THERMO THINK RAD.BLC+WEBSERVER PTTR5BW	U	266W8.3	2539,88

AIRZONE

SYSTEME ELECTRONIQUE

Serveur Web



	DÉSIGNATION	UT	CODE	PPHT (€)
562.0254.45	WEBSERVER HUB CLOUD ETHERNET WIFI AZX6WSPHUB	U	333MW.7	508,90

AIRZONE

THERMOSTAT

IB Pro BLUEFACE filaire



	DÉSIGNATION	UT	CODE	PPHT (€)
562.0225.99	THERMOSTAT IBPRO6 BLUEFACE BL AZCE6BLUEZEROCB	U	337D4.4	451,98

AIRZONE

THERMOSTAT

IBPRO6 Think Radio blanc - Monochrome blanc



	DÉSIGNATION	UT	CODE	PPHT (€)
562.0460.35	THERMOSTAT IBPRO6 THINK RAD.BLC AZCE6THINKRB	U	342E1.9	460,35

CLIMATISATION

REGULATION

atlantic

TELECOMMANDE
Commande - Filaire



	DÉSIGNATION	UT	CODE	PPHT (€)	ECOPART (€)
572.0207.00	TELECOMMANDE FILAIRE VRF UTU-RLRY 876138	U	6045Y.5	207,12	0,12

DAIKIN

TELECOMMANDE
MADOKA Câblée - Filaire



	DÉSIGNATION	UT	CODE	PPHT (€)
575.0194.40	TELECOMMANDE MADOKA FILAIRE BLANCHE BRC1H52W	U	277J0.4	243,00

DAIKIN

INTERFACE
Carte/Interface Wifi



	DÉSIGNATION	UT	CODE	PPHT (€)
575.0063.25	CARTE LAN.ALT PILOTAGE SMARTPHONE BRP069B45	U	169WL.2	115,00

MITSUBISHI ELECTRIC
Changes for the Better
COMMANDE/TELECOMMANDE
Support télécommande



	DÉSIGNATION	UT	CODE	PPHT (€)
931.0015.00	SUPPORT TEL.SF/AP/EF/LN 491846 MAC-1300RC-E	U	300LH.5	15,00

MITSUBISHI ELECTRIC
Changes for the Better
INTERFACE
WIFI



	DÉSIGNATION	UT	CODE	PPHT (€)
931.0146.00	INTERFACE WIFI 601928 MAC-587IF-E	U	357BF.9	146,00

MITSUBISHI ELECTRIC
Changes for the Better
TELECOMMANDE
Filaire - Mr Slim



	DÉSIGNATION	UT	CODE	PPHT (€)	ECOPART (€)
931.0281.00	TELECOMMANDE FIL. 606129 PAR-41MAA MR. SLIM	U	359PE.9	281,06	0,06

CLIMATISATION

REGULATION

MITSUBISHI ELECTRIC
Changes for the Better
TELECOMMANDE

Tactile Bluetooth - Pour UI City Multi



	DÉSIGNATION	UT	CODE	PPHT (€)	ECOPART (€)
579.0165.00	TELECOMMANDE TACT.BT BL 315706 PAR-CT01MAA-SB	U	239R7.7	165,06	0,06

CONDENSATS

ASPEN PUMPS

POMPE DE RELEVAGE

Mini Aqua - Marché résidentiel - 230 V - 16 W



	DÉSIGNATION	UT	CODE	PPHT (€)
000.0117.30	POMPE MINI BLEUE AQUA FP2406/2	U	216VE.5	156,40

ASPEN PUMPS

POMPE DE RELEVAGE

Mini orange



	DÉSIGNATION	UT	CODE	PPHT (€)
000.0072.34	POMPE MINI ORANGE FP2212	U	240G2.1	96,46

ASPEN PUMPS

POMPE DE RELEVAGE

Mini blanche - Silence +



	DÉSIGNATION	UT	CODE	PPHT (€)
999.0116.48	POMPE MINI SILENT+ BLANCHE FP3450	U	A06NO.1	116,48

ASPEN PUMPS

POMPE DE RELEVAGE

Mini verte - Silence + - Artiplastic



	DÉSIGNATION	UT	CODE	PPHT (€)
999.0142.71	POMPE MINI VERTE SILENCE+ ARTIP.BLC FP3314/3	U	A070A.1	142,71

Le PPHT comprend l'ecopart (€)

CLIMATISATION

CONDENSATS



POMPE DE RELEVAGE

Mini verte - Silence + - Optimal



	DÉSIGNATION	UT	CODE	PPHT (€)
000.0142.71	POMPE MINI VERTE SILENCE+ OPTIMAL FP3327/3	U	411ZE.8	142,71



POMPE DE RELEVAGE

Mini verte - Silence + - Pompe seule



	DÉSIGNATION	UT	CODE	PPHT (€)
000.0075.13	POMPE MINI VERTE EOM SILENC E+EOM FP3322/3	U	372JZ.3	100,17



POMPE AVEC BAC

Pompe mini tank - 230V - 16W



	DÉSIGNATION	UT	CODE	PPHT (€)
000.0103.39	POMPE MINI TANK 35L/H FP1056/2	U	26715.3	137,85



ACCESSOIRES DE CONDENSATS

Bac à condensats - Plastique - Avec support mural



	DÉSIGNATION	UT	CODE	PPHT (€)
000.0024.34	BAC A CONDENSAT PETIT MODEL 790X390X30 B3385	U	A000W.3	30,43



ACCESSOIRES DE CONDENSATS

Coude 90 pvc rigide



	DÉSIGNATION	UT	CODE	PPHT (€)
000.0001.48	COUDE 90 PVC RIGIDE 20MM B3302	U	A000Z.8	1,98

CLIMATISATION

CONDENSATS



ACCESSOIRES DE CONDENSATS

Adaptateur - Tuyau souple au tuyau de trop-plein/ de vidange/renvoi - Sachet de 3



	DÉSIGNATION	UT	CODE	PPHT (€)
000.0008.20	ADAPTATEUR RIGIDE 21MM XTRA -3- FP2040	U	240JS.6	10,94
000.0020.16	ADAPTATEUR AUTO ETANCHE -3- FP2038	U	240J9.3	26,88



ACCESSOIRES DE CONDENSATS

Té cannelé - Union cannelé - Droit - Cannelé



	DÉSIGNATION	UT	CODE	PPHT (€)
000.0004.02	RACCORD P/TUBE SOUPLE 6MM -5- FP2622	U	240J8.5	5,36



ACCESSOIRES DE CONDENSATS

Té cannelé - Union cannelé - Pour tube souple



	DÉSIGNATION	UT	CODE	PPHT (€)
000.0004.62	RACCORD COUDE P/TUBE SOUPLE 6MM -5- FP2028	U	240JN.4	6,16



ACCESSOIRES DE CONDENSATS

Té cannelé - Union cannelé



	DÉSIGNATION	UT	CODE	PPHT (€)
000.0001.10	TE CANNELE 16MM 209DV00018	U	240HU.3	1,47
000.0000.89	UNION CANNELE 16MM 209DV00020	U	240HW.9	1,19



ACCESSOIRES DE CONDENSATS

Réduction "magique" - Souple/Rigide - Ivoire



	DÉSIGNATION	UT	CODE	PPHT (€)
000.0004.67	REDUCTION MAGIQUE D32MM IVOIRE 175ACL0168	U	186FM.5	4,67

CLIMATISATION

CONDENSATS



ACCESSOIRES DE CONDENSATS

Raccord Y - Pour tube d'évacuation des condensats avec joints - Nylon



	DÉSIGNATION	UT	CODE	PPHT (€)
000.0001.18	CONNEXION Y CANNELE 16MM NYLON 209DV00017	U	240HM.8	1,58



TUBE DE CONDENSATS

Tube annelé



	DÉSIGNATION	UT	CODE	PPHT (€)
000.0031.17	TUBE ANNELE 16-18-20MM 50M B6018	U	A02WU.6	38,96



TUBE DE CONDENSATS

Tube d'évacuation des condensats - Tube cristal



	DÉSIGNATION	UT	CODE	PPHT (€)
000.0020.80	TUBE XTRA CLAIR 10X14 - COURONNE 25M- AX5213	U	240J7.7	27,74
000.0014.00	TUBE XTRA CLAIR 6X9 - COURONNE 50M- AX5211/1	U	240JB.8	18,67



TUBE DE CONDENSATS

Tube d'évacuation des condensats - Semi-rigide - Clair armé semi-rigide



	DÉSIGNATION	UT	CODE	PPHT (€)
000.0054.35	TUBE EXTRA SEMI RIG. 16X22 - COUR.25M- AX5122	U	240J6.9	72,47
999.0024.90	TUBE EXTRA SEMI RIG. 6X12 - COUR.25M- AX5120	U	274RT.1	24,90



TUBE DE CONDENSATS

Tube d'évacuation des condensats - PVC - Lisse - à l'intérieur



	DÉSIGNATION	UT	CODE	PPHT (€)
000.0027.86	TUBE PVC LISSE D16 EVAC.COND. 50M 175ACL0098	U	2062C.5	37,14

CLIMATISATION

CONDENSATS



BOUCHON

Bouchons de condensats - PEA(D)-RP



	DÉSIGNATION	UT	CODE	PPHT (€)
931.0051.00	BOUCHON CONDENSATS U.E. 152046 PAC-SG61DSE	U	0687J.0	51,00



POMPE DE RELEVAGE

SI - Pompe centrifuge monobloc - SI 1830



	DÉSIGNATION	UT	CODE	PPHT (€)	ECOPART (€)
562.0230.49	POMPE A BAC SI 1830 0.5L 400L/H SI1830SCUN23	U	243ME.2	230,91	0,42



POMPE DE RELEVAGE

SI - Pompe avec bac - SI 2052



	DÉSIGNATION	UT	CODE	PPHT (€)	ECOPART (€)
562.0116.34	POMPE A CASSETTE SI 2052 SI2052SIUN23	U	231CF.5	145,85	0,42



POMPE DE RELEVAGE

SI - Pompe avec bac - SI-83 - Pack 2



	DÉSIGNATION	UT	CODE	PPHT (€)	ECOPART (€)
562.0203.06	POMPE A BAC SI-83 2L 500L/H PCK2 SI83CE42UN23	U	243MA.1	203,48	0,42



POMPE DE RELEVAGE

SI - Mini pompe - SI-20



	DÉSIGNATION	UT	CODE	PPHT (€)
562.0192.72	POMPE BI-BLOC SI-20 SI20CE02UN23	U	A00TA.2	256,96



POMPE DE RELEVAGE

SI - Mini pompe - SI-30



	DÉSIGNATION	UT	CODE	PPHT (€)	ECOPART (€)
562.0125.75	POMPE BI-BLOC SI-30 SI30CE01UN23	U	6970U.2	251,93	0,42

Le PPHT comprend l'ecopart (€)

CLIMATISATION

CONDENSATS

sauermann

POMPE DE RELEVAGE

SI - Mini pompe - SI-33



DÉSIGNATION	UT	CODE	PPHT (€)	ECOPART (€)
562.0282.66 POMPE BI-BLOC SI-33 30L/H SI33CE01UN23	U	8212Y.8	283,08	0,42

sauermann

POMPE DE RELEVAGE

SI - Mini pompe - SI-60



DÉSIGNATION	UT	CODE	PPHT (€)	ECOPART (€)
562.0290.88 POMPE A BAC SI-60 0.37L 20L/H SI60CE01UN23	U	2380X.8	291,30	0,42

sauermann

POMPE DE RELEVAGE

PE - Pompe péristaltique - Compacte - Pour applications jusqu'à 8 kW - PE 5100 - Monophasée



DÉSIGNATION	UT	CODE	PPHT (€)	ECOPART (€)
562.0298.57 POMPE PERISTALTIQUE PE5100 PE5100SIUN23	U	49354.4	373,63	0,42

sauermann

POMPE DE RELEVAGE

Delta Pack - Delta Fix - Ensemble prêt à poser - Monophasée - Pour climatiseurs muraux



DÉSIGNATION	UT	CODE	PPHT (€)	ECOPART (€)
562.0124.43 POMPE DELTA PACK 80X60+KIT BLANC DP10CE05UN23	U	215UA.7	249,29	0,42
562.0248.87 POMPE DELTA PACK 80X60+KIT IVOIR DP10CE06UN23	U	210RQ.1	249,29	0,42

sauermann

ACCESSOIRE DE CONDENSAT

Collier de serrage - Pour tube PVC tressé - Double fil



DÉSIGNATION	UT	CODE	PPHT (€)
562.0048.19 COLLIER SERRAGE D6MM 1/4" ACC00916	U	245JG.6	48,19

sauermann

ACCESSOIRE DE CONDENSAT

Connecteur - Coudé



DÉSIGNATION	UT	CODE	PPHT (€)
562.0004.85 CONNECTEUR COUDE D6MM ACC00904	U	231F4.7	9,70

Le PPHT comprend l'ecopart (€)

CLIMATISATION

CONDENSATS

sauermann

ACCESSOIRE DE CONDENSAT

Connecteur - Droit



DÉSIGNATION	UT	CODE	PPHT (€)
562.0004.21 CONNECTEUR RIGIDE DROIT D6MM 1/4" ACC00900	U	245JB.7	8,41

sauermann

ACCESSOIRE DE CONDENSAT

Tube de recharge péristaltique



DÉSIGNATION	UT	CODE	PPHT (€)
562.0029.06 TUBE DE RECHANGE P.POMPE PE5002	U	40511.1	29,06

GOULOTTE

ARTIPLASTIC

GOULOTTE

Avec film plastique



DÉSIGNATION	UT	CODE	PPHT (€)
562.0013.83 GOULOTTE T.06 60X45 2ML BLANC 0612BCF-W	U	A02E0.9	13,83
562.0013.83 GOULOTTE T.06 60X45 2ML IVOIR.TUB.C16 0612BCF	U	A02CM.5	13,83
562.0010.36 GOULOTTE T.08 80X60 2ML BLANC 0812BCF-W	U	229M5.1	20,72
562.0010.36 GOULOTTE T.08 80X60 2ML IVOIRE 0812BCF	U	247UD.4	20,72
562.0014.83 GOULOTTE T.12 110X75 2ML BLANC 1212BCF-W	U	229M6.9	29,67
562.0014.83 GOULOTTE T.12 110X75 2ML IVOIRE 1212BCF	U	247UE.1	29,67
562.0045.26 GOULOTTE T.14 90X140 2ML IVOIRE 1412BCF	U	265FK.1	45,26

ARTIPLASTIC

GOULOTTE

Standard



DÉSIGNATION	UT	CODE	PPHT (€)
562.0004.36 GOULOTTE T.3 25X25 2ML IVOIRE TUB. 0312BC	U	3640E.9	5,45

ARTIPLASTIC

ACCESSOIRES

Angle - Apparent



DÉSIGNATION	UT	CODE	PPHT (€)
562.0000.79 ANGLE APPARENT T.03 25X25 IVOIRE 0307CP	U	3640A.8	1,58
562.0004.87 ANGLE APPARENT T.06 60X45 BLANC 0607CP-W	U	A02EE.8	4,87
562.0004.87 ANGLE APPARENT T.06 60X45 IVOIRE 0607CP	U	A02CS.5	4,87
562.0003.17 ANGLE APPARENT T.08 80X60 BLANC 0807CP-W	U	229MB.8	6,35
562.0003.17 ANGLE APPARENT T.08 80X60 IVOIRE 0807CP	U	3639H.6	6,35
562.0004.63 ANGLE APPARENT T.12 110X75 IVOIRE 1207CP	U	3639I.4	9,27
562.0009.27 ANGLE APPARENT T.12 110X75 BLANC 1207CP-W	U	229MC.6	9,27
999.0012.98 ANGLE APPARENT T14 140X90 IVOIRE 1407CP	U	288B6.6	12,98

CLIMATISATION

GOULOTTE



ACCESSOIRES

Angle - Apparent réglable



	DÉSIGNATION	UT	CODE	PPHT (€)
562.0005.30	ANGLE APPARENT REGL.T.06 60X45 BLANC 0620IR-W	U	A02ED.1	5,30
562.0005.77	ANGLE APPARENT REGL.T.06 60X45 IVOIRE 0622PR	U	A02CZ.1	5,77
562.0007.94	ANGLE APPARENT REGL.T.08 80X60 BLC 0822PR-W	U	238L7.9	7,94
562.0007.94	ANGLE APPARENT REGL.T.08 80X60 IVOIRE 0822PR	U	0493S.8	7,94
562.0010.75	ANGLE APPARENT REG.IVOIRE ARTIPL. 1222PR	U	0493T.6	10,75
562.0010.75	ANGLE APPARENT REG.BLANC ARTIPL. 1222PR-W	U	288BF.6	10,75



ACCESSOIRES

Angle - Extérieur



	DÉSIGNATION	UT	CODE	PPHT (€)
562.0000.79	ANGLE EXTERIEUR T.03 25X25 IVOIRE 0306AE	U	3640C.4	1,58
562.0004.29	ANGLE EXTERIEUR T.06 60X45 BLANC 0606AE-W	U	A02E6.6	4,29
562.0004.29	ANGLE EXTERIEUR T.06 60X45 IVOIRE 0606AE	U	05172.2	4,29
562.0002.46	ANGLE EXTERIEUR T.08 80X60 BLANC 0806AE-W	U	229M9.3	4,92
562.0002.46	ANGLE EXTERIEUR T.08 80X60 IVOIRE 0806AE	U	3639D.5	4,92
562.0003.23	ANGLE EXTERIEUR T.12 110X75 IVOIRE 1206AE	U	3639E.2	6,46
562.0006.46	ANGLE EXTERIEUR T12 110X75 BLANC 1206AE-W	U	229MA.0	6,46
562.0008.42	ANGLE EXTERIEUR T14 140X90 IVOIRE 1406AE	U	288B5.8	8,42



ACCESSOIRES

Angle - Extérieur réglable



	DÉSIGNATION	UT	CODE	PPHT (€)
562.0005.30	ANGLE EXTERIEUR REGL.T.06 60X45 BLC 0621ER-W	U	A02E9.0	5,30
562.0005.30	ANGLE EXTERIEUR REGL.T.06 60X45 IVOIRE 0621ER	U	A02CQ.9	5,30
562.0006.04	ANGLE EXTERIEUR REGL.T.08 80X60 IVOIRE 0821ER	U	0493Q.2	6,04
562.0006.04	ANGLE EXTERIEUR REGL.T.08 80X60 BLC 0821ER-W	U	238L5.3	6,04



ACCESSOIRES

Angle - Intérieur



	DÉSIGNATION	UT	CODE	PPHT (€)
562.0001.58	ANGLE INTERIEUR T.03 25X25 IVOIRE 0305AI	U	3640D.2	1,58
562.0004.29	ANGLE INTERIEUR T.06 60X45 BLANC 0605AI-W	U	A02EC.3	4,29
562.0004.29	ANGLE INTERIEUR T.06 60X45 IVOIRE 0605AI	U	0517M.0	4,29
562.0003.69	ANGLE INTERIEUR T.08 80X60 BLANC 0805AI-W	U	229M7.7	4,92
562.0002.46	ANGLE INTERIEUR T.08 80X60 IVOIRE 0805AI	U	3639F.0	4,92
562.0003.23	ANGLE INTERIEUR T.12 110X75 IVOIRE 1205AI	U	3639G.8	6,46
562.0006.46	ANGLE INTERIEUR T12 110X75 BLANC 1205AI-W	U	229M8.5	6,46

CLIMATISATION

GOULOTTE



ACCESSOIRES

Angle - Interieur réglable



	DÉSIGNATION	UT	CODE	PPHT (€)
562.0006.04	ANGLE INT.REGL.80-105 80X60MM 0820IR	U	A02CR.7	6,04
562.0006.04	ANGLE APPARENT REGL.T.08 80X60 BLANC 0820IR-W	U	0493N.6	6,04



ACCESSOIRES

Angle - Angle vertical gauche



	DÉSIGNATION	UT	CODE	PPHT (€)
562.0008.79	ANGLE VERTICAL 60X45 DROITE BLANC 0614VS-W	U	A02ET.1	8,79
562.0008.79	ANGLE VERTICAL 60X45 DROITE IVOIRE 0614VD	U	A02CX.4	8,79
562.0011.71	ANGLE VERTICAL 80X60 GAUCHE BLANC 0814VS-W	U	A02EN.1	11,71
562.0011.23	ANGLE VERTICAL 80X60 GAUCHE IVOIRE 0814VS	U	0493W.9	11,23



ACCESSOIRES

Angle - Angle vertical droit



	DÉSIGNATION	UT	CODE	PPHT (€)
562.0008.79	ANGLE VERTICAL 60X45 DROITE BLANC 0615VD-W	U	A02ER.5	8,79
562.0008.79	ANGLE VERTICAL 60X45 GAUCHE IVOIRE 0615VS	U	A02CW.6	8,79
562.0011.23	ANGLE VERTICAL 80X60 DROITE IVOIRE 0815VD	U	A00K6.4	11,23
562.0011.71	ANGLE VERTICAL 80X60 DROITE BLANC 0814VD-W	U	A02EQ.7	11,71



ACCESSOIRES

Bouchon



	DÉSIGNATION	UT	CODE	PPHT (€)
562.0000.79	BOUCHON T.03 25X25 IVOIRE 0308TT	U	3640F.7	1,58
562.0004.02	BOUCHON T.06 60X45 IVOIRE 0608TT	U	0494W.8	4,02
562.0003.46	EMBOUT T.08 80X60 BLANC 0808TT-W	U	229MD.4	4,61
562.0002.31	BOUCHON T.08 80X60 IVOIRE 0808TT	U	43289.8	4,62



ACCESSOIRES

Clips - Maintien goulotte



	DÉSIGNATION	UT	CODE	PPHT (€)
562.0000.63	CLIP DE MAINTIEN GOULOT.T.06 60X45 JNE 0603ST	U	A02CY.2	0,63
562.0000.37	CLIP DE MAINTIEN GOULOT.T.08 80X60 RGE 0803ST	U	3640G.5	0,74
562.0000.39	CLIP DE MAINTIEN GOULOT.T12 110X75 VERT1203ST	U	3640H.3	0,79
562.0001.06	CLIP DE MAINTIEN GOULOT.T.14 140X90 IV 1403ST	U	265FV.0	1,06

CLIMATISATION

GOULOTTE



ACCESSOIRES

Embout



DÉSIGNATION	UT	CODE	PPHT (€)
562.0004.02 EMBOUT T.06 60X45 BLANC 0608TT-W	U	A02EH.2	4,02



ACCESSOIRES

Joint et jonction - Joint d'intersection



DÉSIGNATION	UT	CODE	PPHT (€)
562.0002.22 JOINT INTERSECTION T.06 60X45 IVOIRE 0604GC	U	05178.9	2,22
562.0001.43 JOINT INTERSECTION T.08 80X60 IVOIRE 0804GC	U	3640K.8	2,86
562.0001.43 JOINT INTERSECTION GO.T.08 80X60 BLC 0804GC-W	U	238MX.6	2,86
562.0001.75 JOINT INTERSECTION T.12 110X75 IVOIRE 1204GC	U	3640L.6	3,49
562.0003.49 JOINT INTERSECTION GO T12 110X75 BLC 1204GC-W	U	248G2.4	3,49



ACCESSOIRES

Joint et jonction - Joint flexible



DÉSIGNATION	UT	CODE	PPHT (€)
562.0013.67 JONCTION FLEX.T.08 590MM 80X60 IVOIRE 0811GF	U	80577.0	13,67



ACCESSOIRES

Joint et jonction - Jonction linéaire



DÉSIGNATION	UT	CODE	PPHT (€)
562.0001.74 JONCTION PVC TR.TUBE CON.16-18-20IVOIR 0023GL	U	238NP.2	1,74



ACCESSOIRES

Joint et jonction - Couvre joint



DÉSIGNATION	UT	CODE	PPHT (€)
562.0004.50 JOINT INTERSECTION T.14 140X90 IVOIRE 1404GC	U	275FQ.0	4,50



ACCESSOIRES

Passage de mur



DÉSIGNATION	UT	CODE	PPHT (€)
562.0004.71 PASSAGE DE MUR T.06 IVOIRE ARTIPL. 0610PM	U	0495M.6	4,71
562.0003.02 PASSAGE DE MUR T.08 80X60 IVOIRE 0810PM	U	3640I.1	6,04

CLIMATISATION

GOULOTTE



ACCESSOIRES

Passage de mur - suite



DÉSIGNATION	UT	CODE	PPHT (€)
562.0003.02 PASSAGE DE MUR T.08 80X60 BLANC 0810PM-W	U	238N9.3	6,04
562.0003.79 PASSAGE DE MUR T.12 110X75 IVOIRE 1210PM	U	3640J.0	7,57
562.0007.57 PASSAGE DE MUR T12 110X75 BLANC 1210PM-W	U	248G4.0	7,57
999.0011.81 PASSAGE DE MUR T14 110X75 IVOIRE 1410PM	U	265FX.6	11,81



ACCESSOIRES

Raccord en Y - Raccord



DÉSIGNATION	UT	CODE	PPHT (€)
562.0002.54 RACCORD Y IVOIRE 0021GY	U	238NC.6	2,54



ACCESSOIRES

Raccord en Y - Pour tube annelé



DÉSIGNATION	UT	CODE	PPHT (€)
562.0003.55 RACCORD Y TUBE ANNELE 16-18 IVOIRE 0022YU	U	238NE.1	3,55



ACCESSOIRES

Réduction



DÉSIGNATION	UT	CODE	PPHT (€)
562.0003.23 REDUCTION 80X60-60X45 BLANC 8060RI-W	U	A02EK.7	3,23
562.0003.65 REDUCTION 110X75 A 80X60 BLANC 1280RI-W	U	243E8.4	3,65
562.0003.65 REDUCTION 110X75 A 80X60 IVOIRE 1280RI	U	5668I.3	3,65
562.0006.41 REDUCTION 140X90 A 110X75 IVOIRE 1412RI	U	288BD.1	6,41



ACCESSOIRES

Siphon



DÉSIGNATION	UT	CODE	PPHT (€)
562.0002.78 SIPHON PVC TR.TUBE CON.16-18-20 0024SF	U	238NG.7	5,56

CLIMATISATION

GOULOTTE



ACCESSOIRES

Sortie de mur



	DÉSIGNATION	UT	CODE	PPHT (€)
562.0005.88	SORTIE DE MUR T.06 60X45 BLANC 0609CM-W	U	A02E4.1	5,88
562.0005.88	SORTIE DE MUR T.06 60X45 IVOIRE 0609CM	U	0494Y.4	5,88
562.0003.49	SORTIE DE MUR T.08 80X60 BLANC 0809CM-W	U	238NU.1	6,99
562.0003.49	SORTIE DE MUR T.08 80X60 IVOIRE 0809CM	U	3641F.6	6,99
562.0009.48	SORTIE DE MUR T12 110X75 BLANC 1209CM-W	U	248FR.5	9,48
562.0004.74	SORTIE DE MUR T.12 110X75 IVOIRE 1209CM	U	3641G.4	9,48
562.0013.67	SORTIE DE MUR T.14 140X90 IVOIRE 1409CM	U	275FS.6	13,67



ACCESSOIRES

Té - De dérivation



	DÉSIGNATION	UT	CODE	PPHT (€)
562.0005.59	TE DE DERIVATION T.08 80X60 IVOIRE 0813DT	U	3641H.2	11,18
562.0005.59	TE DE DERIVATION T.08 80X60 BLC 0813DT-W	U	238NY.3	11,18
562.0006.97	TE DE DERIVATION T.12 110X75 IVOIRE 1213DT	U	3641I.0	13,93
562.0013.93	TE DE DERIVATION T.12 110X75 BLC 1213DT-W	U	288B9.0	13,93
562.0019.55	TE DE DERIVATION T.14 140X90 IVOIRE 1413DT	U	288BC.3	19,55



ACCESSOIRES

Té - Pour tube condensat



	DÉSIGNATION	UT	CODE	PPHT (€)
562.0004.02	TE PVC TRANSP.P/TUB.CON.16-18-20 IVOIR 0025GT	U	238P1.4	4,02



ACCESSOIRES

Tube annelé - Lisse - condensat intérieur



	DÉSIGNATION	UT	CODE	PPHT (€)
562.0061.63	TUBE ANN.COND.INT.LIS.16 30ML BLANC 0016TU	U	238P2.2	61,63



GOULOTTE

Bande isolante



	DÉSIGNATION	UT	CODE	PPHT (€)
562.0015.87	BANDE ISO.GAU.BLC 10MLX50MMX3MM IT-W-10M PS	U	234EM.4	21,16
562.0010.40	BANDE ISO.GAU.NR 15MLX50MMX3MM IT-BL-15M	U	234EN.2	13,86

CLIMATISATION

PLENUM CLIM

atlantic

REPRISE D'AIR

Bride ou plénum de reprise - Bride



	DÉSIGNATION	UT	CODE	PPHT (€)	ECOPART (€)
573.0076.00	BRIDE DE REPRISE B4X200 L/U 809906	U	0102L.3	152,04	0,04
573.0063.00	BRIDE REPRISE B2 X 200 S1 809914	U	96171.7	126,04	0,04
573.0067.00	BRIDE REPRISE B2 X 200 S2 809917	U	32489.7	134,05	0,05

atlantic

REPRISE D'AIR

Ensemble de reprise



	DÉSIGNATION	UT	CODE	PPHT (€)	ECOPART (€)
573.0334.50	PLENUM DE REPRISE ER25/60 -ENS- 809925	U	0103D.8	669,42	0,42
573.0271.50	PLENUM DE REPRISE ER18/30 -ENS- 809926	U	0103C.0	543,32	0,32

atlantic

SOUFFLAGE D'AIR

Bride - 3 piquages



	DÉSIGNATION	UT	CODE	PPHT (€)	ECOPART (€)
573.0077.00	BRIDE DE SOUFFLAGE B3X160 S1 809106	U	94422.3	154,04	0,04

atlantic

SOUFFLAGE D'AIR

Bride ou plénum de soufflage - Brides



	DÉSIGNATION	UT	CODE	PPHT (€)	ECOPART (€)
573.0085.00	BRIDE DE SOUFFLAGE B4X160 S2 875000	U	1251T.6	170,05	0,05

PLENUM REGULATION

AIRZONE

PLENUM EASYZONE - PACK

Pour MITSUBIHI



	DÉSIGNATION	UT	CODE	PPHT (€)
562.1376.25	PACK PLENUM EASYZONE 6X200 2X250 PP6MELBS01M6	U	243AU.4	2752,51
562.1241.27	PACK PLENUM EASYZONE 3X200 1X250 PP8MELBS01S3	U	333M8.5	2482,54
562.1329.99	PACK PLENUM EASYZONE 4X200 1X250 PP8MELBS01S4	U	333M9.3	2659,99
562.1329.99	PACK PLENUM EASYZONE 4X200 2X250 PP8MELBS01M4	U	333MC.6	2659,99
562.1329.99	PACK PLENUM EASYZONE 4X200 4X250 PP8MELBS01L4	U	333MG.7	2659,99

Le PPHT comprend l'ecopart (€)

CLIMATISATION

PLENUM REGULATION

AIRZONE

PLENUM EASYZONE - PACK

Pour MITSUBIHI

- suite



	DÉSIGNATION	UT	CODE	PPHT (€)
562.1419.55	PACK PLENUM EASYZONE 5X200 4X250 PP8MELBS01L5	U	333MK.0	2839,10
562.1419.55	PACK PLENUM EASYZONE 5X200 1X250 PP8MELBS01S5	U	333MA.0	2839,10
562.1419.55	PACK PLENUM EASYZONE 5X200 2X250 PP8MELBS01M5	U	333MD.4	2839,10
562.1508.27	PACK PLENUM EASYZONE 6X200 4X250 PP8MELBS01L6	U	333ML.8	3016,55
562.3016.55	PACK PLENUM EASYZONE 6X200 2X250 PP8MELBS01M6	U	333ME.1	3016,55

AIRZONE

CABLE BUS

Câble bus - Câble 100m



	DÉSIGNATION	UT	CODE	PPHT (€)
562.0096.25	CABLE BUS AIRZONE -100M- AZX6CABLEBUS100	U	228AC.0	192,51

AIRZONE

CABLE BUS

Câble bus - Câble 15m



	DÉSIGNATION	UT	CODE	PPHT (€)
562.0021.10	CABLE BUS AIRZONE -15M- AZX6CABLEBUS15	U	301PK.0	42,20

atlantic

SYSTEME ZONE CONTROL 2.0

Kit 1 zone - Zone plus 160/200



	DÉSIGNATION	UT	CODE	PPHT (€)	ECOPART (€)
573.0281.50	PLENUM ZONE PLUS 160/200 875052	U	2245A.9	564,67	1,67

atlantic

SYSTEME ZONE CONTROL 2.0

Sonde - Pack sonde



	DÉSIGNATION	UT	CODE	PPHT (€)	ECOPART (€)
573.0656.00	SONDE PILES 5ZONES -PACK- 875098	U	2156W.3	1312,12	0,12

CLIMATISATION

PLENUM REGULATION

atlantic

SHOGUN MONOSPLIT MULTI

ZONES

SHOGUN ZC S3



	DÉSIGNATION	UT	CODE	PPHT (€)	ECOPART (€)
573.1445.49	PLENUM SHOGUN ZC 160 S3 875126	U	254HF.2	2892,66	1,67

atlantic

SHOGUN MONOSPLIT MULTI

ZONES

SHOGUN ZC S4



	DÉSIGNATION	UT	CODE	PPHT (€)	ECOPART (€)
573.1580.49	PLENUM SHOGUN ZC 160 S4 875127	U	254HG.0	3162,66	1,67

HABILLAGE



Changes for the Better

FACADE UNITE INTERIEURE

Façade - Façade sans 3D I see Sensor



	DÉSIGNATION	UT	CODE	PPHT (€)
931.0137.50	FACADE CASSETTE SLZ-KFY-VFM 289297 SLP-ZFAL	U	8389G.9	275,00

SUPPORTS ET FIXATIONS



SUPPORTS AU SOL

Long - Par 2



	DÉSIGNATION	UT	CODE	PPHT (€)
562.0014.23	SUPPORT 80X80X450 0.45M 125KG-2-IVOIRE 0451SP	U	3641D.1	18,97
562.0032.51	SUPPORT 80X80X1000 1ML 150KG-2-IVOIRE 1001SP	U	3641E.8	43,35



SUPPORTS AU SOL

Conique - Par 4



	DÉSIGNATION	UT	CODE	PPHT (€)
562.0007.41	SUPPORT AU SOL CONIQUE -4- 0501SC	U	288BJ.9	7,41

Le PPHT comprend l'ecopart (€)

Les tarifs et disponibilités de nos produits peuvent évoluer sans préavis

RICHARDSON

| 307 |

CLIMATISATION

SUPPORTS ET FIXATIONS



SUPPORTS AU SOL

Bouchon pour support de sol



	DÉSIGNATION	UT	CODE	PPHT (€)
562.0002.12	EMBOUT DE SUPPORT SOL 80X80MM IVOIRE 0342TS	U	3639L.9	4,24



MONTAGE ET FIXATION

Clip pour fixation tuyaux évacuation



	DÉSIGNATION	UT	CODE	PPHT (€)
000.0000.42	CLIP P.FIXATION MUR.TUBE D20 B3305	U	A0011.5	0,53



MONTAGE ET FIXATION

Embout pour profil - 100mm

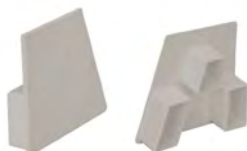

	DÉSIGNATION	UT	CODE	PPHT (€)
000.0001.59	EMBOUT P/SUPPORT AU SOL 80MM BLC 175ACL0057	U	9162Y.6	1,59



SUPPORTS MURAUX ET AU SOL

Support équerre - BBJ Bracket - 4 pièces - Fourni avec plots antivibratiles



	DÉSIGNATION	UT	CODE	PPHT (€)
000.0005.70	SUPPORT PLOT ANTIV.TIGE FIL.M8-S4- 175ACL0185	U	2826E.7	7,60



SUPPORTS

Réglable - Equerre - SI 1301 - Avec niveau



	DÉSIGNATION	UT	CODE	PPHT (€)
562.0020.65	SUPPORT REGL.EQ.+NIV.800X420/140KG SI 1301	U	96552.5	41,30



SUPPORTS

Réglable - Equerre - SI 1402 - Avec niveau



	DÉSIGNATION	UT	CODE	PPHT (€)
562.0040.70	SUPPORT REGL.EQ.+NIV.800X465/140KG SI 1402	U	222EW.0	40,70

CLIMATISATION

SUPPORTS ET FIXATIONS



SUPPORTS

Réglable - Equerre - SI 1503 - Avec niveau



	DÉSIGNATION	UT	CODE	PPHT (€)
562.0020.54	SUPPORT REGL.EQ.+NIV.800X550/140KG SI 1503	U	2283B.0	51,36



SUPPORTS

Réglable - Equerre - SI 9002 - Avec niveau



	DÉSIGNATION	UT	CODE	PPHT (€)
562.0125.90	SUPP. TOIT REGL.EQ.+NIV.800X520/140KG SI9	U	233TP.3	125,90



SUPPORTS

Support sol Rubber



	DÉSIGNATION	UT	CODE	PPHT (€)
562.0055.25	SUPPORT RUBBER DXL 600X180X95 -2- DXL 600	U	233UN.4	92,09
908.0043.52	SUPPORT RUBBER DXL 450X180X95 -PAIRE- DXL 450	U	272EA.8	72,54

ENTRETIEN



NETTOYANTS POUR EVAPORATEURS

Nettoyant et désinfectant - Advanced gel EC



	DÉSIGNATION	UT	CODE	PPHT (€)
000.0037.92	NETTOYANT EVAP.ADVANCED GEL 490ML S010458R1	U	387PP.1	37,92



NETTOYANTS POUR EVAPORATEURS

Nettoyant et désinfectant - EasyCare



	DÉSIGNATION	UT	CODE	PPHT (€)
000.0017.30	DESINFECTANT EASYCARECLEANER 600ML 177ACE0016	U	5657D.7	23,07

CLIMATISATION

ENTRETIEN



NETTOYANTS POUR EVAPORATEURS

Nettoyant et désinfectant - EasyClean



	DÉSIGNATION	UT	CODE	PPHT (€)
000.0023.07	EASYSOL AEROSOL 600ML 177ACE0015	U	252KW.1	23,07



NETTOYANTS POUR EVAPORATEURS

Nettoyant et désinfectant - CondenCide



	DÉSIGNATION	UT	CODE	PPHT (€)
000.0074.26	NETTOYANT CONDENCIDE BIDON 5L 177ACE0033	U	229P3.9	99,02



NETTOYANTS POUR EVAPORATEURS

Nettoyant et désinfectant - Rtu Ecd



	DÉSIGNATION	UT	CODE	PPHT (€)
000.0022.18	NETTOYANT DESINFECT.RTU ECD 177ACE0013	U	229L7.8	29,58



NETTOYANTS POUR CONDENSEURS

EasyFoam pour les unités extérieures



	DÉSIGNATION	UT	CODE	PPHT (€)
000.0017.30	NETTOYANT CONDENSEUR EASYFOAM 600 177ACE0024	U	3956V.5	23,07



NETTOYANTS POUR CONDENSEURS

EasyFoam pour les unités extérieures - SuperClean



	DÉSIGNATION	UT	CODE	PPHT (€)
000.0082.42	NETTOYANT CONDENS.EXT.SUPERCLEAN 177ACE0036	U	229L8.6	109,90

CLIMATISATION

ENTRETIEN



NETTOYANTS POUR CONDENSEURS

Nettoyant pour condenseur - Advanced gel CC



	DÉSIGNATION	UT	CODE	PPHT (€)
000.0037.92	NETTOYANT COND.ADVANCED GEL 490ML S010457R1	U	A001G.2	37,92



NETTOYANTS POUR CONDENSEURS

Nettoyant pour condenseur - RTU CC



	DÉSIGNATION	UT	CODE	PPHT (€)
000.0022.18	NETTOYANT CONDENSEUR EXT.RTU CC 177ACE0012	U	229L6.0	29,58



TRAITEMENT DES ODEURS

StayClean pour les bacs



	DÉSIGNATION	UT	CODE	PPHT (€)
000.0008.38	ANTI-BACTERIEN STAYCLEAN -20PAST.- 177ACE0003	U	3949Y.9	11,17



TRAITEMENT DES ODEURS

EasyFresh



	DÉSIGNATION	UT	CODE	PPHT (€)
000.0015.47	DESODORISANT EASYFRESH 177ACE0080	U	229KS.8	20,63
000.0011.80	DESODORISANT SMELLYJELLY M.MIX-20- S090054MWE	U	253YF.3	15,73



TRAITEMENT DES ODEURS

Odourguard



	DÉSIGNATION	UT	CODE	PPHT (€)
000.0022.18	ELIMINATEUR D'ODEURS RTU ODOURGUARD S090070R1	U	355C4.7	29,58

CLIMATISATION

ENTRETIEN



DETECTEUR DE FUITES GAZ ELECTRONIQUE PROFIND+



	DÉSIGNATION	UT	CODE	PPHT (€)
000.0268.52	DETECTEUR DE FUITE FRIGO.PROFIND JAV-1089	U	336QC.1	358,02



DETECTEURS DE FUITES TYPE A BULLES EasyFind



	DÉSIGNATION	UT	CODE	PPHT (€)
000.0017.30	DETECTEUR FUITES EASYFIND -400ML- 177ACE0074	U	207YR.8	23,07



PRODUITS ASTUCIEUX

Nettoyant et désinfectant - GainClean pour gaine de climatisation



	DÉSIGNATION	UT	CODE	PPHT (€)
000.0015.28	NETTOYANT DESINF.GAINCLEAN 150ML 177ACE0069	U	6727U.8	20,37



PRODUITS ASTUCIEUX

Nettoyant et désinfectant - EasyFinish pour les surfaces en plastique ou métal



	DÉSIGNATION	UT	CODE	PPHT (€)
000.0017.30	NETTOYANT PLASTIQUE EASYFINISH 600 177ACE0017	U	3955U.8	23,07



PRODUITS ASTUCIEUX

Déboucheur de tuyaux - DrainKleen One Shot



	DÉSIGNATION	UT	CODE	PPHT (€)
000.0008.33	DEBOUCHEUR TUYAU EVAC.DRAINKLEEN 177ACE0002	U	229KR.0	11,11

CLIMATISATION

ENTRETIEN



ACCESSOIRES

De nettoyage - Pulvérisateur hydrosprayer



	DÉSIGNATION	UT	CODE	PPHT (€)
000.0070.66	PULVERISATEUR HYDROSPRAYER -8L- S010107	U	333SF.9	94,22



ACCESSOIRES

De nettoyage - EasyWipes pour les surfaces en plastique ou métal



	DÉSIGNATION	UT	CODE	PPHT (€)
000.0006.23	LINGETTE CLIM.EASYWIPES -50- 177ACE0038	U	7181U.5	8,31



ACCESSOIRES

Divers - EasyCoat - Vernis acrylique anti-corrosion



	DÉSIGNATION	UT	CODE	PPHT (€)
000.0017.30	VERNIS ANTI-CORROSION EASYCOAT 177ACE0023	U	229L9.4	23,07



FLUIDE CALOPORTEUR

MPG Concentré - MB444 E



	DÉSIGNATION	UT	CODE	PPHT (€)
000.0175.55	FLUIDE CALOPORTEUR CONCENTRE MB444E 20L 9558	U	35108.0	219,44



FLUIDE CALOPORTEUR

MPG Pré-dilué - CALOP30



	DÉSIGNATION	UT	CODE	PPHT (€)
000.0099.45	FLUIDE CALOPORT.PRE-DILUE CALOP30E -20L- 9567	U	346CW.9	132,60

VENTILATION

VMC INDIVIDUELLE AUTOREGLABLE



AUTOREGLABLE - SIMPLE FLUX

VMC EASYHOME - AUTO COMPACT - Classic - Accessoires



	DÉSIGNATION	UT	CODE	PPHT (€)	ECOPART (€)
560.0015.65	KIT COMPL.WC AUTO+GRIL.BIP EASYHOME 11026040	U	167VD.3	15,66	0,01



AUTOREGLABLE - SIMPLE FLUX

VMC AUTOCOSY - Kit



	DÉSIGNATION	UT	CODE	PPHT (€)	ECOPART (€)
574.0090.20	KIT AUTOCOSY AUTOREG. 4SANIT.+3BOUCHES 412288	U	169AY.3	164,83	0,83



AUTOREGLABLE - SIMPLE FLUX

VMC AUTOCOSY IH - Kit



	DÉSIGNATION	UT	CODE	PPHT (€)	ECOPART (€)
574.0162.75	KIT AUTOCOSY IH VMC AUTOREGLABLE 412289	U	168KL.0	217,83	0,83



AUTOREGLABLE - SIMPLE FLUX

VMC AUTOCOSY IH FLEX - Kit



	DÉSIGNATION	UT	CODE	PPHT (€)	ECOPART (€)
574.0154.00	KIT AUTOCOSY IH FLEX 4SANIT.+3 BOUCHES 412290	U	95976.7	280,83	0,83



ACCESSOIRES

Accessoires - Kit accessoires



	DÉSIGNATION	UT	CODE	PPHT (€)	ECOPART (€)
574.0430.20	KIT PILES HYGROCOSY BC FLEX +VMC 412278	U	257BW.9	717,83	0,83

VENTILATION

VMC INDIVIDUELLE AUTOREGLABLE



AUTOREGLABLE - SIMPLE FLUX

VMC DECO 2 - Kit



	DÉSIGNATION	UT	CODE	PPHT (€)	ECOPART (€)
560.0134.14	KIT VMC AUTO DECO 2K B00125+2BD080 604141	U	173JB.1	168,51	0,83



AUTOREGLABLE - SIMPLE FLUX

VMC DECO DHU - Sonde hygrométrique - Kit



	DÉSIGNATION	UT	CODE	PPHT (€)	ECOPART (€)
571.0156.74	KIT VMC DECO DHU K A SONDE PAVI. 603116	U	8143F.8	196,75	0,83



AUTOREGLABLE - SIMPLE FLUX

VMC OCTEO AUTO DHU - Sonde hygrométrique - Kit jusqu'à 6 sanitaires



	DÉSIGNATION	UT	CODE	PPHT (€)	ECOPART (€)
571.0324.43	KIT VMC SONDE THERMO-HYGROM.6 SANIT. 607311	U	396K5.0	407,21	1,67

VMC INDIVIDUELLE HYGROREGLABLE



HYGROREGLABLE - SIMPLE FLUX

VMC HYGROCOSY - Kit



	DÉSIGNATION	UT	CODE	PPHT (€)	ECOPART (€)
574.0291.50	KIT PILES HYGROCOSY VMC SIMPLE FLUX 412292	U	167TX.6	530,83	0,83



HYGROREGLABLE - SIMPLE FLUX

VMC HYGROCOSY FLEX - Kit



	DÉSIGNATION	UT	CODE	PPHT (€)	ECOPART (€)
574.0427.50	KIT VMC HYGROCOSY FLEX PILE T3/T7 412295	U	168SD.4	570,83	0,83

Le PPHT comprend l'ecopart (€)

VENTILATION

VMC INDIVIDUELLE HYGROREGLABLE



HYGROREGLABLE - SIMPLE FLUX

VMC OCTEO HYGRO Standard - Kit tous chantiers



	DÉSIGNATION	UT	CODE	PPHT (€)	ECOPART (€)
571.0465.60	KIT VMC HYGRO STANDARD OCTEO HYGRO 607711	U	396K1.9	583,67	1,67

VMC COLLECTIVE



ACCESSOIRES

Manchette souple



	DÉSIGNATION	UT	CODE	PPHT (€)
560.0063.84	MANCHETTE SOUPLE 400/2H D.160 975615	U	15886.5	79,80
571.0069.48	MANCHETTE SOUPLE 400/2H D.200 975616	U	1727K.8	86,85
560.0071.00	MANCHETTE SOUPLE 400/2H D.250 975617	U	1588F.5	88,75



ACCESSOIRES

Ventilateur tertiaire inline - JETLINE



	DÉSIGNATION	UT	CODE	PPHT (€)	ECOPART (€)
571.0502.86	VENTILATEUR TERT.INLINE 300M3/H D125 246000	U	251RA.5	628,77	0,20
571.0561.06	VENTILATEUR TERT.INLINE 600M3/H D160 246100	U	251RP.7	701,59	0,27

VMC TERTIAIRE



CAISSON D'EXTRACTION SIMPLE FLUX

C4 - Flux à 90



	DÉSIGNATION	UT	CODE	PPHT (€)	ECOPART (€)
560.0914.74	CAISSON C4 500M3/H FLUX 90 200MM 230561	U	189VN.7	1144,36	0,94

VENTILATION

GAINES ET CONDUITS RESIDENTIEL



CONDUIT CIRCULAIRE FLEXIBLE

Algaïne PVC Standard compact



	DÉSIGNATION	UT	CODE	PPHT (€)	ECOPART (€)
560.0054.94	CONDUIT ALGAÏNE STANDARD PVC 80 20M 11091198	U	28174.1	73,28	0,02



CONDUIT CIRCULAIRE FLEXIBLE

Algaïne isolée - Epaisseur 25 mm - Epaisseur 25 mm



	DÉSIGNATION	UT	CODE	PPHT (€)	ECOPART (€)
560.0041.11	CONDUIT ALGAÏNE ISOLEE 80 -6M- 11091619	U	13459.3	54,83	0,02



CONDUIT SOUPLE CIRCULAIRE

T...B PVC standard spiralé



	DÉSIGNATION	UT	CODE	PPHT (€)	ECOPART (€)
572.0030.22	CONDUIT PVC SOUPLE D160 6M T162B 423070	U	36920.5	40,33	0,03



CONDUIT SOUPLE CIRCULAIRE

T...CR PVC - Calorifugé



	DÉSIGNATION	UT	CODE	PPHT (€)
572.0033.75	CONDUIT SOUPLE CALOR.PVC 6M T82CR 80 423050	U	7652H.9	67,50
572.0046.05	CONDUIT SOUPLE CALO. T 127 CR L6M D125 423053	U	7652G.1	92,10
572.0093.75	CONDUIT SOUPLE CALO. T 162 CR L6M D160 423142	U	2543S.4	125,00



CONDUIT SOUPLE CIRCULAIRE

Hexagaine - Conduit souple en tissu PVC



	DÉSIGNATION	UT	CODE	PPHT (€)	ECOPART (€)
572.0032.20	CONDUIT SOUPLE PVC HEXAGAIN 80 D80 423360	U	41798.0	64,45	0,05
572.0048.90	CONDUIT SOUPLE PVC HEXAGAIN 125 D125 423362	U	41809.5	97,88	0,08

Le PPHT comprend l'ecopart (€)

VENTILATION

GAINES ET CONDUITS RESIDENTIEL

atlantic

CONDUIT SOUPLE RECTANGULAIRE
TR...A PVC renforcée avec spirale en fil d'acier
- Longueur 6m



	DÉSIGNATION	UT	CODE	PPHT (€)	ECOPART (€)
572.0051.30	CONDUIT SOUPLE 6M TR100/40 PVC 423046	U	80349.4	51,33	0,03
572.0074.70	CONDUIT SOUPLE 6M TR140/60 PVC 423048	U	90276.5	74,74	0,04

atlantic

ACCESSOIRES
CPR - Chapeau de toiture - Rouge



	DÉSIGNATION	UT	CODE	PPHT (€)	ECOPART (€)
572.0112.00	CHAPEAU TOITURE RGE CPR 160 R D160 422962	U	01435.2	112,14	0,14

GAINES ET CONDUITS TERTIAIRE

atlantic

ACCESSOIRES
BMF Bouchon mâle femelle - Galva standard



	DÉSIGNATION	UT	CODE	PPHT (€)	ECOPART (€)
571.0005.70	BOUCHON MALE/FEMELLE BMF 160 523442	U	3396L.2	5,71	0,01
571.0005.32	BOUCHON MALE/FEMELLE BMF 200 523443	U	33974.7	7,11	0,01

atlantic

ACCESSOIRES
Bouton poussoir universel



	DÉSIGNATION	UT	CODE	PPHT (€)	ECOPART (€)
571.0007.62	BOUTON POUSSOIR P/BOUCHE ELEC./A PILES 420931	U	9293L.3	12,87	0,17

atlantic

ACCESSOIRES
Collier de serrage - Par 10



	DÉSIGNATION	UT	CODE	PPHT (€)	ECOPART (€)
571.0011.28	COLLIER SERRAGE C 82 -SACHET 10- 423348	U	86060.1	18,81	0,01
571.0014.04	COLLIER MONOFIL C 127 -SACHET 10- 423350	U	86064.3	23,41	0,01

Le PPHT comprend l'ecopart (€)

VENTILATION

GAINES ET CONDUITS TERTIAIRE

atlantic

ACCESSOIRES
Patte de fixation



	DÉSIGNATION	UT	CODE	PPHT (€)	ECOPART (€)
571.0016.88	PATTE DE FIXATION PLACO -JEU 2- 536792	U	7212J.9	22,51	0,01

atlantic

ACCESSOIRES
RFT Raccord femelle - Entre deux accessoires - Galva standard



	DÉSIGNATION	UT	CODE	PPHT (€)	ECOPART (€)
571.0004.72	RACCORD FEMELLE GALVA D200 RFT200 523433	U	3541D.2	6,31	0,01

atlantic

ACCESSOIRES
RMT Raccord mâle - Entre deux conduits - Galva standard



	DÉSIGNATION	UT	CODE	PPHT (€)	ECOPART (€)
571.0003.82	RACCORD MALE GALVA D160 RMT160 523422	U	0568F.1	5,11	0,01
571.0003.82	RACCORD MALE GALVA D200 RMT200 523423	U	3394H.1	5,11	0,01

atlantic

ACCESSOIRES
RCC Réduction conique concentrique - Galva standard



	DÉSIGNATION	UT	CODE	PPHT (€)	ECOPART (€)
571.0015.45	REDUCTION CONIQUE D.200/160 523472	U	0038L.2	20,61	0,01

atlantic

ACCESSOIRES
Ruban adhésif



	DÉSIGNATION	UT	CODE	PPHT (€)	ECOPART (€)
571.0016.00	BANDE ADHESIVE 33M RAV50 547579	U	6905D.5	16,01	0,01

VENTILATION

GRILLE ET DIFFUSEUR



GRILLE AILETTE GAC-B



	DÉSIGNATION	UT	CODE	PPHT (€)
025.0021.28	GRILLE AILETTE GAC-B 300X150 GAC300X150B	U	321BL.4	28,37
025.0020.26	GRILLE AILETTE GAC-B 400X150 GAC400X150B	U	321BM.2	27,02



GRILLE DE REPRISE GFA+F



	DÉSIGNATION	UT	CODE	PPHT (€)
999.0112.87	GRILLE REPR.AILETT.45D FILT.G3 GFA+F600X300B	U	321D1.4	112,87



GRILLE DOUBLE DEFLEXION GDD-B



	DÉSIGNATION	UT	CODE	PPHT (€)
025.0018.19	GRILLE DBLE DEF.GDD-B 300X100 GDD300X100B	U	335EC.9	24,25
025.0021.28	GRILLE DBLE DEF.GDD-B 300X150 GDD300X150B	U	321BC.2	28,37
025.0020.26	GRILLE DBLE DEF.GDD-B 400X150 GDD400X150B	U	321BD.0	27,02



PLENUM DE REPRISE ISOLE PLGREP



	DÉSIGNATION	UT	CODE	PPHT (€)
999.0120.35	PLENUM REPR.ISOL PRED.600X300 PLGREP600X300	U	392J4.3	120,35



GRILLE DE SOUFLAGE À lames courbes - RAL 9010



	DÉSIGNATION	UT	CODE	PPHT (€)
562.0041.85	GRILLE LAMES COURBES 300X150 GSLC-300X150	U	335DU.5	55,80
562.0045.96	GRILLE LAMES COURBES 400X150 GSLC-400X150	U	335DW.1	61,28

VENTILATION

GRILLE ET DIFFUSEUR



GRILLE DE SOUFLAGE Double déflexion - RAL 9010



	DÉSIGNATION	UT	CODE	PPHT (€)
562.0028.51	GRILLE DBL DEFLEXION 300X100 GS2D-300X100	U	335DG.1	38,01
562.0031.11	GRILLE DBL DEFLEXION 300X150 GS2D-300X150	U	335DQ.4	41,48
562.0040.54	GRILLE DBL DEFLEXION 400X150 GS2D-400X150	U	335DS.0	54,05



PLENUM DE SOUFLAGE ABS RAL 9010



	DÉSIGNATION	UT	CODE	PPHT (€)
562.0027.10	PLENUM DE SOUFLAGE ABS 300X100 PSABS-300X100	U	335DY.7	36,13
562.0031.60	PLENUM DE SOUFLAGE ABS 300X150 PSABS-300X150	U	335E0.5	42,14
562.0034.79	PLENUM DE SOUFLAGE ABS 400X150 PSABS-400X150	U	335E2.1	46,39



GRILLE INTERIEURE

SR - De reprise - A ailettes - Emboutie - SR377 - Acier - Blanc



	DÉSIGNATION	UT	CODE	PPHT (€)	ECOPART (€)
563.0015.22	GRILLE ACIER EMBOUTIE 203X102 11050260	U	82924.2	20,30	0,01
563.0018.20	GRILLE ACIER EMBOUTIE 250X100 11050261	U	1977B.3	24,28	0,01
563.0035.19	GRILLE ACIER EMBOUTIE 305X305 11050265	U	82930.9	46,93	0,01



GRILLE INTERIEURE

GAT - Aération - A ailettes inclinées - Emboutie - Avec grillage anti-moustique



	DÉSIGNATION	UT	CODE	PPHT (€)	ECOPART (€)
563.0009.27	GRILLE GAT 150X150 ALU+GAM 11001024	U	1956B.8	12,37	0,01
563.0010.42	GRILLE GAT 150X200 ALU+GAM 11001025	U	1962B.0	13,91	0,01
563.0012.82	GRILLE GAT 200X200 ALU+GAM 11001029	U	1959B.5	17,10	0,01
563.0016.91	GRILLE GAT 250X250 ALU+GAM 11001030	U	1971B.9	22,56	0,01



GRILLE INTERIEURE

GAT - Aération - A ailettes inclinées - Emboutie - Sans grillage anti-moustique



	DÉSIGNATION	UT	CODE	PPHT (€)	ECOPART (€)
563.0006.57	GRILLE GAT 150X150 GALVA BLC 11001000	U	54521.0	8,77	0,01

Le PPHT comprend l'ecopart (€)

VENTILATION

GRILLE ET DIFFUSEUR

atlantic

GRILLE DE SOUFFLAGE

GDD - Grille alu double déflexion

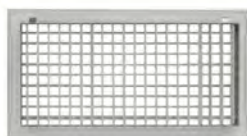

	DÉSIGNATION	UT	CODE	PPHT (€)	ECOPART (€)
571.0042.60	GRILLE ALU DBLE DEF. GDD 300X150 542178	U	318NW.7	42,61	0,01
571.0057.30	GRILLE ALU DBLE DEF. GDD 400X150 542179	U	319L5.1	57,31	0,01

atlantic

GRILLE DE SOUFFLAGE

GPF - Aluminium - Finition blanc



	DÉSIGNATION	UT	CODE	PPHT (€)	ECOPART (€)
571.0231.75	GRILLE ALU BLC P/FILT.GPF 600X600 528714	U	17504.1	309,08	0,08

atlantic

PLENUM

BBG - Plénum ABS pour diffuseur - Piquage arrière



	DÉSIGNATION	UT	CODE	PPHT (€)	ECOPART (€)
571.0040.50	PLENUM ABS BBG 300X150 PIQ.ARR. 535993	U	3578D.8	54,01	0,01
571.0044.25	PLENUM ABS BBG 400X150 PIQ.ARR. 535995	U	4680C.3	59,02	0,02

AIRZONE

DIFFUSEUR

Reprise - Pack



	DÉSIGNATION	UT	CODE	PPHT (€)
562.0275.97	PACK REPRISE T5 500X500MM PLEN.5X250MM AZFPR5	U	2363T.9	551,93

Nicoll
by aliaxis

GRILLE D'AERATION A VISSER

En aluminium gris - Persiennes - Avec moustiquaire - Carrée



	DÉSIGNATION	UT	CODE	PPHT (€)
561.0014.56	GRILLE PERSIEN.AV.MOUST.20X20 ALU GR.1LM2020G	U	61774.6	19,42
561.0009.06	GRILLE PERSIEN.AV.MOUST.15X15 ALU GR. LM1515G	U	36200.4	12,08

VENTILATION

GRILLE ET DIFFUSEUR

Nicoll
by aliaxis

GRILLE D'AERATION A VISSER

En aluminium gris - Persiennes - Avec moustiquaire - Rectangulaire horizontale



	DÉSIGNATION	UT	CODE	PPHT (€)
561.0009.50	GRILLE PERSIEN.AV.MOUST.10X20 ALU GR. LM1020G	U	36198.0	12,67

Nicoll
by aliaxis

GRILLE D'AERATION A VISSER

En aluminium gris - Persiennes - Avec moustiquaire - Rectangulaire verticale



	DÉSIGNATION	UT	CODE	PPHT (€)
561.0010.60	GRILLE PERSIEN.AV.MOUST.20X10 ALU GR.1LM2010G	U	61772.0	14,13

Nicoll
by aliaxis

GRILLE D'AERATION A VISSER OU COLLER

Classique carrée ou rectangulaire - Ronde tuyau film ciment avec moustiquaire



	DÉSIGNATION	UT	CODE	PPHT (€)
561.0006.39	GRILLE RDE TUY.FIBRE AV.MOUST.D100BL.UBC110	U	18390.5	8,52

Nicoll
by aliaxis

GRILLE D'AERATION - SPECIALE FAÇADE

Pour tube PVC - Avec moustiquaire - Extérieure



	DÉSIGNATION	UT	CODE	PPHT (€)
561.0017.98	GRILLE ADAPT.S/TUBE AV.MOUST.D125SBL.1GETM125	U	05161.5	23,97

Nicoll
by aliaxis

GRILLE POUR TUBE PVC - TUYAUX - GAINES

Intérieur ronde blanche adaptable sur tube PVC - Simple - Avec moustiquaire



	DÉSIGNATION	UT	CODE	PPHT (€)
561.0011.02	GRILLE RDE INTERIEUR.AV.MOUST.D080BL.UGATM80	U	17772.5	14,70
561.0011.76	GRILLE RDE INTERIEUR.AV.MOUST.D100BL.UGATM100	U	63268.7	15,68
561.0012.56	GRILLE RDE INTERIEUR.AV.MOUST.D125BL.UGATM125	U	63267.9	16,74

Le PPHT comprend l'ecopart (€)

VENTILATION

GRILLE ET DIFFUSEUR



GRILLE DE SOUFLAGE/REPRISE D'AIR EXTERIEUR

Aluminium



	DÉSIGNATION	UT	CODE	PPHT (€)
560.0007.77	GRILLE SOUFLAGE AIR EXT.165X165 ALU 870215	U	3766U.7	9,71
560.0010.33	GRILLE SOUFLAGE AIR EXT.200X200 ALU 870216	U	7225H.7	12,91
560.0012.73	GRILLE SOUFLAGE AIR EXT.210X210 ALU 870217	U	0419A.3	15,91



SORTIE ET PRISE D'AIR - APC

Auvent pare-pluie - Avec grillage anti-volatile - Galva



	DÉSIGNATION	UT	CODE	PPHT (€)
560.0052.14	AUVENT PARE-PLUIE GALVA 125 875062	U	8133A.1	65,17
560.0070.01	AUVENT PARE-PLUIE GALVA 160 875063	U	6170A.9	87,51
560.0066.35	AUVENT PARE-PLUIE GALVA 200 874636	U	2195E.0	82,94
560.0076.78	AUVENT PARE-PLUIE GALVA 250 874474	U	6599R.0	95,97
560.0100.02	AUVENT PARE-PLUIE GALVA 315 875064	U	88839.6	125,03

DISTRIBUTION D'AIR ET CONDUITS

atlantic

CONDUIT CIRCULAIRE RIGIDE

Culotte à 90° - Galva standard



	DÉSIGNATION	UT	CODE	PPHT (€)	ECOPART (€)
571.0090.00	CULOTTE GALVA STD CU 200/2X160 511515	U	2901E.5	120,02	0,02
571.0054.00	CULOTTE GALVA STD CU 200/2X200 533329	U	2901F.3	72,02	0,02

atlantic

ACCESSOIRES DE POSE ET D'ÉTANCHEITE

CG - Collier plat - Sachet de 2



	DÉSIGNATION	UT	CODE	PPHT (€)	ECOPART (€)
571.0005.18	COLLIER PLAT D200 -SACHET2- 523323	U	3108F.2	6,91	0,01
571.0006.00	COLLIER PLAT D315 -SACHET2- 523325	U	0359H.0	8,01	0,01

VENTILATION

DISTRIBUTION D'AIR ET CONDUITS



ACCESSOIRE RESEAUX

Registre isolé motorisable - Avec manchon acier + grille alu



	DÉSIGNATION	UT	CODE	PPHT (€)
999.0051.10	REGISTRE ISOLE MOTORISABLE D.160 REIG160	U	225ZX.6	51,10
999.0057.30	REGISTRE ISOLE MOTORISABLE D.200 REIG200	U	2265F.3	57,30



ACCESSOIRE RESEAUX

Plénium ABS - Piquage arrière et réglage de débit - Grilles rectangulaires GSD / GSS



	DÉSIGNATION	UT	CODE	PPHT (€)
999.0039.82	PLENUM ABS SORT.AX. 300X150 PGPA3015	U	229MU.1	39,82
999.0044.77	PLENUM ABS SORT.AX. 400X150 PGPA4015	U	229MV.9	44,77



ACCESSOIRE RESEAU

Raccord - Pour gaine accordéon - Aluminium



	DÉSIGNATION	UT	CODE	PPHT (€)
655.0005.73	RACCORD ALU 125X131 454125	U	78571.7	8,18



ACCESSOIRE RESEAU

Rosace - Pour gaine accordéon - Aluminium



	DÉSIGNATION	UT	CODE	PPHT (€)
655.0007.69	ROSACE ALU / GAINÉ FLEX 110-116 791116	U	68566.9	10,98
655.0008.35	ROSACE ALU / GAINÉ FLEX 125-131 791131	U	44880.3	11,93



ubbink

Build smart

ACCESSOIRE

Kit de raccordement horizontal pour Chauffe-eau thermodynamique - Horizontal Ø 160



	DÉSIGNATION	UT	CODE	PPHT (€)	ECOPART (€)
000.0271.80	KIT BALLON THERMO EPE D160 RACC.HOR. 188850	U	4254W.0	339,81	0,06

Le PPHT comprend l'ecopart (€)

VENTILATION

DISTRIBUTION D'AIR ET CONDUITS



CONDUIT CIRCULAIRE RIGIDE
CMS gaine spiralee Galva - Type M0
- Longueur 3 m



	DÉSIGNATION	UT	CODE	PPHT (€)	ECOPART(€)
560.0042.34	GAINÉ GALVA SPIRALE 3M D125 CMS125 904328	U	1586D.2	52,93	
560.0056.15	GAINÉ GALVA SPIRALE 3M D160 CMS160 904264	U	1586E.9	70,19	
560.0075.11	GAINÉ GALVA SPIRALE 3M D200 CMS200 904284	U	1586F.7	93,89	
560.0095.49	GAINÉ GALVA SPIRALE 3M D250 CMS250 904271	U	1726H.4	119,37	0,01
560.0121.09	GAINÉ GALVA SPIRALE 3M D315 CMS315 904265	U	3010D.4	151,37	0,01



CONDUIT CIRCULAIRE RIGIDE
CDV coude 45° Veloduct - Galva à joint



	DÉSIGNATION	UT	CODE	PPHT (€)
560.0013.66	COUDE VELODUCT 45 CDV-125/45 867758	U	3012K.8	17,07
571.0018.00	COUDE VELODUCT 45 CDV-160/45 867759	U	3012L.6	22,50
571.0022.70	COUDE VELODUCT 45 CDV-200/45 867760	U	30132.5	28,37
571.0033.16	COUDE VELODUCT 45 CDV-250/45 867761	U	30134.1	41,45
571.0050.51	COUDE VELODUCT 45 CDV-315/45 867762	U	30137.4	63,14



CONDUIT CIRCULAIRE RIGIDE
CDV coude 90° Veloduct - Galva à joint



	DÉSIGNATION	UT	CODE	PPHT (€)
560.0016.90	COUDE VELODUCT 90 CDV-125/90 867766	U	1587J.9	21,12
560.0024.70	COUDE VELODUCT 90 CDV-160/90 867767	U	15883.2	30,88
560.0034.33	COUDE VELODUCT 90 CDV-200/90 867768	U	1588D.0	42,91
560.0047.29	COUDE VELODUCT 90 CDV-250/90 867769	U	1588E.7	59,11
560.0072.76	COUDE VELODUCT 90 CDV-315/90 867770	U	1588G.3	90,95



CONDUIT CIRCULAIRE RIGIDE
TE équerre 90° Spiracim - Galva



	DÉSIGNATION	UT	CODE	PPHT (€)
571.0012.94	TE EQUERRE 90 ACIER GALVA D80/80 860510	U	0533T.8	16,17
571.0016.20	TE EQUERRE 90 ACIER GALVA D100/100 860512	U	0152D.6	20,25
571.0017.90	TE EQUERRE 90 ACIER GALVA D125/125 860511	U	35267.4	22,37

VENTILATION

DISTRIBUTION D'AIR ET CONDUITS



CONDUIT CIRCULAIRE RIGIDE
TEV té 90° Veloduct - Galva à joint



	DÉSIGNATION	UT	CODE	PPHT (€)
571.0022.31	TE EQUERRE 90 ACIER GALVA D125/125 867774	U	1587D.1	27,89
560.0025.99	TE EQUERRE 90 ACIER GALVA D160/125 866683	U	1587E.8	32,49
560.0031.20	TE EQUERRE 90 ACIER GALVA D160/160 867775	U	1587F.6	39,00
571.0028.91	TE EQUERRE 90 ACIER GALVA D200/125 866684	U	30111.9	36,14
560.0036.54	TE EQUERRE 90 ACIER GALVA D200/160 867776	U	30112.7	45,67
571.0044.22	TE EQUERRE 90 ACIER GALVA D200/200 867777	U	1587G.4	55,28
560.0035.28	TE EQUERRE 90 ACIER GALVA D250/125 866685	U	30113.5	44,10
560.0043.06	TE EQUERRE 90 ACIER GALVA D250/160 867778	U	30118.4	53,83
560.0052.40	TE EQUERRE 90 ACIER GALVA D250/200 867779	U	3011D.3	65,50
571.0061.04	TE EQUERRE 90 ACIER GALVA D250/250 867780	U	1587H.2	76,30
571.0046.19	TE EQUERRE 90 ACIER GALVA D315/125 866686	U	3011E.0	57,74
560.0053.18	TE EQUERRE 90 ACIER GALVA D315/160 867781	U	3011F.8	66,47
571.0064.04	TE EQUERRE 90 ACIER GALVA D315/200 867782	U	3011G.6	80,05
571.0076.35	TE EQUERRE 90 ACIER GALVA D315/250 867783	U	3011H.4	95,44
571.0096.23	TE EQUERRE 90 ACIER GALVA D315/315 867784	U	3011I.2	120,29



CONDUIT CIRCULAIRE RIGIDE
MRTV manchon raccord Veloduct - Galva à joint



	DÉSIGNATION	UT	CODE	PPHT (€)
560.0006.83	MANCHON RACCORD VELODUCT MRTV 125 867855	U	1587I.0	8,54
560.0007.72	MANCHON RACCORD VELODUCT MRTV 160 867856	U	1587K.7	9,65
560.0009.26	MANCHON RACCORD VELODUCT MRTV 200 867857	U	1587L.5	11,58
560.0011.70	MANCHON RACCORD VELODUCT MRTV 250 867858	U	15880.8	14,63
571.0016.82	MANCHON RACCORD VELODUCT MRTV 315 867859	U	3010H.5	21,02



CONDUIT CIRCULAIRE RIGIDE
REDV Veloduct - Réduction conique



	DÉSIGNATION	UT	CODE	PPHT (€)
571.0013.35	REDUCTION CONIQUE VELODUCT REDV125/80 865699	U	3014J.8	16,69
571.0013.04	REDUCTION CONIQUE VELODUCT REDV160/125 867835	U	1586K.8	16,30
571.0018.89	REDUCTION CONIQUE VELODUCT REDV200/125 865686	U	1586L.6	23,61
560.0016.73	REDUCTION CONIQUE VELODUCT REDV200/160 865687	U	15872.5	20,91
571.0025.28	REDUCTION CONIQUE VELODUCT REDV250/160 865688	U	30150.7	31,60
560.0022.03	REDUCTION CONIQUE VELODUCT REDV250/200 865689	U	15874.1	27,54
571.0031.79	REDUCTION CONIQUE VELODUCT REDV315/160 865690	U	30156.4	39,74
571.0031.79	REDUCTION CONIQUE VELODUCT REDV315/200 865691	U	30159.8	39,74
560.0033.37	REDUCTION CONIQUE VELODUCT REDV315/250 866463	U	3015A.5	41,71

Le PPHT comprend l'ecopart (€)

Les tarifs et disponibilités de nos produits peuvent évoluer sans préavis

RICHARDSON

317

VENTILATION

DISTRIBUTION D'AIR ET CONDUITS



CONDUIT CIRCULAIRE FLEXIBLE

GG - Gaine Galva semi-rigide type M0 - Longueur 3 m



	DÉSIGNATION	UT	CODE	PPHT (€)
560.0047.18	GAINÉ SEMI-RIGIDE GALVA 3M D125 GG125 847713	U	3352J.8	58,97
560.0056.87	GAINÉ SEMI-RIGIDE GALVA 3M D160 GG160 847714	U	3352K.6	71,09



CONDUIT CIRCULAIRE FLEXIBLE

GA - Gaine aluminium semi-rigide type M0 - Longueur 3 m



	DÉSIGNATION	UT	CODE	PPHT (€)
571.0021.02	GAINÉ SEMI-RIGIDE ALU 3M D100 GA100 820186	U	3353B.3	26,27
560.0026.74	GAINÉ SEMI-RIGIDE ALU 3M D125 GA125 820190	U	3353D.9	33,42
571.0037.14	GAINÉ SEMI-RIGIDE ALU 3M D160 GA160 820194	U	3353F.4	46,42
571.0042.87	GAINÉ SEMI-RIGIDE ALU 3M D200 GA200 820737	U	3353G.2	53,59
560.0088.32	GAINÉ SEMI-RIGIDE ALU 3M D315 GA315 820758	U	3353I.8	110,40



CONDUIT CIRCULAIRE FLEXIBLE

GP - Gaine PVC souple - Longueur 6 m



	DÉSIGNATION	UT	CODE	PPHT (€)	ECOPART (€)
560.0020.72	GAINÉ SOUPLE PVC GP80 -6M- 810196	U	27786.3	25,90	
560.0025.94	GAINÉ SOUPLE PVC GP100 -6M- 810197	U	4282B.7	32,42	
560.0034.71	GAINÉ SOUPLE PVC GP125 -6M- 810198	U	27797.0	43,39	
560.0036.75	GAINÉ SOUPLE PVC GP160 -6M- 810201	U	5932H.5	45,95	0,01



CONDUIT CIRCULAIRE FLEXIBLE

GP ISO ECOSOFT - Gaine PVC souple isolée - Zéro phtalate - Isolation 25 mm - Longueur 6 m



	DÉSIGNATION	UT	CODE	PPHT (€)	ECOPART (€)
560.0085.62	GAINÉ SPLE ISO.ECOSOFT 25MM D80 LG6M 813920	U	81430.9	107,04	0,01
560.0101.23	GAINÉ SPLE ISO.ECOSOFT 25MM D125 LG6M 813922	U	8143R.7	126,56	0,02
571.0151.33	GAINÉ SPLE ISO.ECOSOFT 25MM D160 LG6M 813924	U	8143U.0	189,18	0,02

VENTILATION

DISTRIBUTION D'AIR ET CONDUITS



CONDUIT CIRCULAIRE FLEXIBLE

GP PRO - Gaine PVC souple - Conditionnements spéciaux - Longueur 20 m



	DÉSIGNATION	UT	CODE	PPHT (€)	ECOPART (€)
571.0077.77	GAINÉ SOUPLE PVC GP PRO D80 L20M -BTE 811503	U	179SZ.9	97,23	0,02
571.0113.48	GAINÉ SOUPLE PVC GP PRO D125 L20M -BTE 811507	U	179T0.8	141,87	0,02



CONDUIT CIRCULAIRE FLEXIBLE

Gaine souple isolée - Gainable habitat Ecosoft - Isolation 25 mm - Longueur 10 m



	DÉSIGNATION	UT	CODE	PPHT (€)	ECOPART (€)
571.0072.70	GAINÉ SPLE ISO.160MM 25MM-10M-ECOSOFT 810803	U	327J7.2	91,00	0,13
571.0092.12	GAINÉ SPLE ISO.200MM 25MM-10M-ECOSOFT 810804	U	327J8.0	115,32	0,17
571.0120.02	GAINÉ SPLE ISO.250MM 25MM-10M-ECOSOFT 810805	U	327J9.8	150,23	0,21



CONDUIT CIRCULAIRE FLEXIBLE

Gaine souple isolée - Gainable habitat Ecosoft - Isolation 50 mm - Longueur 10 m



	DÉSIGNATION	UT	CODE	PPHT (€)
571.0167.40	GAINÉ SPLE ISO.160MM 50MM-10M-ECOSOFT 810813	U	335HA.0	167,40
571.0213.54	GAINÉ SPLE ISO.200MM 50MM-10M-ECOSOFT 810814	U	335HB.8	213,54
571.0262.68	GAINÉ SPLE ISO.250MM 50MM-10M-ECOSOFT 810815	U	335HC.6	262,68



CONDUIT RECTANGULAIRE RIGIDE

TUB-PLA - PVC ultraplats - Manchon circulaire



	DÉSIGNATION	UT	CODE	PPHT (€)
571.0006.58	MANCHON RACCORD PVC MRT 80P 867682	U	13750.5	8,23



ACCESSOIRES RESEAU

TUB-PLA réduction - PVC



	DÉSIGNATION	UT	CODE	PPHT (€)
560.0003.18	REDUCTION CONIQUE PLASTIQUE 100/80 860407	U	4764F.5	3,98

Le PPHT comprend l'ecopart (€)

VENTILATION

DISTRIBUTION D'AIR ET CONDUITS



ACCESSOIRES RESEAU

TUB-PLA réduction - PVC
- suite



	DÉSIGNATION	UT	CODE	PPHT (€)
560.0003.96	REDUCTION CONIQUE PLASTIQUE 125/100 860408	U	4764I.9	4,95
560.0004.78	REDUCTION CONIQUE PLASTIQUE 150/125 860409	U	7445C.2	5,97
571.0005.21	REDUCTION CONIQUE PLASTIQUE 160/125 863015	U	184YF.0	6,51



ACCESSOIRES RESEAU

MRT manchon raccord Spiraclim - Galva - Mâle



	DÉSIGNATION	UT	CODE	PPHT (€)
560.0003.43	MANCHON RACCORD MALE GALVA MRT 80 860355	U	3525I.1	4,29
560.0003.58	MANCHON RACCORD MALE GALVA MRT 100 860352	U	13753.9	4,47
560.0003.76	MANCHON RACCORD MALE GALVA MRT 125 860353	U	13754.7	4,70
560.0004.08	MANCHON RACCORD MALE GALVA MRT 150 860354	U	7421D.8	5,10
560.0004.04	MANCHON RACCORD MALE GALVA MRT 160 860596	U	3525J.0	5,05
560.0004.69	MANCHON RACCORD MALE GALVA MRT 200 860712	U	3525K.8	5,86
560.0005.86	MANCHON RACCORD MALE GALVA MRT 250 860731	U	3525L.6	7,33



ACCESSOIRES RESEAU

FRT manchon raccord Spiraclim - Galva - Femelle



	DÉSIGNATION	UT	CODE	PPHT (€)
560.0004.04	MANCHON RACCORD FEMELLE FRT160 863909	U	1727C.4	5,05
560.0004.69	MANCHON RACCORD FEMELLE FRT200 863911	U	1727D.2	5,86
560.0005.86	MANCHON RACCORD FEMELLE FRT250 863912	U	1727E.9	7,33



ACCESSOIRES RESEAU

PE piquage express 90° Spiraclim - Galva



	DÉSIGNATION	UT	CODE	PPHT (€)
571.0005.58	PIQUAGE EXPRESS 90 GALVA 125-125 864499	U	35280.7	6,97
571.0005.58	PIQUAGE EXPRESS 90 GALVA 160-125 864989	U	6755L.0	6,97
571.0008.17	PIQUAGE EXPRESS 90 GALVA 200-160 865318	U	4072R.1	10,21
571.0011.07	PIQUAGE EXPRESS 90 GALVA 250-200/90 864390	U	185UF.1	13,84

VENTILATION

DISTRIBUTION D'AIR ET CONDUITS



ACCESSOIRES RESEAU

RED réduction conique Spiraclim - Galva



	DÉSIGNATION	UT	CODE	PPHT (€)
560.0011.64	REDUCTION CONIQUE GALVA RED200/160 860701	U	35279.9	14,55
560.0015.32	REDUCTION CONIQUE AC.GALVA 250/200 860727	U	9482J.8	19,15



ACCESSOIRES DE POSE ET D'ETANCHEITE

CSU - Collier de support isolé - Double filetage
- Fixation sur tige Ø 8 ou 10 mm



	DÉSIGNATION	UT	CODE	PPHT (€)
560.0010.00	COLLIER SUPPORT ISOLE CSU125 867742	U	3527H.1	12,50
560.0010.54	COLLIER SUPPORT ISOLE CSU160 867743	U	3527I.9	13,18
560.0012.93	COLLIER SUPPORT ISOLE CSU200 867744	U	3527J.8	16,16
560.0013.94	COLLIER SUPPORT ISOLE CSU250 867745	U	3527K.6	17,43
560.0016.48	COLLIER CSU ISOLE CSU315 867746	U	71413.9	20,60



ACCESSOIRES DE POSE ET D'ETANCHEITE

COF - Collier de serrage fixe



	DÉSIGNATION	UT	CODE	PPHT (€)
560.0009.62	COLLIER FIL 80 COF80 -SACHET DE 4- 860107	U	87284.6	12,03
560.0010.28	COLLIER FIL 100 COF100 -SACHET DE 4- 860101	U	3527F.5	12,85
560.0005.63	COLLIER FIL 125 COF125 -SACHET DE 2- 860103	U	87288.7	7,04



ACCESSOIRES DE POSE ET D'ETANCHEITE

COF - Collier de serrage réglable



	DÉSIGNATION	UT	CODE	PPHT (€)
560.0009.29	COLLIER SERRAGE CX125 -2- 860097	U	6576L.7	11,61
560.0010.90	COLLIER SERRAGE CX215 -2- 860099	U	24616.3	13,63



ACCESSOIRES DE POSE ET D'ETANCHEITE

Bande perforée - Acier



	DÉSIGNATION	UT	CODE	PPHT (€)
560.0045.34	BANDE PERFOREE L25M EP.8MM TROUS 8MM 865298	U	188V0.7	56,67

VENTILATION

DISTRIBUTION D'AIR ET CONDUITS



ACCESSOIRES GALVA

Piquage VMC - Oblong



	DÉSIGNATION	UT	CODE	PPHT (€)	ECOPART (€)
025.0012.13	PIQUAGE OBLONG GALVA 160 P0160 OBLONG160GALVA	U	335GZ.3	16,17	
025.0012.64	PIQUAGE OBLONG GALVA 200 P0200 OBLONG200GALVA	U	335H0.2	16,85	
025.0013.69	PIQUAGE OBLONG GALVA 250 P0250 OBLONG250GALVA	U	335H1.0	18,25	

BOUCHES ET ENTREE D'AIR

atlantic

BOUCHE D'EXTRACTION ET D'INSUFFLATION REGLABLE

Bouche Design Line - VMC Pavillonnaire - Fixe - Manchon court



	DÉSIGNATION	UT	CODE	PPHT (€)	ECOPART (€)
572.0015.12	BOUCHE FIX.UNIV.LINE PB 80 LINE 80 412219	U	796Z0.1	25,21	0,01
572.0023.55	BOUCHE EXTRACT.UNIV.LINE FIXE D125 LNP 412227	U	796Z2.7	31,42	0,02

atlantic

BOUCHE D'EXTRACTION AUTOREGLABLE

PB - Sanitaire - Bouche fixe - Manchon court pour paroi mince - Longueur 100 mm



	DÉSIGNATION	UT	CODE	PPHT (€)	ECOPART (€)
572.0008.64	BOUCHE EXTRACT.FIXE MANCHON PB 80NP 422147	U	471Z4.3	10,81	0,01

atlantic

BOUCHE D'EXTRACTION AUTOREGLABLE

KIT BAW - Sanitaire



	DÉSIGNATION	UT	CODE	PPHT (€)	ECOPART (€)
572.0055.92	KIT TWIST&GO +BCHE AUTO WC 5-30 PILES 526595	U	9056L.0	93,37	0,17

atlantic

BOUCHE D'EXTRACTION HYGROREGLABLE

BHB/BHC/BHBW - Pack - BHB - Twist&Go



	DÉSIGNATION	UT	CODE	PPHT (€)	ECOPART (€)
572.0039.24	KIT TWIST&GO +BCHE HYGRO SDB 10/40 542576	U	9088V.3	65,43	0,03

VENTILATION

BOUCHES ET ENTREE D'AIR

atlantic

BOUCHE D'EXTRACTION HYGROREGLABLE

BHB/BHC/BHBW - Pack - BHBW - Twist&Go



	DÉSIGNATION	UT	CODE	PPHT (€)	ECOPART (€)
572.0076.20	KIT TWIST&GO +BCHE HYGRO SDB/WC 15/45 526586	U	191E9.3	127,17	0,17

atlantic

BOUCHE D'EXTRACTION HYGROREGLABLE

BHPC/BHC Hygroreglable - Application individuelle - Cuisine - Débit permanent ou hygroregulé - A piles



	DÉSIGNATION	UT	CODE	PPHT (€)	ECOPART (€)
572.0097.50	BOUCHE HYGRO CUIS.BHC 10/45-135 POUSS. 542569	U	92878.8	130,17	0,17

atlantic

ENTREE D'AIR AUTOREGLABLE

Petite entaille - Montage sur menuiserie - Application individuelle - Kit complet



	DÉSIGNATION	UT	CODE	PPHT (€)	ECOPART (€)
572.0003.60	ENTREE AIR AUTO MINI 15 EAM 15+G-35 BL 423139	U	71590.4	6,01	0,01

atlantic

ENTREE D'AIR HYGROREGLABLE

EB - Compact



	DÉSIGNATION	UT	CODE	PPHT (€)	ECOPART (€)
572.0027.45	ENTREE AIR HYGR.COMP. EHC 5/45+G-34 BL 526602	U	170L7.4	36,61	0,01

atlantic

ACCESSOIRES

Manchon de raccordement



	DÉSIGNATION	UT	CODE	PPHT (€)	ECOPART (€)
572.0003.15	MANCHON DE RACCORDEMENT MR80 422232	U	10461.2	4,21	0,01

Le PPHT comprend l'ecopart (€)

VENTILATION

BOUCHES ET ENTREE D'AIR

atlantic

ACCESSOIRES

RCP - Réduction concentrique plastique



	DÉSIGNATION	UT	CODE	PPHT (€)	ECOPART (€)
572.0003.60	REDUCTEUR CONC.RCP 160/125 422809	U	3452N.9	6,01	0,01



BOUCHE D'EXTRACTION REGLABLE

BDO design - Pour VMC Idéo - Manchette à griffe



	DÉSIGNATION	UT	CODE	PPHT (€)
560.0021.99	BOUCHE EXTR.PL/INSUF.DESIGN BDOP 80MM 855015	U	5154G.8	27,49
560.0024.99	BOUCHE EXTR.PL/INSUF.DESIGN BDOP 125MM 855016	U	5154H.6	31,24
571.0051.22	BOUCHE EXTR.PL/INSUF.DESIGN BDOP 160MM 855017	U	2650Y.0	64,02
571.0032.62	BOUCHE EXTR.PL/INSUF.DESIGN BDOP 100MM 855019	U	202R6.7	40,77



BOUCHE D'EXTRACTION AUTOREGLABLE

BAR ALIZEE autoréglable - Pour individuel, collectif ou tertiaire - Manchette à joint Ø 125 mm



	DÉSIGNATION	UT	CODE	PPHT (€)
560.0020.94	BOUCHE AUTO A JOINT BARJ 15 851908	U	2936L.1	26,18
560.0021.34	BOUCHE AUTO A JOINT BARJ 30 851909	U	2937D.6	26,68
560.0021.34	BOUCHE AUTO A JOINT BARJ 45 851912	U	2937E.3	26,68
571.0021.34	BOUCHE AUTO A JOINT BARJ 60 851913	U	2937G.9	26,68



BOUCHE D'EXTRACTION AUTOREGLABLE

BAR ALIZEE autoréglable - Pour individuel, collectif ou tertiaire - Manchette placo 3 griffes



	DÉSIGNATION	UT	CODE	PPHT (€)
560.0020.50	BOUCHE AUTO D125 45M3/H 854366	U	73801.3	25,62
560.0020.50	BOUCHE AUTO D125 60M3/H 850462	U	1726J.1	25,62
560.0020.50	BOUCHE AUTO D125 90M3/H 850503	U	1726L.7	25,62

VENTILATION

BOUCHES ET ENTREE D'AIR



BOUCHE D'EXTRACTION AUTOREGLABLE

BAR ALIZEE autoréglable - Pour individuel, collectif ou tertiaire - Manchette placo



	DÉSIGNATION	UT	CODE	PPHT (€)
560.0022.38	BOUCHE AUTO ALIZEE D125 15M3/H 856522	U	75051.6	27,98
560.0020.50	BOUCHE AUTO ALIZEE D125 30M3/H 856523	U	00031.8	25,62



BOUCHE D'EXTRACTION HYGROREGLABLE

BEH ALIZEE - Pour habitat individuel - WC - Ø 80 mm - Pile + détection de présence



	DÉSIGNATION	UT	CODE	PPHT (€)
560.0075.20	BOUCHE HYGRO WC PILES 5/30M3/H 80MM 858322	U	56062.3	94,00
571.0075.20	BOUCHE HYGRO WC PILES 5/30M3/H 125MM 858323	U	65282.6	94,00



BOUCHE D'EXTRACTION HYGROREGLABLE

BEH ALIZEE - Pour habitat individuel - Salle de bains - Ø 80 mm - Modulation suivant humidité



	DÉSIGNATION	UT	CODE	PPHT (€)
000.0072.37	BOUCHE HYGRO SDB 5/40 80MM 854444	U	56004.5	90,46
560.0072.37	BOUCHE HYGRO SDB 10/40 80MM 850195	U	35071.3	90,46



BOUCHE D'EXTRACTION HYGROREGLABLE

BEH ALIZEE - Pour habitat collectif - Salle de bains - Ø 125 mm - Modulation suivant humidité



	DÉSIGNATION	UT	CODE	PPHT (€)
560.0072.38	BOUCHE HYGRO SDB 10/40 125MM 850196	U	54638.2	90,47



ENTREE D'AIR AUTOREGLABLE

ECA - Acoustique



	DÉSIGNATION	UT	CODE	PPHT (€)
560.0019.80	ENTREE D'AIR ACOUST.ECA 30 BLC 854093	U	1588L.4	24,75
560.0022.07	ENTREE D'AIR ACOUST.ECA 45 BLC 854096	U	15892.3	27,59

Le PPHT comprend l'ecopart (€)

VENTILATION

BOUCHES ET ENTREE D'AIR



REGULATEUR DE DEBIT

RDR - Régulateurs de débit basse pression



	DÉSIGNATION	UT	CODE	PPHT (€)
571.0024.33	REGULATEUR DEB.REG.50-250 D125 30M3/H 852916	U	5918S.4	30,41
560.0024.32	REGULATEUR DEB.REG.50-250 D125 45M3/H 852917	U	1415I.8	30,40
560.0024.32	REGULATEUR DEB.REG.50-250 D125 60M3/H 852919	U	8348H.7	30,40
560.0035.82	REGULATEUR DEB.REG.50-250 D160 50M3/H 852936	U	396K3.5	44,77
560.0035.82	REGULATEUR DEB.REG.50-250 PA D160 852939	U	8500J.8	44,78
560.0035.82	REGULATEUR DEB.REG.50-250 PA D160 852940	U	6560S.3	44,78

EXTRACTEUR INDEPENDANT

atlantic

EXTRACTION INTERMITTENTE

Série Curv Flash



	DÉSIGNATION	UT	CODE	PPHT (€)	ECOPART (€)
574.0103.80	EXTRACTEUR IND. CURV FLASH 100 T D100 123243	U	238PF.3	173,83	0,83
574.0149.25	EXTRACTEUR INDIV.CURV FLASH 100HY 123244	U	232WE.1	199,83	0,83

atlantic

EXTRACTION INTERMITTENTE

Série VCO - Pour conduit court - Mise en route et arrêt par interrupteur



	DÉSIGNATION	UT	CODE	PPHT (€)	ECOPART (€)
574.0045.66	VENTILATEUR INDIV.INTERM. VCO 100 D100 123097	U	92189.0	76,27	0,17

atlantic

EXTRACTION PERMANENTE

Série Curv Confort



	DÉSIGNATION	UT	CODE	PPHT (€)	ECOPART (€)
574.0103.80	EXTRACTEUR IND.CURV CONFORT 100 D100 123235	U	235HQ.2	173,83	0,83
574.0145.80	EXTRACTEUR IND.CURV CONFORT 100HY 123237	U	235HP.4	243,83	0,83

VENTILATION

EXTRACTEUR INDEPENDANT

atlantic

EXTRACTION PERMANENTE

Série Curv Genius



	DÉSIGNATION	UT	CODE	PPHT (€)	ECOPART (€)
574.0163.80	EXTRACTEUR INDIV.CURV GENIUS 100IH 123239	U	238PA.4	273,83	0,83
574.0171.60	EXTRACTEUR IND.CURV GENIUS 120 IH D120 123250	U	238PM.0	286,83	0,83

atlantic

EXTRACTION PERMANENTE

Série VCM Easy



	DÉSIGNATION	UT	CODE	PPHT (€)	ECOPART (€)
574.0118.80	VENTILATEUR COND.VCM EASY D100 315M3/H 123186	U	07031.8	198,83	0,83
574.0211.20	VENTILATEUR COND.VCM EASY D125 328M3/H 123187	U	0384V.3	264,83	0,83

atlantic

ACCESSOIRES

Volet - Protection anti-vent - Volet automatique extérieur



	DÉSIGNATION	UT	CODE	PPHT (€)	ECOPART (€)
574.0010.56	VOLET AUTOMATIQUE EXTERIEURE SM125 123075	U	49547.3	17,61	0,01

atlantic

ACCESSOIRES

Traversée de mur - KTM100



	DÉSIGNATION	UT	CODE	PPHT (€)	ECOPART (€)
574.0043.50	KIT TRAVERSEE MUR KTM 100 D100 123045	U	164DB.6	72,54	0,04

Axelair
VENTILATION

EXTRACTION INTERMITTENTE

Série Evo - Ultra-silencieux - Très basse consommation



	DÉSIGNATION	UT	CODE	PPHT (€)	ECOPART (€)
560.0153.83	EXTRACTEUR HELI MUR.TEMPO HY.100 95 XETPH100	U	7716R.6	205,94	0,83

Le PPHT comprend l'ecopart (€)

VENTILATION

EXTRACTEUR INDEPENDANT



SILENT

Aérateur axial ultra silencieux - Série 100 et 200



	DÉSIGNATION	UT	CODE	PPHT (€)	ECOPART(€)
560.0089.46	AERATEUR SILENT 100 CLAP.ANTI-R 95M3/H 402884	U	4778B.8	112,65	0,83
560.0134.18	AERATEUR SILENT 100 TEMPO REGL. 95M3/H 402885	U	4781B.3	168,55	0,83
560.0161.82	AERATEUR SILENT 100 HYGR.REGL. 95M3/H 402886	U	4784B.0	203,11	0,83



SILENT

Aérateur axial ultra silencieux - Série 100 et 200 Design



	DÉSIGNATION	UT	CODE	PPHT (€)	ECOPART(€)
560.0093.94	AERATEUR SILENT DESIGN 100 CNR 85M3/H 403500	U	3983D.7	118,25	0,83
560.0140.85	AERATEUR SILENT DESIGN 100 TEMP.85M3/H 403501	U	3983E.4	176,89	0,83
560.0169.93	AERATEUR SILENT DESIGN 100 HYGR.85M3/H 403502	U	3983F.2	213,24	0,83



SILENT DUAL

Aérateur intelligent - double détection hygrométrique et présence



	DÉSIGNATION	UT	CODE	PPHT (€)	ECOPART(€)
571.0175.90	AERATEUR SILENT DUAL 100 90M3/H D100 402700	U	245GJ.4	220,70	0,83



TD-MIXVENT

Extracteur de conduit - Ultra-silencieux - 3 vitesses



	DÉSIGNATION	UT	CODE	PPHT (€)	ECOPART(€)
560.0148.48	EXTRACTEUR MIXVENT 3 VIT.150/180 100MM 250454	U	13973.3	186,43	0,83



ACCESSOIRES

MIXVENT-TD - Pour extracteurs de conduits circulaires - Manchette souple



	DÉSIGNATION	UT	CODE	PPHT (€)	ECOPART(€)
571.0055.20	MANCHETTE SOUPLE 400/2H D.125 972414	U	1463B.4	69,00	

Le PPHT comprend l'ecopart (€)

100% EXPO



Faites de nos salles Expo vos outils de vente

- Des espaces dédiés à la Salle de Bains et au Carrelage
- Les dernières tendances
- Des conseillers pour accompagner vos clients dans leur projet

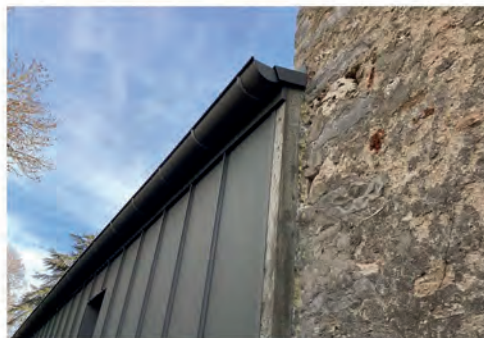
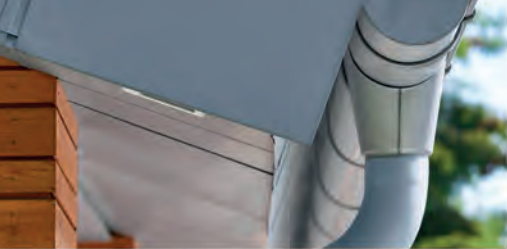

ÉVACUATION DES EAUX PLUVIALES EN ZINC

Une gamme adaptée à chaque chantier pour une fonctionnalité et une esthétique qui dure.

Retrouvez une gamme complète de systèmes d'évacuation des eaux pluviales en zinc RHEINZINK pour toits en pente ou toitures plates. Gouttières, équerres, naissances, tuyaux de descente... vous disposez de tous les produits et accessoires nécessaires pour évacuer de manière sûre et esthétique les eaux de ruissellement des toits jusqu'au sol.

Les diverses teintes disponibles vous permettront de trouver la nuance la plus harmonieuse pour une intégration parfaite dans l'ensemble du bâti. Et pour s'adapter à chaque chantier, vous avez le choix entre de multiples formes et dimensions correspondant aux spécificités régionales.

Pour en savoir plus, rendez-vous sur notre site internet :

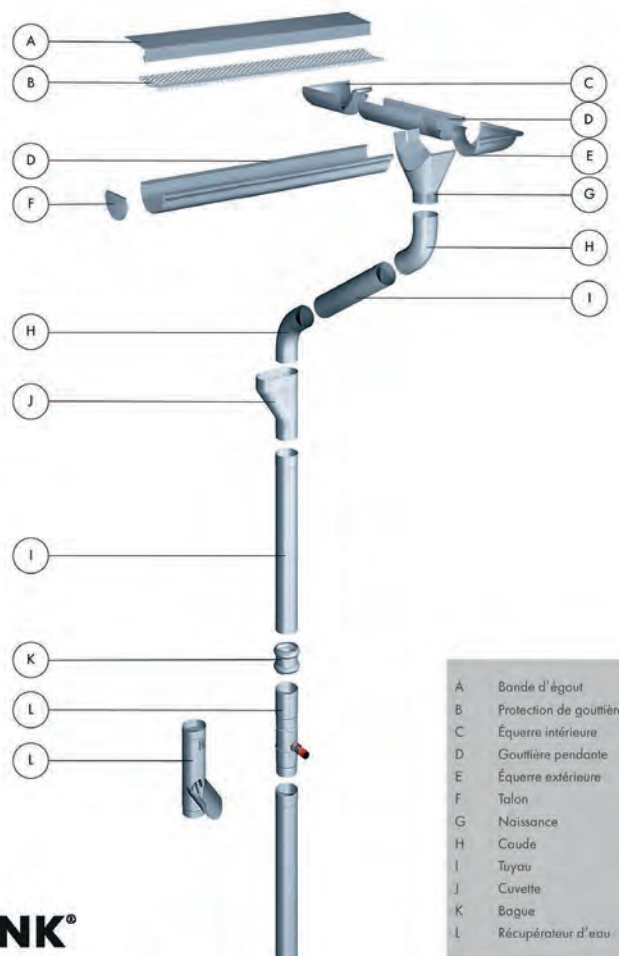

- A Bande d'égout
- B Protection de gouttière
- C Équerre intérieure
- D Gouttière pendante
- E Équerre extérieure
- F Talon
- G Naissance
- H Coude
- I Tuyau
- J Cuvette
- K Bague
- L Récupérateur d'eau



Retrouvez plus d'information et d'inspiration sur www.rheinzink.fr

RHEINZINK FRANCE SAS · 796 Rue de la République · 42590 Neulise · France · Tél. : +33 4 77 66 42 90 · contact@rheinzink.fr

Couverture

SOMMAIRE

COUVERTURE ET ZINGUERIE

SELECTION ZINC	326
SELECTION FONTE	327
SELECTION GALVA	327
SELECTION PVC A COLLER	328
SELECTION AUTRES	330

COUVERTURE ET ZINGUERIE

SELECTION ZINC



FEUILLE

Zinc naturel



	DÉSIGNATION	UT	CODE	PPHT (€)
167.0125.59	FEUILLE DE ZINC N 14 0.80X2000X1000	U	73280.0	167,45



GOUTTIERE

Lyonnaise - ABA



	DÉSIGNATION	UT	CODE	PPHT (€)
167.0010.78	GOUTTIERE ZINC LYONNAISE ABA 4M B18 25X0.65	M	83431.7	14,37
167.0021.26	GOUTTIERE ZINC LYONNAISE ABA 2M B18 33X0.65	M	97459.2	28,35
167.0019.88	GOUTTIERE ZINC LYONNAISE ABA 4M B18 33X0.65	M	41305.4	26,50



NAISSANCE

Droite à souder



	DÉSIGNATION	UT	CODE	PPHT (€)
174.0004.24	NAISSANCE DROITE DE ZINC 25/80	U	01198.1	5,65
174.0004.95	NAISSANCE DROITE DE ZINC 33/100	U	01199.9	6,60



NAISSANCE

Agrafable



	DÉSIGNATION	UT	CODE	PPHT (€)
174.0011.85	NAISSANCE AGRAFABLE EN ZINC 25/80	U	17738.6	15,80
174.0013.22	NAISSANCE AGRAFABLE EN ZINC 33/80	U	57026.7	17,63
174.0011.09	NAISSANCE AGRAFABLE EN ZINC 33/100	U	74200.7	14,79



COUDE

Soudé étain "PARIS"



	DÉSIGNATION	UT	CODE	PPHT (€)
174.0006.74	COUDE ZINC SOUDE 72 DEGRES 80	U	18842.5	8,98
174.0006.60	COUDE ZINC SOUDE 72 DEGRES 100	U	18847.4	8,80

COUVERTURE ET ZINGUERIE

SELECTION ZINC



COUDE

Lyonnais



	DÉSIGNATION	UT	CODE	PPHT (€)
174.0005.65	COUDE LYONNAIS DE ZINC 80	U	01188.2	7,53
174.0004.90	COUDE LYONNAIS DE ZINC 100	U	01189.0	6,53



CUVETTE

1/2 ronde de face



	DÉSIGNATION	UT	CODE	PPHT (€)
174.0051.04	CUVETTE ZINC 1/2 RONDE DE FACE 80	U	01191.6	68,05
174.0041.82	CUVETTE ZINC 1/2 RONDE DE FACE 100	U	01192.4	55,76



CUVETTE

1/2 ronde d'angle



	DÉSIGNATION	UT	CODE	PPHT (€)
174.0063.86	CUVETTE ZINC 1/2 RONDE D ANGLE 100	U	01195.7	85,15



CUVETTE

Jambon



	DÉSIGNATION	UT	CODE	PPHT (€)
174.0023.13	CUVETTE ZINC BRANCHEMENT MEPLATE 80	U	17875.6	30,84
174.0027.71	CUVETTE ZINC BRANCHEMENT MEPLATE 100	U	17873.1	36,95



FOND

Talon



	DÉSIGNATION	UT	CODE	PPHT (€)
174.0002.80	TALON ZINC DE GOUTTIERE 25	U	01179.1	3,73
174.0001.87	TALON ZINC DE GOUTTIERE 33	U	01180.9	2,49

COUVERTURE ET ZINGUERIE

SELECTION ZINC



FOND

Talon - Agrafable



	DÉSIGNATION	UT	CODE	PPHT (€)
174.0002.59	TALON ZINC DE GOUTTIERE AGRAFABLE 25	U	47088.0	3,45
174.0002.42	TALON ZINC DE GOUTTIERE AGRAFABLE 33	U	47102.9	3,23

RHEINZINK® MANCHON



	DÉSIGNATION	UT	CODE	PPHT (€)
174.0009.25	MANCHON ZINC 100 1133452	U	5384V.2	9,25

RHEINZINK® SYSTEME D'EVACUATION DES EAUX PLUVIALES

Tuyau de descente - Soudé zimo



	DÉSIGNATION	UT	CODE	PPHT (€)
167.0049.82	TUYAU ZINC SOUDE ZIMO LG.2M 80	U	44304.4	66,43
167.0048.19	TUYAU ZINC SOUDE ZIMO LG.2M 100	U	44354.9	64,25

SELECTION FONTE



DAUPHIN

Pluviale ronde sans patte - Coudé



	DÉSIGNATION	UT	CODE	PPHT (€)	ECOPART (€)
302.0132.42	PIED DE CHUTE ROND COUDE 1M 100 155640	U	03141.9	176,57	0,01



DAUPHIN

Pluviale ronde sans patte - Droit



	DÉSIGNATION	UT	CODE	PPHT (€)	ECOPART (€)
302.0091.54	DESCENTE DROITE RONDE DN100 -1M- 155595	U	5276K.4	122,07	0,01

Le PPHT comprend l'ecopart (€)

COUVERTURE ET ZINGUERIE

SELECTION GALVA



CRAPAUDINE



	DÉSIGNATION	UT	CODE	PPHT (€)
174.0004.72	CRAPAUDINE GALVA 100	U	01187.4	6,30



COLLIER

De descente - N26 - Embase taraudée



	DÉSIGNATION	UT	CODE	PPHT (€)
174.0002.32	COLLIER G NERV.80 N26 EMB.7X150 260807	U	62648.1	3,10
174.0002.40	COLLIER G NERV.100 N26 EMB.7X150 261007	U	62650.7	3,20
174.0002.40	COLLIER G NERV 110 N26 EMB.7X150 261107	U	53595.5	3,20
174.0003.65	COLLIER G NERV 125 N26 EMB.7X150 261257	U	18101.6	4,87
174.0002.37	COLLIER G NERV 80 N26 EMB.8X125 260808	U	17487.0	3,16
174.0002.44	COLLIER G NERV 100 N26 EMB.8X125 261008	U	73268.5	3,25
174.0009.68	COLLIER G NERV 120 N26 EMB.8X125 261208	U	1884B.5	12,90
174.0003.65	COLLIER G NERV 125 N26 EMB.8X125 261258	U	77810.0	4,87
174.0004.18	COLLIER G NERV 140 N26 EMB.8X125 261408	U	98090.4	5,58
174.0004.24	COLLIER G NERV 160 N26 EMB.8X125 261608	U	46662.3	5,65
174.0004.66	COLLIER G NERV 200 N26 EMB.8X125 262008	U	31753.7	6,21
174.0006.41	COLLIER G NERV 250 N26 EMB.8X125 262508	U	46663.1	8,55
174.0007.31	COLLIER G NERV 315 N26 EMB.8X125 263158	U	4666A.5	9,75



CROCHET

Embouti - Berceau paillette rapportée dos nervuré galvanisé



	DÉSIGNATION	UT	CODE	PPHT (€)
174.0001.21	CROCHET EMBOUTI DOS NERVURE GALVA G6BNP25	U	11100.5	1,61
174.0001.04	CROCHET EMBOUTI DOS NERVURE GALVA G6BNP3318	U	11112.0	1,39



CROCHET

Toulon chantourné - A bâtir



	DÉSIGNATION	UT	CODE	PPHT (€)
174.0004.04	CROCHET TOULON GALVA CHANT.A BATIR G8CB25	U	47990.7	5,38
174.0004.40	CROCHET TOULON GALVA CHANT.A BATIR G8CB33	U	47991.5	5,86

COUVERTURE ET ZINGUERIE

SELECTION GALVA



CROCHET

Toulon chantourné - A clouer



	DÉSIGNATION	UT	CODE	PPHT (€)
174.0003.56	CROCHET TOULON GALVA CHANT.A CLOUER G8TCC33	U	47993.1	4,74



TIRANT

Marseillais



	DÉSIGNATION	UT	CODE	PPHT (€)
174.0005.66	TIRANT GALVA MARSEILLAIS LG.400MM G1640	U	52146.8	7,54



ACCESSOIRES DE POSE

Pince réglable feuillard plat - Avec plaquette



	DÉSIGNATION	UT	CODE	PPHT (€)
174.0005.06	PINCE REGLABLE FEUILLARD PLAT TUILLE G6PETUILLE	U	2074C.1	6,75

SELECTION PVC A COLLER



COLLIER

De descente - A bride PVC



	DÉSIGNATION	UT	CODE	PPHT (€)
257.0002.41	COLLIER A BRIDE PVC SABLE 80	U	41883.0	4,02
257.0004.18	COLLIER A BRIDE PVC GRIS 100	U	78924.8	5,58
257.0004.18	COLLIER A BRIDE PVC SABLE 100	U	61569.0	5,58
257.0003.03	COLLIER A BRIDE PVC BLANC 100	U	2030A.7	5,05



COUDE

FF - 45°



	DÉSIGNATION	UT	CODE	PPHT (€)
257.0010.28	COUDE GOUTTIERE 45.PVC FF SABLE 80	U	07447.6	13,71
257.0019.61	COUDE GOUTTIERE 45.PVC FF SABLE 100	U	06194.5	26,15

COUVERTURE ET ZINGUERIE

SELECTION PVC A COLLER



COUDE

FF - 87°30



	DÉSIGNATION	UT	CODE	PPHT (€)
257.0010.76	COUDE GOUTTIERE 87.30 PVC FF SABLE 80	U	07448.4	14,35
257.0020.62	COUDE GOUTTIERE 87.30 PVC FF SABLE 100	U	06197.8	27,49



COUDE

MF - 45°



	DÉSIGNATION	UT	CODE	PPHT (€)
257.0008.92	COUDE GOUTTIERE 45.PVC MF SABLE 80	U	41881.4	11,89
257.0017.04	COUDE GOUTTIERE 45.PVC MF SABLE 100	U	61566.6	22,72
257.0013.02	COUDE GOUTTIERE 45.PVC MF GRIS 100	U	20309.0	17,36



COUDE

MF - 67°30



	DÉSIGNATION	UT	CODE	PPHT (€)
257.0017.04	COUDE GOUTTIERE 67.30 PVC MF SABLE 100	U	61567.4	22,72



COUDE

MF - 87°30



	DÉSIGNATION	UT	CODE	PPHT (€)
257.0009.38	COUDE GOUTTIERE 87.30 PVC MF SABLE 80	U	41885.5	12,51
257.0017.90	COUDE GOUTTIERE 87.30 PVC MF GRIS 100	U	23767.7	23,86
257.0017.90	COUDE GOUTTIERE 87.30 PVC MF SABLE 100	U	61568.2	23,86



CROCHET

Bandeau plastique - Pour demi-gouttière ronde de 25



	DÉSIGNATION	UT	CODE	PPHT (€)
257.0002.86	CROCHET BANDEAU GOUT.A COLLER PVC SABLE 25	U	41880.6	3,82

COUVERTURE ET ZINGUERIE

SELECTION PVC A COLLER



CROCHET

Bandeau plastique - Pour demi-gouttière ronde de 33



	DÉSIGNATION	UT	CODE	PPHT (€)
257.0004.64	CROCHET BANDEAU GOUT.A COLLER PVC SABLE 33	U	61563.3	6,18



CULOTTE

MF - 67°30



	DÉSIGNATION	UT	CODE	PPHT (€)
257.0024.52	CULOTTE GOUTTIERE 67.30 PVC MF SABLE 100	U	18632.0	32,70



GOUTTIERE

Demi-ronde



	DÉSIGNATION	UT	CODE	PPHT (€)
257.0018.36	GOUTTIERE PVC SABLE 33	M	61512.0	24,48



GOUTTIERE

Demi-ronde - 25 - Avec profilé



	DÉSIGNATION	UT	CODE	PPHT (€)
257.0013.36	GOUTTIERE PVC SABLE 25	M	41871.5	17,81



JONCTION



	DÉSIGNATION	UT	CODE	PPHT (€)
257.0004.19	JONCTION A COLLER PVC SABLE 25	U	41873.1	5,59
257.0005.62	JONCTION A COLLER PVC SABLE 33	U	61520.3	7,49

COUVERTURE ET ZINGUERIE

SELECTION PVC A COLLER



MANCHON

FF



	DÉSIGNATION	UT	CODE	PPHT (€)
257.0005.50	MANCHON DOUBLE FEMELLE PVC SABLE 80	U	41882.2	7,33
257.0007.12	MANCHON DOUBLE FEMELLE PVC SABLE 100	U	62530.1	9,50



NAISSANCE



	DÉSIGNATION	UT	CODE	PPHT (€)
257.0014.08	NAISSANCE CENTRALE A COLLER PVC 80 SABLE 25	U	41872.3	18,78
257.0021.04	NAISSANCE CENTRALE A COLLER PVC 100 SABLE 33	U	61514.6	28,05



REDUCTION CONCENTRIQUE

FM - Pour tube de descente ø 80



	DÉSIGNATION	UT	CODE	PPHT (€)
257.0009.76	REDUCTION CONCENTRIQ.FEM100/MALE 80 SABLE	U	20913.0	13,02



TUYAU DE DESCENTE



	DÉSIGNATION	UT	CODE	PPHT (€)
257.0011.32	TUYAU DE DESCENTE PVC SABLE 80	M	41895.4	15,09
257.0014.43	TUYAU DE DESCENTE PVC SABLE 100	M	61564.1	19,24



by aliaxis

FOND DE GOUTTIERE DEMI-RONDE

Symétrique - Pour gouttière demi-ronde LG25 à coller



	DÉSIGNATION	UT	CODE	PPHT (€)
257.0003.67	FOND SYMET.A COLL.LG25 SABLE UFCCG25S	U	91163.6	4,89

COUVERTURE ET ZINGUERIE

SELECTION PVC A COLLER

Nicoll
by aliaxis

FOND DE GOUTTIERE DEMI- RONDE

Symétrique - Pour gouttière demi-ronde LG33 à coller



	DÉSIGNATION	UT	CODE	PPHT (€)	ECOPART (€)
257.0005.60	FOND SYMET.A COLL.LG33 SABLE UFCG33S	U	82179.3	7,46	

Nicoll
by aliaxis

FOND DE NAISSANCE DEMI- RONDE

Symétrique - Pour gouttière demi-ronde LG25 à coller



	DÉSIGNATION	UT	CODE	PPHT (€)	ECOPART (€)
257.0003.67	FOND SYMET.NAISS. LG25 SABLE UFCN25S	U	12763.9	4,89	

Nicoll
by aliaxis

FOND DE NAISSANCE DEMI- RONDE

Symétrique - Pour gouttière demi-ronde LG33 à coller



	DÉSIGNATION	UT	CODE	PPHT (€)	ECOPART (€)
257.0005.60	FOND SYMET.NAISS. LG33 SABLE UFCN33S	U	69377.0	7,46	

Nicoll
by aliaxis

COUDE DEMI- RONDE

FF - 45° - Pour tube de descente ø 100



	DÉSIGNATION	UT	CODE	PPHT (€)	ECOPART (€)
257.0019.60	COUDE 45° TD100 FF BLC UCT446TB	U	1376D.6	26,15	0,01
257.0026.14	COUDE 45° TD100 FF GRIS UCT446T	U	7817K.6	26,15	0,01

Nicoll
by aliaxis

COUDE DEMI- RONDE

FF - 87°30 - Pour tube de descente ø 100



	DÉSIGNATION	UT	CODE	PPHT (€)	ECOPART (€)
257.0020.61	COUDE 87°30 TD100 FF BLC UCT886TB	U	0169F.4	27,49	0,01
257.0027.48	COUDE 87°30 TD100 FF GRIS UCT886T	U	7810D.7	27,49	0,01

COUVERTURE ET ZINGUERIE

SELECTION PVC A COLLER

Nicoll
by aliaxis

CULOTTE DEMI- RONDE

MF - 67°30 - Simple - Pour tube de descente ø 100



	DÉSIGNATION	UT	CODE	PPHT (€)	ECOPART (€)
257.0032.70	CULOTTE 67°30 SIMPLE MF TD100 BLC UBT166TB	U	1375L.1	32,71	0,01

Nicoll
by aliaxis

BOITE A EAU

Pour tube de descente ø 100



	DÉSIGNATION	UT	CODE	PPHT (€)	ECOPART (€)
257.0083.02	BOITE A EAU P.TUBE DESC.100 BLC UBA0100B	U	1376E.3	110,72	0,02

SELECTION AUTRES



CRAPAUDINE

Polypropylène - Extensible



	DÉSIGNATION	UT	CODE	PPHT (€)	ECOPART (€)
257.0008.84	CRAPAUDINE PP 80 ET 100	U	81271.9	11,79	

greensolutions

Votre partenaire énergie



SIMULEZ VOS AIDES EN QUELQUES CLICS



Une seule démarche pour bénéficier de l'ensemble des aides éligibles



Une hotline dédiée vous accompagne dans vos démarches



Chaque dossier est contrôlé pour garantir le paiement des primes



Une facture allégée en déduisant l'ensemble des aides éligibles



Toutes les aides éligibles grâce au simulateur de primes



Toutes les actualités de la rénovation énergétique

Retrouvez chez RICHARDSON les produits éligibles aux aides :



Pompe à chaleur air/eau



Chauffe-eau thermo-dynamique



Poêle à granulés



Chaudière à bois



VMC simple et double flux

www.richardson.fr/services/green-solutions

Hotline

06 27 52 64 95



POUR TOUT COLLER, MONTER ET ÉTANCHER



Avec l'aide des produits de la marque Griffon, vous obtenez toujours le meilleur résultat final. En tant que professionnel, vous pouvez placer toute votre confiance dans ces produits. Initialement, Griffon a développé Poly Max® à base de SMP Polymère pour coller, monter et étancher. Aujourd'hui, grâce aux innovations constantes telles que le développement d'une formule Express très rapide, Poly Max® continue de fournir des prestations de la plus haute efficacité pour un résultat final toujours parfait. Toute la gamme atteint désormais sa résistance finale en seulement 4 heures. Ainsi, le professionnel ne perd pas un temps précieux, car les assemblages qu'il réalise peuvent être sollicités plus rapidement. Vous pouvez dès lors faire confiance à Poly Max® pour coller, monter et étancher au plus haut niveau : SMP Polymer Express pour une résistance finale élevée, High Tack Express pour une prise initiale élevée et Fix & Seal Express pour une élasticité élevée.



**RÉSISTANCE
FINALE APRÈS
4 HEURES**

www.griffonfrance.fr

Griffon. Le choix des pros.

Droguerie Supportage

SOMMAIRE

DROGUERIE

COLLE ET MASTIC	334
ETANCHEITE.....	337
DROGUERIE	340
QUINCAILLERIE	342

SUPPORTAGE ET FIXATION

SUPPORTAGE.....	344
FIXATION	349

DROGUERIE

COLLE ET MASTIC



EXCLUSIVITES RICHARDSON PAR WOLF

Pistolet - Pour cartouche



	DÉSIGNATION	UT	CODE	PPHT (€)
000.0024.43	PISTOLET POUR CARTOUCHE TEKNIK 007209	U	307X5.0	34,90



EXCLUSIVITES RICHARDSON PAR WOLF

Lisseur silicone - 3 pièces



	DÉSIGNATION	UT	CODE	PPHT (€)
000.0012.00	LISSEUR DE JOINTS -3PCS- TEKNIK 106070	U	307X6.8	12,00



ASSEMBLAGE ET COLLAGE

Colle - Pour miroir



	DÉSIGNATION	UT	CODE	PPHT (€)
900.0011.89	COLLE POUR MIROIR CARTOUCHE 310ML	U	57859.1	15,85



ASSEMBLAGE ET COLLAGE

Colle - Pression / évacuation



	DÉSIGNATION	UT	CODE	PPHT (€)
900.0004.38	COLLE PVC PRESSION/EVACUATION TUBE 125ML	U	63148.1	5,84



ASSEMBLAGE ET COLLAGE

Colle - Pression / évacuation - Avec pinceau



	DÉSIGNATION	UT	CODE	PPHT (€)
900.0008.24	COLLE PVC PRESSION/EVAC.-POT+PINCEAU- 0,250L	U	63147.3	10,98
900.0019.12	COLLE PVC PRESSION/EVAC.-POT+PINCEAU- 1L	U	63146.5	25,49

DROGUERIE

COLLE ET MASTIC



ASSEMBLAGE ET COLLAGE

Colle - PVC



	DÉSIGNATION	UT	CODE	PPHT (€)
900.0015.41	COLLE PVC BOITE+PINCEAU 500ML	U	4538K.1	20,55



CIMENT PROMPT



	DÉSIGNATION	UT	CODE	PPHT (€)
000.0012.03	CIMENT PROMPT 5KG	U	00078.6	12,03
000.0020.75	CIMENT PROMPT 10KG	U	85444.8	20,75



MASTIC

Mastic de collage et d'étanchéité spécial couverture en zinc



	DÉSIGNATION	UT	CODE	PPHT (€)
900.0014.02	COLLE MASTIC ZINC 310ML	U	7541P.1	18,70



MASTIC

MS Polymère



	DÉSIGNATION	UT	CODE	PPHT (€)
921.0019.09	MASTIC COLLE MS POLYMERE BLANC CART.BLANC	U	264HA.2	25,45



MORTIER RAPIDE



	DÉSIGNATION	UT	CODE	PPHT (€)
000.0011.02	MORTIER RAPIDE 5KG	U	72347.8	11,02

DROGUERIE

COLLE ET MASTIC



PLATRE BLANC



	DÉSIGNATION	UT	CODE	PPHT (€)
000.0009.99	PLATRE BLANC 5KG	U	45004.9	9,99
000.0015.55	PLATRE BLANC 10KG	U	72349.4	15,55



ACRYBAT BT

Mastic acrylique pour joints en maçonnerie et menuiserie



	DÉSIGNATION	UT	CODE	PPHT (€)
921.0006.78	MASTIC ACRYBAT BT BLANC -CART.310ML- 107050	U	65925.0	7,98



GEBSOPLAST

Décapant - Solvant de nettoyage avant collage du PVC



	DÉSIGNATION	UT	CODE	PPHT (€)
921.0011.14	DECAPANT GEBSOPLAST -BIDON 1L- 805373	U	51990.0	14,86



GEBSOPLAST

HT Plus - Colle évacuation en gel pour raccords en PVC rigide



	DÉSIGNATION	UT	CODE	PPHT (€)
900.0016.47	COLLE GEBSOPLAST HT PLUS -POT 250ML- 504855	U	0067K.8	16,47



COLLAFEU

Colle de fixation pour produits réfractaires fibreux sur des pièces soumises à de fortes températures - Cartouche



	DÉSIGNATION	UT	CODE	PPHT (€)
921.0017.26	COLLE REFRACT.COLLAFEU -CART.310ML- 125252	U	10559.3	20,30

DROGUERIE

COLLE ET MASTIC



DECAPANT UNIVERSEL

Aérosol



	DÉSIGNATION	UT	CODE	PPHT (€)
921.0021.29	DECAPANT UNIVERSEL AEROSOL 400/650 ML 805700	U	7752M.9	21,29



FILGUM

Mastic sanitaire



	DÉSIGNATION	UT	CODE	PPHT (€)
921.0017.73	MASTIC FILGUM -POT 500G- 104012	U	41119.9	20,86



GEBSICONE

W2 - Mastic silicone pour joints sanitaire - Spécial émail et acrylique



	DÉSIGNATION	UT	CODE	PPHT (€)
921.0012.96	MASTIC GEBSICONE W2 BLANC -CART.310ML- 890501	U	57010.1	17,28



POOL

COLLE REPAR SKIMMER



	DÉSIGNATION	UT	CODE	PPHT (€)
900.0007.94	COLLE REPAR SKIMMER PPL 125ML POOL 127297	U	395V8.1	9,92



POOL

Réparation fuite



	DÉSIGNATION	UT	CODE	PPHT (€)
921.0027.41	MASTIC REPARATION FUITES POOL 127261	U	3828H.7	27,41



PISTOLET

Pistolet pour mousse pistolable



	DÉSIGNATION	UT	CODE	PPHT (€)
921.0026.29	PISTOLET POUR MOUSSE PU PISTOLABLE 813282	U	0430T.2	52,59

DROGUERIE

COLLE ET MASTIC



CANULE POUR CARTOUCHE

Silicone 360° - Pour dépose de mastic



	DÉSIGNATION	UT	CODE	PPHT (€)
921.0007.48	CANULE CARTOUCHE 360 -LOT 5- 131402	U	9532R.4	9,98



POLYMERE DE SOUDURE

HTA fusion - Avec applicateur



	DÉSIGNATION	UT	CODE	PPHT (€)
900.0019.66	POLYMERE SOUDURE HTA 250ML+PINCE HTAFUSIONP	U	232PU.8	26,22
900.0057.26	POLYMERE DE SOUDURE HTA 1L+PINCE HTAFUSIONB	U	232JO.9	88,10



AQUA MAX

Colle de montage et mastic d'étanchéité - Spécial piscine



	DÉSIGNATION	UT	CODE	PPHT (€)
900.0016.58	COLLE AQUA MAX SP.PISCINE BLANC 425G 6308214	U	0871K.4	22,11



POLY MAX® FIX & SEAL EXPRESS

Colle de montage et mastic d'étanchéité sans solvants - Séchage rapide



	DÉSIGNATION	UT	CODE	PPHT (€)
921.0017.13	MASTIC COLLE POLYMAX F&S TRANS.C.300G 6150452	U	18552.0	24,47
921.0024.47	MASTIC COLLE POLYMAX F&S.GRIS C.425G 6150456	U	1991L.5	24,47
921.0024.47	MASTIC COLLE POLYMAX F&S.NOIR .C.425G 6150454	U	1991K.7	24,47
921.0024.47	MASTIC COLLE POLYMAX F&S.TERRACO.425G 6310414	U	5788V.4	24,47



POLY MAX® HIGH TACK EXPRESS

Colle de montage sans solvant - Prise initiale très élevée - Séchage rapide - Prise initiale très élevée



	DÉSIGNATION	UT	CODE	PPHT (€)
921.0019.49	COLLE POLYMAX H.TACK EXPRES.CART.BLC 6303764	U	6894V.3	25,99

DROGUERIE

COLLE ET MASTIC



S-100

Mastic silicone sanitaire - Base acétique



	DÉSIGNATION	UT	CODE	PPHT (€)
921.0010.12	MASTIC SILICONE BLANC CART.300ML 1249325	U	68250.0	12,65
921.0010.12	MASTIC SILICONE TRANS.CART.300ML 1249350	U	68246.8	12,65



S-200

Mastic silicone sanitaire - Base neutre- Idéal pour les surfaces acryliques - Qualité alimentaire



	DÉSIGNATION	UT	CODE	PPHT (€)
921.0021.15	MASTIC SILIC.SANIT.S-200 BLANC 300ML 6315507	U	306AW.5	21,15
921.0021.15	MASTIC SILIC.SANIT.S-200 TRANSP.300ML 6315510	U	312B3.1	21,15



WDF-05®

Colle PVC rigide bleue thixotrope à prise très rapide - Spécial piscine et mise en eau rapide - Pot avec pinceau goupillon



	DÉSIGNATION	UT	CODE	PPHT (€)
900.0009.63	COLLE PVC PISCINE WDF-05 250ML+PINC. 6307287	U	6159A.4	12,84



GUN PROFESSIONAL

Pistolet professionnel métal pour cartouche - Avec berceau 360° - Stop goutte - Pro



	DÉSIGNATION	UT	CODE	PPHT (€)
921.0025.75	PISTOLET CARTOUCHE PRO 6307285	U	8086H.3	34,33



COLLE ENDUIT

Tous travaux - pour collage, montage, rebouchage, surfaçage et lissage



	DÉSIGNATION	UT	CODE	PPHT (€)
000.0015.77	COLLE ENDUIT TOUS TRAVAUX -5KG- PAREX. 02806	U	09339.3	15,77
000.0025.26	COLLE ENDUIT TOUS TRAVAUX -10KG- PAREX. 02807	U	1856D.4	25,26

DROGUERIE

ETANCHEITE



MOUSSE EXPANSIVE

Tous sens



	DÉSIGNATION	UT	CODE	PPHT (€)
900.0025.54	MOUSSE EXPANSIVE TOUS SENS 750ML	U	7541M.5	25,54



BANDE DE REPARATION

Bande permettant une réparation durable des fuites, fissures et trous, sur tous les supports rigides



	DÉSIGNATION	UT	CODE	PPHT (€)
921.0015.07	BANDE DE REPARATION 1.5MX5CM -BLISTER- 127400	U	2767N.1	25,12



BOBINO DE FILASSE

Dévidoir - Permettant l'étanchéité des raccords filetés métalliques



	DÉSIGNATION	UT	CODE	PPHT (€)
921.0025.83	FILASSE DE LIN DEVIDOIR -BOBINE 80G- 515030	U	78207.8	30,39
921.0040.01	FILASSE RT1 DEVIDOIR -BOBINE 80G- 515130	U	190U5.3	57,16



GEBAJOINT

Pâte d'étanchéité durcissante pour raccords filetés en chauffage nipples et tuyauteries industrielles



	DÉSIGNATION	UT	CODE	PPHT (€)
921.0013.66	PATE A JOINT GEBAJOINT -POT 500G- 100412	U	13596.2	16,07



FILASSE DE LIN

Filasse de lin



	DÉSIGNATION	UT	CODE	PPHT (€)
921.0010.43	FILASSE DE LIN POUPEE 200GR 815099	U	80975.6	10,43

DROGUERIE

ETANCHEITE



FILEPLAST EAU POTABLE

Pâte d'étanchéité pour raccords filetés plastique/plastique ou plastique/métal



	DÉSIGNATION	UT	CODE	PPHT (€)
921.0042.69	PATE ETANC.FILEPL.EAU POT TUBE 100G 112814	U	50812.7	50,22



RUBAN PTFE

Pour l'étanchéité des raccords filetés - Standard



	DÉSIGNATION	UT	CODE	PPHT (€)
921.0000.94	RUBAN PTFE STD 12X12X0.075MM -10- 815192	U	24680.1	1,26



RUBAN PTFE

Pour l'étanchéité des raccords filetés - Spécial gros diamètre



	DÉSIGNATION	UT	CODE	PPHT (€)
921.0008.06	RUBAN PTFE GROS DIAM.19MMX15MX0.2MM V. 815119	U	83793.0	10,74



OLIFAN

PTFE - Ruban P.T.F.E. pour l'étanchéité des raccords filetés - Oxygène gaz spéciaux vapeur



	DÉSIGNATION	UT	CODE	PPHT (€)
921.0018.80	RUBAN OLIFAN PTFE OXYG.12MMX30MX0.1MM 815202	U	44557.7	25,06



FILJOINT

Fil imprégné pour l'étanchéité des raccords filetés métalliques et plastiques (coniques ou cylindriques)



	DÉSIGNATION	UT	CODE	PPHT (€)
921.0037.75	FIL ETANCHEITE FILJOINT -DEVID.100M- 515100	U	38727.4	37,75

DROGUERIE

ETANCHEITE



GEBATOUT 2

Pâte à joint non durcissante pour raccords filetés métalliques en plomberie et en chauffage



	DÉSIGNATION	UT	CODE	PPHT (€)
921.0013.66	PATE GEBATOUT 2 -TUBE 250G- 103960	U	75295.6	16,07
921.0011.38	PATE GEBATOUT 2 -TUBE 125ML- 103981	U	66862.4	13,39



GEBATOUT 2

Pâte à joint non durcissante pour raccords filetés métalliques en plomberie et en chauffage



	DÉSIGNATION	UT	CODE	PPHT (€)
921.0014.14	PATE GEBATOUT POT 500G -2- 103982	U	66875.6	16,63



GEBATOUT 2

Pâte à joint non durcissante pour raccords filetés métalliques en plomberie et en chauffage - KIT



	DÉSIGNATION	UT	CODE	PPHT (€)
921.0029.05	PATE GEBATOUT 2 +FILASSE -LOT- GEB 203980	U	5251G.0	48,41



GEBETANCHE

Chauffage



	DÉSIGNATION	UT	CODE	PPHT (€)
921.0042.52	RESINE GEBETANCHE CHAUFFAGE -FL.75ML- 114607	U	3245B.5	50,02



GEBETANCHE

Gaz - Résine anaérobie



	DÉSIGNATION	UT	CODE	PPHT (€)
921.0032.05	RESINE GEBETANCHE GAZ -FLAC.75ML- 114609	U	0800C.6	53,41

DROGUERIE

ETANCHEITE



GEBETANCHE

RT1 - Réseau eau potable



	DÉSIGNATION	UT	CODE	PPHT (€)
921.0049.75	RESINE ANAER.GEBETAN.EAU POT.RT1 75ML 114671	U	A0037.0	49,75



GEBETANCHE

RLC - Réseau eau potable



	DÉSIGNATION	UT	CODE	PPHT (€)
921.0029.09	RESINE ANAEROBIE RLC +FLACON 30ML 814655	U	395X7.1	29,09



PATCH D'ETANCHEITE

Colmatage des fuites sur des tuyaux rigides ou des descentes d'eau pluviales



	DÉSIGNATION	UT	CODE	PPHT (€)
921.0020.49	PATCH ETANCHEITE 10X15CM MAT.RIGIDES 127500	U	4201N.1	34,15



SPATEX

Pâte à joint spéciale pour hydrocarbures, joints plats et brides



	DÉSIGNATION	UT	CODE	PPHT (€)
921.0015.98	PATE A JOINT POLYV.SPATEX -TUBE 125ML- 103720	U	60674.9	18,80



ENLEV'JOINT

Pâte pour éliminer les restes de mastic silicone (durcis)



	DÉSIGNATION	UT	CODE	PPHT (€)
921.0010.18	ENLEVE JOINT POT 250L+PINCEAU 6150702	U	0285F.3	13,57

DROGUERIE

ETANCHEITE



EPOXY REPAIR STICK

Pâte époxy malléable à 2 composants pour la réparation et la restauration de la plupart des matériaux



	DÉSIGNATION	UT	CODE	PPHT (€)
921.0010.23	MASTIC EPOXY BATON 114G 6152402	U	1105A.0	15,04



GEOTEXTILE

Toile élastique - A combiner avec HBS-200 Caoutchouc Liquide



	DÉSIGNATION	UT	CODE	PPHT (€)
921.0013.48	BANDE ETANCH.GEOTEXTILE 20CMX15M 6308952	U	8695F.0	22,47



HBS-200 - CAOUTCHOUC LIQUIDE

Enduit écologique, universel pour protéger et rendre étanche à l'eau et à l'air



	DÉSIGNATION	UT	CODE	PPHT (€)
921.0030.67	CAOUTCHOUC LIQUIDE HBS-200 -POT 1L- 6308866	U	86940.4	51,11
921.0124.28	CAOUTCHOUC LIQUIDE HBS-200 -POT 5L- 6308867	U	8694J.4	207,13
921.0010.19	CAOUTCHOUC LIQUIDE HBS-200 -CART310G- 6312857	U	193WK.4	13,59



HBS-200 - CAOUTCHOUC LIQUIDE

Ruban adhésif élastique et universel pour protéger et rendre étanche à l'eau et à l'air. Idéal pour les réparations



	DÉSIGNATION	UT	CODE	PPHT (€)
921.0018.86	RUBAN ADHESIF HBS-200 TAPE 7.5CMX5M 6312056	U	9401R.2	18,86

DROGUERIE

ETANCHEITE



KOLMAT FIBRE SEAL

Bande d'étanchéité imprégnée et renforcée de fibres pour raccords filetés en métal et en matière synthétique. Avec ACS et utilisation gaz (EN 751-2)



	DÉSIGNATION	UT	CODE	PPHT (€)
921.0010.77	BANDE ETANCH.KOLMAT FIBRE SEAL 12X15 6300531	U	3082E.4	10,77



SFT-101 REPAIR

Ruban de réparation auto-fusionnant à base de silicone, qui isole et rend étanche les installations - Réparation universelle



	DÉSIGNATION	UT	CODE	PPHT (€)
921.0018.11	RUBAN SFT-101 REPAIR 25MMX3M 6311144	U	7233P.4	24,15



LISS'JOINT

Produit de lissage sans acides pour une finition rapide et simple - Produit de lissage universel sans acide



	DÉSIGNATION	UT	CODE	PPHT (€)
921.0013.72	PRODUIT LISSAGE LISS'JOINT-AER.400ML- 6301971	U	0748H.0	18,29



RUBSON

Mousse expansive - FIT EXPRESS



	DÉSIGNATION	UT	CODE	PPHT (€)
921.0026.92	MOUSSE EXP.FIX EXPRESS AER.750ML 1619486	U	8268N.2	53,84



RUBSON

Mousse expansive - Multi-Usage



	DÉSIGNATION	UT	CODE	PPHT (€)
000.0036.00	MOUSSE EXPANSIVE AEROSOL 21L RUBSON 2776430	U	A0273.1	48,00

DROGUERIE

ETANCHEITE



TANGIT
UNI-LOCK - Fil d'étanchéité



	DÉSIGNATION	UT	CODE	PPHT (€)
921.0029.00	FIL ETANCH.TANGIT UNI-LOCK BOBINE 80M 2055925	U	6908B.6	38,67

DROGUERIE



ACIDE CHLORHYDRIQUE
Acide Chlorhydrique



	DÉSIGNATION	UT	CODE	PPHT (€)
020.0004.96	ACIDE CHLORHYDRIQUE BIDON 1L	U	57547.2	6,20
020.0018.33	ACIDE CHLORHYDRIQUE BIDON 5L	U	53486.7	22,91



SOLVANT
Acétone



	DÉSIGNATION	UT	CODE	PPHT (€)
900.0039.06	ACETONE BIDON 5L	U	50056.1	39,06



SOLVANT
Alcool à brûler



	DÉSIGNATION	UT	CODE	PPHT (€)
000.0004.04	ALCOOL A BRULER 90 BIDON 1L	U	57539.9	4,04



WHITE SPIRIT
White spirit



	DÉSIGNATION	UT	CODE	PPHT (€)
020.0006.94	WHITE SPIRIT 1L	U	52912.3	8,68

DROGUERIE

DROGUERIE



SAVON
Crème



	DÉSIGNATION	UT	CODE	PPHT (€)
000.0015.99	SAVON COBIC CREME 5L COBS0558	U	5568G.8	15,99



SAVON
Gel



	DÉSIGNATION	UT	CODE	PPHT (€)
000.0009.28	SAVON COBIC BIORANGE 600ML COBS3510	U	5568D.5	9,28



SAVON
Gel avec pompe intégrée



	DÉSIGNATION	UT	CODE	PPHT (€)
000.0019.11	SAVON COBIC BIORANGE POMPE INTEG.3L COBS3509	U	0926H.4	19,11



RENOVATION
Enduit de rebouchage - Pâte - Enduit multi-usage
4 en 1



	DÉSIGNATION	UT	CODE	PPHT (€)
000.0013.52	ENDUIT 4 EN 1 MULTI-US.PATE -1.5KG- 30604209	U	225WC.0	19,32



NETTOYANT
MS9 - EasyCleaner - Nettoyant dégraissant



	DÉSIGNATION	UT	CODE	PPHT (€)
921.0019.47	NETTOYANT UNIVER.EASYCLEANER -500ML- 30613369	U	207LZ.9	19,47



GRAISSE
S6959 - Graisse spéciale gaz (Graissage et étanchéité
des robinets à gaz)



	DÉSIGNATION	UT	CODE	PPHT (€)
921.0012.89	GRAISSE S 6959 -ETUI-TUBE 20G- 515320	U	27608.9	15,17

DROGUERIE

DROGUERIE



GRAISSE
1695 - Multiservice



	DÉSIGNATION	UT	CODE	PPHT (€)
921.0015.52	GRAISSE MULTISERVICE -TUBE PEGB.125ML- 651145	U	0693F.9	20,69
921.0027.43	GRAISSE MULTISERVICE -BTE600G- 651147	U	210KR.0	36,57



GRAISSE
Silicone - Graisse contact eau potable pour lubrifier la robinetterie sanitaire - Boîte



	DÉSIGNATION	UT	CODE	PPHT (€)
921.0105.01	GRAISSE SILICONE -BOITE 330G- 651153	U	17546.3	105,01



GRAISSE
Silicone - Graisse contact eau potable pour lubrifier la robinetterie sanitaire - Tube



	DÉSIGNATION	UT	CODE	PPHT (€)
921.0014.54	GRAISSE SILICONE ETUI -TUBE 20G- 515520	U	19641.0	17,11
921.0026.24	GRAISSE SILICONE PEOARDAB.TUBE -125ML- 515521	U	78435.5	43,73



LIMPIMAIL
Produit de réparation des éclats d'émail sur sanitaires et appareils électroménagers



	DÉSIGNATION	UT	CODE	PPHT (€)
921.0008.96	LIMPIMAIL BLANC BLISTER TUBE 20ML 956831	U	45204.5	10,54



CLEANER +
Décapant



	DÉSIGNATION	UT	CODE	PPHT (€)
900.0024.76	PRIMAIRE CLEANER -BIDON 1L- CLEANER+	U	8447N.6	24,76

DROGUERIE

DROGUERIE



ANTI-MOISSISSURES
Pour enlever et supprimer les moisissures - Avec formule mousse et spray active



	DÉSIGNATION	UT	CODE	PPHT (€)
921.0021.40	ANTI-MOISSISSURES 750ML 6309645	U	4001Q.9	21,40



CLEAN'IN
Anti-calcaire - Spray moussant concentré pour éliminer le calcaire



	DÉSIGNATION	UT	CODE	PPHT (€)
921.0010.63	ANTICALCAIRE CLEAN'IN -PULV.500ML- 6313764	U	218F3.6	10,63



CLEAN'IN
Anti-graisse - Spray dégraissant concentré et puissant



	DÉSIGNATION	UT	CODE	PPHT (€)
921.0008.81	ANTIGRAISSE CLEAN'IN -PULV.500ML- 6313765	U	218F5.1	8,81



CLEAN'IN
Déboucheur - Liquide puissant en gel pur



	DÉSIGNATION	UT	CODE	PPHT (€)
921.0007.49	DEBOUCHEUR LIQU.PRO CLEAN'IN -BID.1L- 6313761	U	218ET.5	8,81



CLEAN'IN
Nettoyant - Nettoyant sanitaire pro



	DÉSIGNATION	UT	CODE	PPHT (€)
921.0008.81	NETTOYANT SANIT.CLEAN'IN -PULV.500ML- 6313763	U	218F1.0	8,81

DROGUERIE

DROGUERIE



DETAROX

Détartrant pour cuvettes de WC et urinoirs



	DÉSIGNATION	UT	CODE	PPHT (€)
000.0027.72	DETARTRANT SANITAIRE DETAROX 750ML ROX58	U	0159H.2	36,96



DEVOREX

Déboucheur choc des canalisations



	DÉSIGNATION	UT	CODE	PPHT (€)
030.0020.79	DEBOUCHEUR DEVOREX CANAL. FLACON 500ML	U	15762.8	27,72



SPIROCAN

Déboucheur choc des canalisations



	DÉSIGNATION	UT	CODE	PPHT (€)
030.0042.82	DEBOUCHEUR SPIROCAN CANALISATION FLACON 1L	U	17941.6	57,09

QUINCAILLERIE



ETIQUETTE

Barrage gaz



BARRAGE GAZ

	DÉSIGNATION	UT	CODE	PPHT (€)
030.0002.73	ETIQUETTE BARRAGE GAZ BARRGAZ	U	96010.4	3,64



PROTECTION MECANIQUE

En aluminium



	DÉSIGNATION	UT	CODE	PPHT (€)
440.0032.40	PROTECTEUR EN ALUMINIUM LG.2M75 35X35	U	57661.1	43,20
440.0050.02	PROTECTEUR EN ALUMINIUM LG.2M75 60X60	U	57662.9	66,69
440.0101.25	PROTECTEUR EN ALUMINIUM LG.2M75 90X90	U	8689C.5	135,00

DROGUERIE

QUINCAILLERIE



RUBAN ADHESIF ALU

Classé feu M1 - 50 x 50 mm



	DÉSIGNATION	UT	CODE	PPHT (€)
000.0009.82	RUBAN ADHESIF ALU 50 50MX50MM APCO 194ZAP	U	2980J.0	13,10



RUBAN ADHESIF PVC

33 m x 50 mm



	DÉSIGNATION	UT	CODE	PPHT (€)
000.0008.33	RUBAN ADHESIF PVC BLANC 33MX50MM APCO 640	U	249P5.2	8,33
000.0006.53	RUBAN ADHESIF PVC NOIR 33MX50MM APCO 640	U	2980L.6	8,71
000.0004.87	RUBAN ADHESIF PVC ORANGE 33MX50MM APCO 752A	U	5235Q.4	4,87



RUBAN ADHESIF PP

Emballage - 100 x 48 mm



	DÉSIGNATION	UT	CODE	PPHT (€)
025.0003.87	RUBAN ADHESIF HAVANE 100MX48MM APCO 840	U	299EU.2	5,16



RUBAN ADHESIF TOILE

Tissu enduit PE - 50 m x 50 mm -
Ép.0,165mm

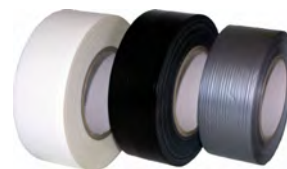

	DÉSIGNATION	UT	CODE	PPHT (€)
000.0009.10	TOILE ENDUIT PVC NOIR 50MX50MM APCO AP70	U	2760E.2	9,10



RUBAN ADHESIF TOILE

Tissu enduit PE - 50 m x 50 mm -
Ép.0,165mm - Par 24

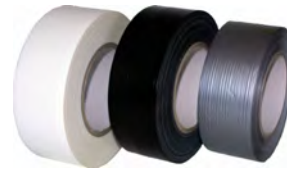

	DÉSIGNATION	UT	CODE	PPHT (€)
000.0009.10	TOILE ENDUIT PVC GRIS 50MX50MM -24- APCO AP70	U	5008U.0	9,10

DROGUERIE

QUINCAILLERIE



MARQUAGE AU SOL

Bande adhésive



DÉSIGNATION	UT	CODE	PPHT (€)
000.0010.80 RUBAN ADHESIF MARQUAGE SOL JNE/NOIR APCO 940	U	249PC.7	10,80



CHIFFON

A tout faire



DÉSIGNATION	UT	CODE	PPHT (€)
880.0006.55 CHIFFON A TOUT FAIRE SAC 800GRS	U	37358.9	7,71



CHIFFON

Molleton



DÉSIGNATION	UT	CODE	PPHT (€)
000.0016.56 CHIFFON MOLLETON COULEUR 010121S SAC DE 10K	U	82505.9	16,56



CHIFFON

Tricot blanc



DÉSIGNATION	UT	CODE	PPHT (€)
000.0036.51 CHIFFON TRICOT BLANC 010106S SAC DE 10K	U	82766.7	36,51



OUATES

Chamois



DÉSIGNATION	UT	CODE	PPHT (€)
907.0011.10 OUATE CHAMOIS -BOBINE- 22X35CM	U	37353.0	11,10



ADHESIF TOILE PRO

Pour étancher, isoler, réparer, protéger, immobiliser et joindre la plupart des matériaux - Adhésif toilé (duck tape)



DÉSIGNATION	UT	CODE	PPHT (€)
921.0012.46 ADHESIF TOILE GRIS-R.25M- 6310239	U	5880T.6	16,61

DROGUERIE

QUINCAILLERIE



ADHESIF TOILE PRO

Pour étancher, isoler, réparer, protéger, immobiliser et joindre la plupart des matériaux - Adhésif toilé (duck tape) - suite



DÉSIGNATION	UT	CODE	PPHT (€)
921.0012.46 ADHESIF TOILE ORANGE -R.25M- 6310240	U	5880W.9	16,61



WIPES SCRUB

Lingettes de nettoyage multi-usages professionnel avec scrub



DÉSIGNATION	UT	CODE	PPHT (€)
921.0022.46 LINGETTE NETTOYANTES UNIVERS. -75- 6307282	U	0158C.4	28,07

J+0 100% Dispo



SCANNEZ,
commandez,

Téléchargez sur

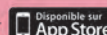

SUPPORTAGE ET FIXATION

SUPPORTAGE

I.N.G. FIXATIONS

COLLIER TWIST CLIP

Pour tige filetée M8



	DÉSIGNATION	UT	CODE	PPHT (€)	ECOPART (€)
907.0028.07	COLLIER TWIST CLIP D.32 -SAC.15-ING A181410	U	89378.4	56,14	0,01
907.0070.87	COLLIER TWIST CLIP D.40 -SAC.15-ING A181420	U	9048P.5	70,88	0,01

I.N.G. FIXATIONS

FEUILLARD

Non perforé - Zingué - Rouleau de 25 m

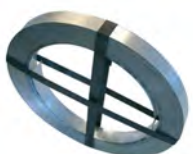

	DÉSIGNATION	UT	CODE	PPHT (€)	ECOPART (€)
907.0040.05	FEUILLARD NON PERFORE 25M 17X0,6 ING A190030	U	3907M.2	40,06	0,01

MÜPRO

COLLIER A VIS

Euro-Quick - EPDM isolation phonique - électrozingué



	DÉSIGNATION	UT	CODE	PPHT (€)
910.0001.68	COLLIER EURO-QUICK M8/10 78-84MM 132133	U	97323.0	1,68

MÜPRO

COLLIER A VIS

Euro-Quick Type EXP - Avec garniture - électrozingué



	DÉSIGNATION	UT	CODE	PPHT (€)
910.0000.50	COLLIER EURO-Q.EXP M8 3/8" 17-23 172004	U	270T6.2	0,67
910.0000.52	COLLIER EURO-Q.EXP M8 1/2" 21-26 172005	U	270TW.0	0,70
910.0000.55	COLLIER EURO-Q.EXP M8 3/4" 26-30 172006	U	270U0.4	0,73
910.0000.55	COLLIER EURO-Q.EXP M8 1" 33-37 172007	U	270U3.8	0,73
910.0000.70	COLLIER EURO-Q.EXP M8 1"1/4 40-44 172008	U	270U7.9	0,93
910.0000.76	COLLIER EURO-Q.EXP M8 1"1/2 48-52 172009	U	270UA.2	1,01
910.0000.86	COLLIER EURO-Q.EXP M8 54MM 53-58 172010	U	270UD.6	1,15
910.0000.94	COLLIER EURO-Q.EXP M8 2" 60-64 172011	U	270AF.5	1,26
910.0000.73	COLLIER EURO-Q.EXP M8/M10 2" 67-76 172012	U	270UF.1	1,41
910.0001.18	COLLIER EURO-Q.EXP M8/M10 2"1/2 75-81 172013	U	270UG.9	1,58
910.0001.37	COLLIER EURO-Q.EXP M8/M10 3" 87-95 172015	U	270UN.6	1,83
910.0001.52	COLLIER EURO-Q.EXP M8/M10 94-104MM 172016	U	270U0.2	2,03
910.0001.66	COLLIER EURO-Q.EXP M8/M10 4" 109-117 172018	U	270UU.3	2,22
910.0002.28	COLLIER EURO-Q.EXP M8/M10 4" 122-133 172019	U	270UV.1	3,04
910.0003.10	COLLIER EURO-Q.EXP M8/M10 5" 135-145 172021	U	270UX.7	4,14
910.0004.15	COLLIER EURO-Q.EXP M8/M10 6" 158-169 172023	U	270UZ.4	5,53
910.0004.59	COLLIER EURO-Q.EXP M8/M10 194-204 172024	U	270V0.3	6,12
910.0005.20	COLLIER EURO-Q.EXP M8/M10 8" 214-224 172025	U	270V1.1	6,94

SUPPORTAGE ET FIXATION

SUPPORTAGE

MÜPRO

COLLIER A VIS

LOURD - DÄMMGULAST jaune - Électrozingué



	DÉSIGNATION	UT	CODE	PPHT (€)
910.0027.62	COLLIER LOURD DAMMGULAST JAUN.M12 273 122234	U	1396K.8	36,82

MÜPRO

COLLIER A VIS

OPTIMAL - garniture isophonique DÄMMGULAST vert - Électrozingué



	DÉSIGNATION	UT	CODE	PPHT (€)
910.0001.56	COLLIER OPTIMAL DAMMGULAST M8 3/8 119838	U	39840.4	2,08
910.0001.60	COLLIER OPTIMAL DAMMGULAST M8 1/2 119818	U	39845.3	2,14
910.0001.79	COLLIER OPTIMAL DAMMGULAST M8 3/4 119834	U	39847.9	2,39
910.0001.90	COLLIER OPTIMAL DAMMGULAST M8 1" 119806	U	39849.5	2,53
910.0002.02	COLLIER OPTIMAL DAMMGULAST M8 1"1/4 119814	U	39855.2	2,70
910.0002.14	COLLIER OPTIMAL DAMMGULAST M8 1"1/2 119810	U	39856.0	2,85
910.0002.41	COLLIER OPTIMAL DAMMGULAST M8 2" 119826	U	39857.8	3,21
910.0003.40	COLLIER OPTIMAL DAMMGULAST M8-10 2"1 2 119874	U	55697.7	4,54
910.0003.72	COLLIER OPTIMAL DAMMGULAST M8-10 3" 119794	U	55698.5	4,96
910.0004.04	COLLIER OPTIMAL DAMMGULAST M8-10 102 119770	U	0672B.3	5,38
910.0005.10	COLLIER OPTIMAL DAMMGULAST M8-10 125MM 119782	U	97483.2	6,80
910.0006.24	COLLIER OPTIMAL DAMMGULAST M8-10 160MM 119790	U	41991.1	8,32
910.0002.06	COLLIER OPTIMAL DAMMGULAST M8 1/4 119822	U	2498K.3	2,06

MÜPRO

COLLIER A VIS

OPTIMAL coulissant - Électrozingué



	DÉSIGNATION	UT	CODE	PPHT (€)
910.0001.92	COLLIER OPTIMAL COULISSANT M8 25MM 119910	U	97445.1	2,56
910.0002.02	COLLIER OPTIMAL COULISSANT M8 32MM 119914	U	97446.9	2,70
910.0002.24	COLLIER OPTIMAL COULISSANT M8 40MM 119918	U	97447.7	2,99
910.0002.41	COLLIER OPTIMAL COULISSANT M8 50MM 119922	U	13248.0	3,21
910.0002.92	COLLIER OPTIMAL COULISSANT M8 63MM 119930	U	13251.4	3,89
910.0005.37	COLLIER OPTIMAL COULISSANT M8-10 110MM 119934	U	97450.1	7,16

MÜPRO

CONSOLE RAIL MPC

Électrozingué



	DÉSIGNATION	UT	CODE	PPHT (€)
020.0004.65	CONSOLE RAIL MPC 27/18 200MM EP.1.25MM 156710	U	5561X.3	7,16
020.0005.65	CONSOLE RAIL MPC 27/18 300MM EP.1.25MM 156711	U	5562R.5	8,69
910.0008.05	CONSOLE RAIL MPC 27/18 500MM EP.1.25MM 156712	U	8740L.4	12,38
020.0007.04	CONSOLE RAIL MPC 28/30 400MM EP.1.75MM 156714	U	5562S.3	10,83
020.0006.25	CONSOLE RAIL MPC 38/40 240MM EP.2MM 156716	U	6770G.0	9,62
020.0007.39	CONSOLE RAIL MPC 38/40 320MM EP.2MM 156717	U	6941U.8	11,37
020.0009.64	CONSOLE RAIL MPC 38/40 400MM EP.2MM 156718	U	5562V.6	12,86

Le PPHT comprend l'ecopart (€)

SUPPORTAGE ET FIXATION

SUPPORTAGE

MÜPRO

CONSOLE RAIL MPC

Électrozinguée
- suite



	DÉSIGNATION	UT	CODE	PPHT (€)
020.0009.46	CONSOLE RAIL MPC 38/40 480MM EP.2MM 156719	U	55638.1	14,56
020.0010.10	CONSOLE RAIL MPC 38/40 560MM EP.2MM 156720	U	5563M.2	15,54
020.0012.60	CONSOLE RAIL MPC 38/40 640MM EP.2MM 156721	U	6104M.6	19,38
020.0014.40	CONSOLE RAIL MPC 38/40 720MM EP.2MM 156727	U	6282W.1	22,15
020.0015.22	CONSOLE RAIL MPC 38/40 800MM EP.2MM 156728	U	6211F.9	23,41
910.0017.57	CONSOLE RAIL MPC 38/40 1040MM EP.2MM 156722	U	8284P.0	27,03

MÜPRO

AUTRES COLLIER

SPIRO avec DÄMMGULAST orange -
Electrozingué



	DÉSIGNATION	UT	CODE	PPHT (€)
910.0003.32	COLLIER SPIRO DAMMG.ORANGE M8/M10 125 143251	U	1558L.0	3,32
910.0002.92	COLLIER SPIRO DAMMG.ORANGE M8/M10 160 143254	U	1559H.6	3,89
910.0003.38	COLLIER SPIRO DAMMG.ORANGE M8/M10 200 143256	U	1560C.4	4,51
910.0004.38	COLLIER SPIRO DAMMG.ORANGE M8/M10 250 143258	U	15659.6	5,84
910.0005.37	COLLIER SPIRO DAMMG.ORANGE M8/M10 315 143261	U	1566A.2	7,16

MÜPRO

BANDE PERCEE

12 mm, ondulée, Rouleau de 10 m,
zinguée



	DÉSIGNATION	UT	CODE	PPHT (€)
020.0012.72	BANDE PERCEE ONDULEE SENDZ.L17MM -10M- 114801	U	78034.6	16,96

MÜPRO

CLIP DE FIXATION



	DÉSIGNATION	UT	CODE	PPHT (€)
909.0037.24	CLIP DE FIXATION KL100 CPS 50KG -B10- 172678	U	252FY.2	37,24

MÜPRO

RAIL

Rail d'installation, galvanisé sendzimir MPC



	DÉSIGNATION	UT	CODE	PPHT (€)
910.0008.10	RAIL INSTAL.MPC SENDZIMIR 27/18 -2M- 129911	U	24420.2	10,80
910.0011.45	RAIL INSTAL.MPC SENDZIMIR 28/30 -2M- 118590	U	24423.6	15,27
910.0015.76	RAIL INSTAL.MPC SENDZIMIR 38/40 -2M- 129917	U	24429.3	21,02
910.0026.06	RAIL INSTAL.MPC SENDZIMIR 38/40 -3M- 129945	U	52502.2	34,75
910.0091.38	RAIL INSTAL.MPC SENDZIMIR 38/40 -4M- 129964	U	52522.0	121,84

SUPPORTAGE ET FIXATION

SUPPORTAGE

MÜPRO

RAIL

Rail d'installation, galvanisé sendzimir MPC
- suite



	DÉSIGNATION	UT	CODE	PPHT (€)
910.0047.30	RAIL INSTAL.MPC SENDZIMIR 38/40 -6M- 130011	U	24430.1	63,07
910.0821.36	RAIL INSTAL.MPC SENDZIMIR 40/60 -6M- 130020	U	24442.6	1095,15

MÜPRO

ACCESSOIRES POUR RAIL

Boulon



	DÉSIGNATION	UT	CODE	PPHT (€)
909.0001.71	BOULON RAIL ZINGUE M8X30 38X40 40X60 115340	U	39759.6	2,28
909.0002.07	BOULON RAIL ZINGUE M10 38X40 40X60 115298	U	60039.5	2,76

MÜPRO

ACCESSOIRES POUR RAIL

Capuchon pour rails d'installation et console-
rail - MPC



	DÉSIGNATION	UT	CODE	PPHT (€)
909.0000.38	CAPUCHON SECURIT RAIL INSTAL.27/18 106000	U	28957.9	0,50
909.0000.44	CAPUCHON SECURIT RAIL INSTAL.28/30 106002	U	39787.7	0,59
909.0000.55	CAPUCHON SECURIT RAIL INSTAL.38/40 106006	U	39750.5	0,73

MÜPRO

ACCESSOIRES POUR RAIL

Crampon serre-joint, électrozingué - Trou lisse



	DÉSIGNATION	UT	CODE	PPHT (€)
909.0002.58	CRAMPON SERRE-JOINT LISSE M8 130248	U	40037.4	3,44
909.0002.85	CRAMPON SERRE-JOINT LISSE M10 130251	U	35583.4	3,80

MÜPRO

ACCESSOIRES POUR RAIL

Double écrou MPC - Electrozingué



	DÉSIGNATION	UT	CODE	PPHT (€)
909.0000.65	DOUBLE ECROU MPC M8X30MM ZINGUE 27/18 115152	U	97961.7	0,87
909.0000.82	DOUBLE ECROU MPC M8X35MM ZINGUE 38/40 115074	U	53275.4	1,10
909.0001.16	DOUBLE ECROU MPC M10X35MM ZINGUE 27/18 115104	U	1397C.3	1,55
909.0001.40	DOUBLE ECROU MPC M12X35MM ZINGUE 38/40 115014	U	30653.0	1,86

SUPPORTAGE ET FIXATION

SUPPORTAGE

MÜPRO

ACCESSOIRES POUR RAIL

Eclisse rail MPC - Électrozinguée



	DÉSIGNATION	UT	CODE	PPHT (€)
909.0011.14	ECLISSE-RAIL M8 PROFIL 27/18-28/30 120060	U	08483.0	11,14
910.0013.91	ECLISSE-RAIL M10 PROFIL 41/21-41/62 163109	U	5588F.6	13,91

MÜPRO

ACCESSOIRES POUR RAIL

Ecrou rail MPC



	DÉSIGNATION	UT	CODE	PPHT (€)
909.0000.76	ECROU RAIL ZINGUE M8 38/24-40/120 118040	U	42511.6	0,76

MÜPRO

ACCESSOIRES POUR RAIL

Equerre 90°, électrozinguée - courte



	DÉSIGNATION	UT	CODE	PPHT (€)
909.0003.32	EQUERRE 90 COURTE 2 TROU P.RAIL 38/40 118820	U	45762.2	4,42

MÜPRO

ACCESSOIRES POUR RAIL

Equerre de consolidation, électrozinguée



	DÉSIGNATION	UT	CODE	PPHT (€)
909.0014.49	EQUERRE CONSOLID.COTES EGAUX 4 ZINGUEE 113628	U	59963.9	19,32

MÜPRO

ACCESSOIRES POUR RAIL

Equerre MPC 90°, électrozinguée - Standard



	DÉSIGNATION	UT	CODE	PPHT (€)
909.0005.16	CONSOLE 90 P.RAIL 38/40 5 TROU 118808	U	58599.2	6,88

MÜPRO

ACCESSOIRES POUR RAIL

Equerre MPC 90°, électrozinguée - Prémontée



	DÉSIGNATION	UT	CODE	PPHT (€)
910.0014.95	CONSOLE PREM.90 5 TROUS P.RAIL 38/24 147764	U	8423W.7	14,95

SUPPORTAGE ET FIXATION

SUPPORTAGE

MÜPRO

ACCESSOIRES POUR RAIL

Equerre MPC pour profils 27/18 et 28/30, électrozinguée - 45°



	DÉSIGNATION	UT	CODE	PPHT (€)
909.0003.53	CONSOLE 45 P.RAIL 27/18 - 28/30 118753	U	78568.3	4,71

MÜPRO

ACCESSOIRES POUR RAIL

Equerre MPC pour profils 27/18 et 28/30, électrozinguée - 90°



	DÉSIGNATION	UT	CODE	PPHT (€)
909.0003.34	EQUERRE MPC 90D RAIL 27/18-28/30 ZIN 118797	U	59982.9	4,45

MÜPRO

ACCESSOIRES POUR RAIL

Equerre MPC pour profils 38/24 jusqu'à 40/120, électrozinguée - 45°



	DÉSIGNATION	UT	CODE	PPHT (€)
909.0007.72	CONSOLE 45 P.RAIL 38/40 118769	U	58596.8	10,29

MÜPRO

ACCESSOIRES POUR RAIL

Feragrip MPC - Crapautage sécurisé - Electrozingué



	DÉSIGNATION	UT	CODE	PPHT (€)
909.0003.64	FIXATION FERAGRIP MPC M8 24/38 38/40 130283	U	40061.4	4,85
909.0005.39	FIXATION FERAGRIP MPC M10 38/40 40/60 130273	U	97018.6	7,19

MÜPRO

ACCESSOIRES POUR RAIL

Fixation rapide MPC taraudée, électrozinguée - Pour le montage d'angle



	DÉSIGNATION	UT	CODE	PPHT (€)
909.0001.70	FIXATION MPC P.MONTAGE EQ.M10 120782	U	07046.6	2,43

MÜPRO

ACCESSOIRES POUR RAIL

Jambe de force, électrozinguée



	DÉSIGNATION	UT	CODE	PPHT (€)
909.0036.62	JAMBE DE FORCE P.CONSOLE RAIL LG.440MM 129790	U	2685A.6	48,82
909.0077.70	JAMBE DE FORCE P.CONSOLE RAIL LG.900MM 139228	U	5678J.0	77,70

SUPPORTAGE ET FIXATION

SUPPORTAGE

MÜPRO

ACCESSOIRES POUR RAIL

Plaque de verrouillage MPC - Electrozingué



	DÉSIGNATION	UT	CODE	PPHT (€)
020.0000.99	PLAQUE VERROUILLAGE GALV.RAIL M8 38/40 114447	U	83440.8	1,32
020.0000.99	PLAQUE VERROUILLAGE GAL.RAIL M10 38/40 114450	U	12940.3	1,32

MÜPRO

ACCESSOIRES POUR RAIL

Platine U MPC, électrozinguée - Soudure transversale



	DÉSIGNATION	UT	CODE	PPHT (€)
020.0014.78	PLATINE U ZING.SOUDEURE TRANSV.T2 38/40 156816	U	6059R.3	14,78

MÜPRO

ACCESSOIRES POUR RAIL

Platine U MPC, électrozinguée - Soudure longitudinale



	DÉSIGNATION	UT	CODE	PPHT (€)
020.0011.28	PLATINE U ZING.SOUD.LONG.27/18-28/30 156811	U	6546T.0	11,28
020.0012.40	PLATINE U ZINGUEE SOUDEURE LONG.38/40 156809	U	5563R.4	16,53

MÜPRO

ACCESSOIRES POUR RAIL

Platine U MPC, électrozinguée - Articulée



	DÉSIGNATION	UT	CODE	PPHT (€)
909.0029.22	PLATINE U ARTICULEE ZINGUEE 129660	U	27110.6	38,96

MÜPRO

ACCESSOIRES POUR RAIL

Platine U MPC, électrozinguée - Prémontée



	DÉSIGNATION	UT	CODE	PPHT (€)
910.0020.03	PLATINE U PREMONTÉE SOUD.TRANSV.ZINGU. 156817	U	8807X.1	20,03

MÜPRO

ACCESSOIRES POUR RAIL

Oméga MPC, électrozingué



	DÉSIGNATION	UT	CODE	PPHT (€)
909.0003.46	FIXATION OMEGA GALVANISE PROFIL 38/40 118246	U	84456.3	4,62

SUPPORTAGE ET FIXATION

SUPPORTAGE

MÜPRO

ACCESSOIRES POUR RAIL

Té d'assemblage, électrozingué - Soudure transversale



	DÉSIGNATION	UT	CODE	PPHT (€)
020.0010.61	TE ASSEMBLAGE TRANSV.38/24-38/40-39/52 156799	U	6546P.8	13,26

MÜPRO

POINT FIXE ET SUPPORT

Kit support universel MPC, électrozingué - Avec isolation phonique



	DÉSIGNATION	UT	CODE	PPHT (€)
909.0084.52	SUPPORT UNIVERSEL INSONORISE TII 480MM 113493	U	24444.2	84,52
909.0086.54	SUPPORT UNIVERSEL INSONORISE TII 560MM 113511	U	52561.8	86,54
909.0093.86	SUPPORT UNIVERSEL INSONORISE TII 640MM 113517	U	24445.9	93,86

MÜPRO

FIXATION DE RAIL DE SUPPORTAGE

Segment basculant, électrozingué



	DÉSIGNATION	UT	CODE	PPHT (€)
909.0001.56	SEGMENT BASCULANT GALVA M6/100 113112	U	80304.9	2,08
909.0001.86	SEGMENT BASCULANT GALVA M8/100 113115	U	84908.3	2,48

MÜPRO

FIXATION DE RAIL DE SUPPORTAGE

Tête de segment basculant - M8



	DÉSIGNATION	UT	CODE	PPHT (€)
909.0001.15	TETE DE SEGMENT BASCULANT M8 100 162617	U	70081.5	1,15

MÜPRO

SOCLE

Plot Phonolyt, zingué - Fixation - atténuation acoustique 30dB



	DÉSIGNATION	UT	CODE	PPHT (€)
909.0058.95	PLOT PHONOLYT M10 120442	U	68037.1	58,95

MÜPRO

ACCESSOIRE DE MONTAGE

Ecrou hexagonal, DIN 934, électrozingué



	DÉSIGNATION	UT	CODE	PPHT (€)
909.0000.04	ECROU HEXAGONAL ZINGUE M8 -UNITE- 105498	U	42483.8	0,05
909.0000.14	ECROU HEXAGONAL ZINGUE M10 -UNITE- 105433	U	42487.9	0,14

SUPPORTAGE ET FIXATION

SUPPORTAGE

MÜPRO

ACCESSOIRE DE MONTAGE

Ecrou hexagonal, DIN 934, électrozingué
- suite



	DÉSIGNATION	UT	CODE	PPHT (€)
909.0000.19	ECROU HEXAGONAL ZINGUE M12 -UNITE- 105447	U	42500.9	0,25

MÜPRO

ACCESSOIRE DE MONTAGE

Goujon, électrozingué - Boiserie ou cheville
plastique



	DÉSIGNATION	UT	CODE	PPHT (€)
020.0000.36	GOUJON POUR BOISERIE M8/60 129717	U	71102.8	0,36
020.0000.64	GOUJON POUR BOISERIE M10/80 129680	U	70521.0	0,64

MÜPRO

ACCESSOIRE DE MONTAGE

Rosace plastique blanche



	DÉSIGNATION	UT	CODE	PPHT (€)
020.0000.63	ROSACE PLASTIQUE BLANCHE 14MM -1- 115351	U	74600.8	0,84
020.0000.63	ROSACE PLASTIQUE BLANCHE 16MM -1- 115359	U	74603.2	0,84
020.0000.63	ROSACE PLASTIQUE BLANCHE 18MM 115362	U	84315.1	0,84
020.0000.70	ROSACE PLASTIQUE BLANCHE 22MM 115372	U	74535.6	0,93
020.0000.95	ROSACE PLASTIQUE BLANCHE 3/4 115383	U	48550.7	0,95
020.0000.78	ROSACE PLASTIQUE BLANCHE 1" 115332	U	6596C.1	1,04
020.0001.30	ROSACE PLASTIQUE BLANCHE 1"1/4 115339	U	9825T.6	1,74
020.0000.66	ROSACE PLASTIQUE 1/2 115345	U	5436W.8	0,88

MÜPRO

ACCESSOIRE DE MONTAGE

Rondelle DÄMMGULAST - 1



	DÉSIGNATION	UT	CODE	PPHT (€)
909.0000.35	RONDELLE DAMMGULAST 28X8,5MM 107089	U	74576.0	0,47
909.0000.55	RONDELLE DAMMGULAST 34X10,5MM 107086	U	97007.9	0,73
909.0000.11	RONDELLE METAL 28X8,5MM -BTE100- 127229	U	74584.4	0,15

MÜPRO

ACCESSOIRE DE MONTAGE

Manchon de raccordement pour le
prolongement de tiges filetées -
Electrozingué rond



	DÉSIGNATION	UT	CODE	PPHT (€)
909.0000.81	MANCHON RACCORDEMENT GALVA M8/30 113259	U	39860.2	0,81
909.0001.12	MANCHON RACCORDEMENT GALVA M10/30 113175	U	84905.9	1,12

SUPPORTAGE ET FIXATION

SUPPORTAGE

MÜPRO

ACCESSOIRE DE MONTAGE

Manchon parallèle pour tiges filetées, électrozingué



	DÉSIGNATION	UT	CODE	PPHT (€)
020.0001.07	MANCHON PARALLELE GALVA M8 120137	U	40038.2	1,43

MÜPRO

ACCESSOIRE DE MONTAGE

Rondelle fixation de rails MPC -
Electrozinguée

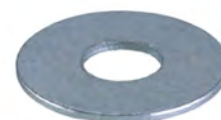

	DÉSIGNATION	UT	CODE	PPHT (€)
020.0000.25	RONDELLE ZINGUEE LARGE M6/36 127184	U	74532.3	0,33
020.0000.25	RONDELLE ZINGUEE LARGE M8/36 127214	U	37927.1	0,33
020.0000.25	RONDELLE ZINGUEE LARGE M10/36 127121	U	37934.7	0,33
020.0000.25	RONDELLE ZINGUEE LARGE M12/36 127151	U	37940.4	0,33

MÜPRO

ACCESSOIRE DE MONTAGE

Tirefond tête hexagonale, DIN 571 -
Electrozingué



	DÉSIGNATION	UT	CODE	PPHT (€)
020.0000.45	TIREFOND TETE HEXAGNALE ZINGUE 8X60MM 105400	U	9066U.1	0,45

MÜPRO

ACCESSOIRE DE MONTAGE

Tige filetée électrozinguée



	DÉSIGNATION	UT	CODE	PPHT (€)
909.0000.76	TIGE FILETEE ZINGUEE LONG.M8 -1M- 113639	U	42553.8	1,01
909.0001.16	TIGE FILETEE ZINGUEE LONG.M10 -1M- 113467	U	42566.0	1,55
909.0001.76	TIGE FILETEE ZINGUEE LONG.M12 -1M- 113513	U	42599.1	2,34

MÜPRO

INSONORISATION

Amortisseur DÄMMGULAST - Atténuation
acoustique moyenne de 17 dB(A) électrozingué
- Pour filetage M8/M10



	DÉSIGNATION	UT	CODE	PPHT (€)
909.0002.24	AMORTISSEUR DAMMGULAST 43/10,5MM 107083	U	72409.6	2,99

SUPPORTAGE ET FIXATION

SUPPORTAGE

MÜPRO

STABOFIX

Profil StaboFix, électrozingué - Système de fixation flexible



	DÉSIGNATION	UT	CODE	PPHT (€)
909.0013.50	PROFIL STABOFIX ZINGUE 2000X50X3 129076	U	27114.8	18,00

MÜPRO

SUSPENSION

Béton - Câble S



	DÉSIGNATION	UT	CODE	PPHT (€)
909.0072.81	SUSPENSION BETON +CHEV.S 50KG 2M -S10- 172642	U	26469.6	72,81
909.0058.41	SUSPENSION BETON +CHEV.S 50KG 3M -S10- 172656	U	313DB.9	77,88

MÜPRO

SUSPENSION

Embout boucle - Câble S



	DÉSIGNATION	UT	CODE	PPHT (€)
000.0032.68	SUSPENSION STD BOUCLE S 50KG 1M -S.10- 172623	U	313CS.8	32,68
909.0036.55	SUSPENSION STD BOUCLE S 50KG 2M -S.10- 172644	U	26467.0	66,46
909.0039.34	SUSPENSION STD BOUCLE S 50KG 3M -S.10- 172658	U	26468.8	71,53

MÜPRO

SUSPENSION

Kit cassette



	DÉSIGNATION	UT	CODE	PPHT (€)
909.0049.53	KIT CASSETTE EMBOUT BOUCLE CPS 45KG 3M 173841	U	2646D.7	49,53
909.0047.48	KIT CASSETTE EMBOUT BOUCLE CPS 45KG 2M 173840	U	265XM.5	47,48

MÜPRO

SUPPORT

Big foot - Gaine en H - H305



	DÉSIGNATION	UT	CODE	PPHT (€)
909.0042.62	SUPPORT BIG FOOT H305 170145	U	202VL.2	56,83

SUPPORTAGE ET FIXATION

FIXATION



BOULON

6 pans - A écrou - Zingué



	DÉSIGNATION	UT	CODE	PPHT (€)
000.0001.42	BOULON +ECROU 6 PANS ZINGUE -BTE25- 16X60	U	59087.7	2,18
000.0002.16	BOULON 6 PANS ZINGUE A ECROU 16X70	U	59089.3	3,33



ACCESSOIRES VISSERIE

Tige filetée - Zinguée



	DÉSIGNATION	UT	CODE	PPHT (€)
907.0000.97	TIGE FILETEE ZINGUEE 6 PAS DE 100	U	15919.4	1,39
907.0001.44	TIGE FILETEE ZINGUEE 7 PAS DE 150	U	52193.0	2,06
907.0001.53	TIGE FILETEE ZINGUEE 8 PAS DE 125	U	15921.0	2,18
907.0002.44	TIGE FILETEE ZINGUEE 10 PAS DE 150	U	15929.3	3,49
907.0003.90	TIGE FILETEE ZINGUEE 12 PAS DE 175	U	15930.1	5,57
907.0007.06	TIGE FILETEE ZINGUEE 16 PAS DE 200	U	50443.1	10,09

fischer

CHEVILLE METAL

Pince pour cheville PA



	DÉSIGNATION	UT	CODE	PPHT (€)	ECOPART (€)
000.0093.41	PINCE POUR CHEVILLE PA 26846	U	33573.7	93,42	0,01

fischer

FIXATION

Pour lavabo et urinoir



	DÉSIGNATION	UT	CODE	PPHT (€)	ECOPART (€)
907.0011.91	FIXATION LAVABO WST 12X150-JEU- FISCHER 80661	U	3169J.1	17,02	0,01

fischer

FIXATION

Pour WC et bidets au sol - Jeu de fixations



	DÉSIGNATION	UT	CODE	PPHT (€)	ECOPART (€)
907.0004.30	FIXATION BIDET/WC S8RD80WCR-JEU-FISCHER 60568	U	23831.1	6,15	0,01

Le PPHT comprend l'ecopart (€)

Les tarifs et disponibilités de nos produits peuvent évoluer sans préavis

RICHARDSON

| 349 |

SUPPORTAGE ET FIXATION

FIXATION

fischer
FIXATION

Pour WC - Pour fixation latérale de cuvettes de WC



	DÉSIGNATION	UT	CODE	PPHT (€)	ECOPART (€)
907.0019.95	FIXATION WC EQ.WB5N -JEU- FISCHER 18652	U	92559.4	28,51	0,01



COLLIER

Instantané pour raccord PVC évacuation - Avec insert taraudé 7 x 150



	DÉSIGNATION	UT	CODE	PPHT (€)
256.0000.58	COLLIER INSTANT.PVC EV 32 GIRPI CI32	U	02561.9	0,97
256.0000.65	COLLIER INSTANT.PVC EV 40 GIRPI CI40	U	02562.7	1,08
256.0000.79	COLLIER INSTANT.PVC EV 50 GIRPI CI50	U	02563.5	1,32



COLLIER

A charnière pour raccord PVC évacuation - Avec insert 7 x 150



	DÉSIGNATION	UT	CODE	PPHT (€)
000.0001.68	COLLIER CHARNIERE PVC EV 63 GIRPI CAB63	U	02564.3	2,80
000.0001.86	COLLIER CHARNIERE PVC EV 80 GIRPI CAC80	U	02566.8	3,10
000.0002.40	COLLIER CHARNIERE PVC EV 100 GIRPI CAC100	U	02568.4	4,00
000.0003.00	COLLIER CHARNIERE PVC EV 125 GIRPI CAB125	U	02570.0	5,00

I.N.G. FIXATIONS

ACCESSOIRES VISSERIE

Embase - Pour collier



	DÉSIGNATION	UT	CODE	PPHT (€)	ECOPART (€)
907.0026.21	EMBASE COLLIER -BTE100-ING A280145	U	1087Y.5	26,22	0,01

I.N.G. FIXATIONS

ACCESSOIRES VISSERIE

Entretoise FF



	DÉSIGNATION	UT	CODE	PPHT (€)	ECOPART (€)
907.0026.04	ENTRETOISE FF 7X30 -BTE100-ING A503325	U	72025.0	37,21	0,01
907.0028.76	ENTRETOISE FF 8X30 -BTE100-ING A503340	U	72039.1	41,10	0,01
907.0037.44	ENTRETOISE FF 10X30 -BTE100-ING A503350	U	2132K.5	53,50	0,01

SUPPORTAGE ET FIXATION

FIXATION

I.N.G. FIXATIONS

ACCESSOIRES VISSERIE

Rallonge MF - En sachet



	DÉSIGNATION	UT	CODE	PPHT (€)	ECOPART (€)
907.0004.96	RALLONGE MF 7X150 LG.40 -SAC10- ING A509914	U	31636.4	7,09	0,01

I.N.G. FIXATIONS

ACCESSOIRES VISSERIE

Rallonge MF - M7 x 150 Finition zinguée blanche



	DÉSIGNATION	UT	CODE	PPHT (€)	ECOPART (€)
907.0022.61	RALLONGE MF 7X150 LG.10 -BT100- ING A512710	U	3045D.3	22,62	0,01
907.0018.06	RALLONGE MF 7X150 LG.20 -BT100- ING A512714	U	3053K.8	25,81	0,01
907.0021.66	RALLONGE MF 7X150 LG.30 -BT100- ING A512718	U	30545.8	30,95	0,01
907.0024.47	RALLONGE MF 7X150 LG.40 -BT100- ING A512722	U	3054K.7	34,97	0,01

I.N.G. FIXATIONS

ACCESSOIRES VISSERIE

Rallonge MF - M8 x 125 Finition zinguée blanche



	DÉSIGNATION	UT	CODE	PPHT (€)	ECOPART (€)
907.0017.91	RALLONGE MF 8X125 30 Z6.BLC -50- ING A512730	U	212V0.5	25,60	0,01
907.0022.53	RALLONGE MF 8X125 40 Z6.BLC -50- ING A512732	U	212UN.8	32,20	0,01

I.N.G. FIXATIONS

ACCESSOIRES VISSERIE

Rallonge MF Hex. - M7 / M8 - Finition zinguée blanche



	DÉSIGNATION	UT	CODE	PPHT (€)	ECOPART (€)
907.0034.62	RALLONGE HEX.MF M7/M8 L.20-BTE100-ING A512740	U	215VE.7	49,47	0,01

I.N.G. FIXATIONS

PATTE A VIS

Outil de pose pour patte à vis



	DÉSIGNATION	UT	CODE	PPHT (€)
907.0036.36	OUTIL DE POSE P.A.V M7 IZY7 -1-ING A150003	U	3203K.7	48,48
907.0038.98	OUTIL DE POSE P.A.V M8 IZY8 -1-ING A150045	U	9361X.7	51,97

Le PPHT comprend l'ecopart (€)

SUPPORTAGE ET FIXATION

FIXATION

I.N.G. FIXATIONS

PATTE A VIS

Patte à vis bois - Zinguée jaune - M7 x 150 - Gamme sachet



	DÉSIGNATION	UT	CODE	PPHT (€)	ECOPART (€)
907.0002.95	PATTE A VIS BOIS 30 7X150 -S20- ING A509921	U	6318Q.2	4,21	
907.0003.13	PATTE A VIS BOIS 40 7X150 -S20- ING A509923	U	6078M.8	4,48	0,01
907.0003.30	PATTE A VIS BOIS 50 7X150 -S20- ING A509926	U	66788.1	4,73	0,01
907.0003.66	PATTE A VIS BOIS 60 7X150 -S20- ING A509928	U	3003F.8	5,24	0,01

I.N.G. FIXATIONS

PATTE A VIS

Patte à vis bois - Zinguée jaune - M8 x 125 - Gamme sachet



	DÉSIGNATION	UT	CODE	PPHT (€)	ECOPART (€)
907.0003.54	PATTE A VIS BOIS 60 8X125 -S10- ING A509933	U	30350.3	5,07	0,01
907.0003.01	PATTE A VIS BOIS 40 8X125 -S10- ING A509931	U	3909H.9	4,30	

I.N.G. FIXATIONS

PATTE A VIS

Patte à vis bois - Zinguée jaune - Sans collerette



	DÉSIGNATION	UT	CODE	PPHT (€)	ECOPART (€)
907.0026.24	PATTE VIS BOIS S.COLL M8X50 -B100-ING A180642	U	1660Q.6	34,99	0,01
907.0034.76	PATTE VIS BOIS S.COLL M8X60 -B100-ING A180644	U	1660S.2	46,36	0,01
907.0043.19	PATTE VIS BOIS S.COLL M8X80 -B100-ING A180646	U	1660T.0	57,60	0,01

I.N.G. FIXATIONS

PATTE A VIS

Patte à vis bois - Zinguée blanche - M7 x 125 - Gamme boîte



	DÉSIGNATION	UT	CODE	PPHT (€)	ECOPART (€)
907.0006.85	PATTE A VIS BOIS 30 7X150 -BTE100-ING A512810	U	166SW.1	9,79	0,01
907.0006.60	PATTE A VIS BOIS 40 7X150 -BTE100-ING A512812	U	166SX.9	9,44	0,01
907.0007.53	PATTE A VIS BOIS 50 7X150 -BTE100-ING A512814	U	166SY.7	10,76	0,01
907.0009.03	PATTE A VIS BOIS 60 7X150 -BTE100-ING A512816	U	166SZ.6	12,91	0,01

I.N.G. FIXATIONS

PATTE A VIS

Patte à vis bois - Zinguée blanche - M8 x 125 - Gamme boîte



	DÉSIGNATION	UT	CODE	PPHT (€)	ECOPART (€)
907.0012.19	PATTE A VIS BOIS 50 8X125 -BT100-ING A512854	U	30347.9	17,42	0,01
907.0014.85	PATTE A VIS BOIS 60 8X125 -BT100-ING A512856	U	3036A.0	21,23	0,01

Le PPHT comprend l'ecopart (€)

SUPPORTAGE ET FIXATION

FIXATION

I.N.G. FIXATIONS

PATTE A VIS

Patte à vis métal, zinguée



	DÉSIGNATION	UT	CODE	PPHT (€)	ECOPART (€)
907.0008.20	PATTE A VIS METAL 5X40 -BTE100-ING A506650	U	63864.3	13,67	0,01
907.0014.49	PATTE A VIS METAL 5X70 -BTE100-ING A506665	U	72384.1	19,33	0,01
907.0011.22	PATTE A VIS METAL 6X40 -BTE100-ING A506680	U	63884.1	16,04	0,01
907.0011.18	PATTE A VIS METAL 6X50 -BTE100-ING A506685	U	63896.5	18,65	0,01
907.0014.59	PATTE A VIS METAL 6X60 -BTE100-ING A506690	U	72404.7	20,85	0,01

I.N.G. FIXATIONS

CHEVILLE METAL

Alphagrip - Cheville métallique avec rondelle excentrée nylon



	DÉSIGNATION	UT	CODE	PPHT (€)	ECOPART (€)
907.0005.06	CHEVILLE METAL.ALPHAGRIP 8X37-S.2-ING A500635	U	71941.9	6,32	
907.0005.46	CHEVILLE METAL.ALPHAGRIP 8X55-S.2-ING A500640	U	59654.4	6,84	0,01
907.0006.21	CHEVILLE METAL.ALPHAGRIP 8X65-S.2-ING A500645	U	02175.8	7,77	0,01

I.N.G. FIXATIONS

CHEVILLE METAL

Brik - Cheville métallique pour parois creuse, zinguée - Avec vis



	DÉSIGNATION	UT	CODE	PPHT (€)	ECOPART (€)
907.0024.33	CHEVILLE BRIK AV.VIS 4X35 -BTE100-ING A506113	U	72317.1	34,77	0,01
907.0031.77	CHEVILLE BRIK AV.VIS 5X37 -BTE100-ING A506120	U	0177W.2	45,40	0,01
907.0037.03	CHEVILLE BRIK AV.VIS 5X52 -BTE100-ING A506123	U	0177X.0	52,91	0,01
907.0059.73	CHEVILLE BRIK AV.VIS 5X65 -BTE100-ING A506125	U	7854L.8	59,74	0,01
907.0038.56	CHEVILLE BRIK AV.VIS 6X37 -BTE100-ING A506130	U	0178M.0	55,10	0,01
907.0027.52	CHEVILLE BRIK AV.VIS 6X65 -BTE50- ING A506135	U	16976.6	36,71	0,01
907.0040.56	CHEVILLE BRIK AV.VIS 8X55 -BTE50- ING A506153	U	170KE.9	54,09	0,01
907.0050.62	CHEVILLE BRIK AV.VIS 8X65 -BTE50- ING A506155	U	1826P.9	67,51	0,01

I.N.G. FIXATIONS

CHEVILLE METAL

Brik - Cheville métallique pour parois creuse, zinguée - Sans vis



	DÉSIGNATION	UT	CODE	PPHT (€)	ECOPART (€)
907.0025.51	CHEVILLE BRIK SS.VIS 5X37 -BTE100-ING A506020	U	64863.4	36,46	0,01
907.0028.76	CHEVILLE BRIK SS.VIS 6X37 -BTE100-ING A506030	U	64906.1	41,10	0,01
907.0040.75	CHEVILLE BRIK SS.VIS 6X52 -BTE100-ING A506033	U	64917.8	58,22	0,01
907.0017.62	CHEVILLE BRIK SS.VIS 6X65 -BTE50-ING A506035	U	72222.3	29,37	0,01
907.0038.02	CHEVILLE BRIK SS.VIS 5X65 -BTE100-ING A506025	U	72203.3	50,71	0,01

SUPPORTAGE ET FIXATION

FIXATION

I.N.G. FIXATIONS

CHEVILLE METAL

Brik - Cheville métallique pour parois creuse, zinguée - Avec patte à vis M7



	DÉSIGNATION	UT	CODE	PPHT (€)	ECOPART (€)
907.0056.82	CHEVILLE BRIK +P.A.V.5X52 -BTE100-ING A506255	U	8654J.2	75,77	0,01
907.0053.60	CHEVILLE BRIK +P.A.V.6X37 -BTE100-ING A506270	U	177TV.9	71,47	0,01

I.N.G. FIXATIONS

CHEVILLE PLASTIQUE

Fixation chauffe-eau sur plaque de plâtre + polystyrène - Spécial parpaing ou brique - Avec rondelle soudée



	DÉSIGNATION	UT	CODE	PPHT (€)	ECOPART (€)
907.0020.52	CHEVILLE CHAUFFE EAU 14X130-SAC.4-ING A150030	U	26623.9	25,66	0,01

I.N.G. FIXATIONS

CHEVILLE PLASTIQUE

Kit Plak-Plâtre - Fixation chauffe-eau sur mur creux avec plaque de plâtre + polystyrène



	DÉSIGNATION	UT	CODE	PPHT (€)	ECOPART (€)
907.0050.75	CHEVILLE PLAK-PLATRE 16X240 ING A150080	U	26647.8	63,45	0,01

I.N.G. FIXATIONS

CHEVILLE PLASTIQUE

Polystyrène - Vissage direct dans l'isolant



	DÉSIGNATION	UT	CODE	PPHT (€)	ECOPART (€)
907.0101.36	CHEVILLE POLYSTYRENE 32X97 -BTE25-ING A136025	U	2295W.5	101,37	0,01

I.N.G. FIXATIONS

CHEVILLE PLASTIQUE

Pour collier électricien



	DÉSIGNATION	UT	CODE	PPHT (€)	ECOPART (€)
907.0020.36	CHEVILLE COLLIER ELEC.NOIR -S.100-ING A280140	U	1088M.7	20,37	0,01

I.N.G. FIXATIONS

COLLIER

Double - Pas de 7 x 150 - Finition zinguée blanche



	DÉSIGNATION	UT	CODE	PPHT (€)	ECOPART (€)
907.0014.53	COLLIER DOUBLE D.12 7X150 -BTE50-ING A512216	U	2931T.2	20,76	0,01
907.0013.94	COLLIER DOUBLE D.14 7X150 -BTE50-ING A512218	U	2936F.2	19,92	0,01

SUPPORTAGE ET FIXATION

FIXATION

I.N.G. FIXATIONS

COLLIER

Double - Pas de 7 x 150 - Finition zinguée blanche
- suite



	DÉSIGNATION	UT	CODE	PPHT (€)	ECOPART (€)
907.0014.56	COLLIER DOUBLE D.16 7X150 -BTE50-ING A512222	U	29406.6	20,81	0,01
907.0014.62	COLLIER DOUBLE D.18 7X150 -BTE50-ING A512224	U	29441.3	20,89	0,01
907.0015.57	COLLIER DOUBLE D.20 7X150 -BTE50-ING A512226	U	29448.8	22,26	0,01
907.0018.28	COLLIER DOUBLE D.22 7X150 -BTE50-ING A512228	U	2944J.5	26,13	0,01

I.N.G. FIXATIONS

COLLIER

Double - Pas de 7 x 150 - Acier revêtement blanc



	DÉSIGNATION	UT	CODE	PPHT (€)	ECOPART (€)
907.0030.92	COLLIER DOUBLE D 16 AC.BLC -BTE50-ING A141655	U	302JF.7	44,18	0,01
907.0033.23	COLLIER DOUBLE D 20 AC.BLC -BTE50-ING A141660	U	302JJ.0	47,48	0,01

I.N.G. FIXATIONS

COLLIER

Double - Pas de 7 x 150 -
Isophonique - Finition zinguée blanche



	DÉSIGNATION	UT	CODE	PPHT (€)	ECOPART (€)
907.0019.52	COLLIER DOUBLE ISO D.12 -BTE50-ING A512415	U	212TR.3	27,90	0,01
907.0021.11	COLLIER DOUBLE ISO D.14 -BTE50-ING A512418	U	2966B.4	30,16	0,01
907.0021.22	COLLIER DOUBLE ISO D.16 -BTE50-ING A512420	U	2966C.2	30,32	0,01
907.0024.21	COLLIER DOUBLE ISO D.18 -BTE50-ING A512422	U	2968B.2	34,59	0,01
907.0025.84	COLLIER DOUBLE ISO D.20 -BTE50-ING A512424	U	212TT.9	36,93	0,01
907.0015.23	COLLIER DOUBLE ISO D.22 -BTE25-ING A512426	U	2969E.4	21,77	0,01
907.0016.98	COLLIER DOUBLE ISO D.28 -BTE25-ING A512430	U	212TW.2	24,27	0,01

I.N.G. FIXATIONS

COLLIER

Électricien - Noir



	DÉSIGNATION	UT	CODE	PPHT (€)	ECOPART (€)
907.0042.97	COLLIER ELECT.9X290 NOIR-SACH.100-ING A280010	U	6589C.0	42,98	0,01
907.0054.78	COLLIER ELECT.9X380 NOIR-SACH.100-ING A280020	U	25946.5	54,79	0,01

I.N.G. FIXATIONS

COLLIER

Électricien - Blanc



	DÉSIGNATION	UT	CODE	PPHT (€)	ECOPART (€)
907.0140.17	COLLIER AERAIL.9X910 BLC -SAC100-ING A280350	U	238NR.8	140,18	0,01

Le PPHT comprend l'ecopart (€)

SUPPORTAGE ET FIXATION

FIXATION

I.N.G. FIXATIONS

COLLIER

Électricien - Fix-Tub Elec pour la fixation de tube IRO



	DÉSIGNATION	UT	CODE	PPHT (€)	ECOPART (€)
907.0026.55	FIX-TUB ELECTRICIEN D.16-32 -S50 -ING A322010	U	170J3.5	26,56	0,01

I.N.G. FIXATIONS

COLLIER

Sanitaire simple - Revêtement blanc



	DÉSIGNATION	UT	CODE	PPHT (€)	ECOPART (€)
907.0022.59	COLLIER SIMPLE D.16 AC.BLC -BTE50-ING A141570	U	276X9.9	32,28	0,01
907.0024.35	COLLIER SIMPLE D.20 AC.BLC -BTE50-ING A141580	U	276XA.6	34,80	0,01
907.0025.73	COLLIER SIMPLE D.26 AC.BLC -BTE50-ING A141590	U	276XB.4	36,76	0,01

I.N.G. FIXATIONS

COLLIER

Sanitaire simple - Finition zinguée blanche (sachet)



	DÉSIGNATION	UT	CODE	PPHT (€)	ECOPART (€)
907.0005.14	COLLIER SIMPLE D.12 -SAC.20-ING A509800	U	3199F.2	7,35	0,01
907.0005.19	COLLIER SIMPLE D.14 -SAC.20-ING A509803	U	3199G.0	7,43	0,01
907.0005.31	COLLIER SIMPLE D.16 -SAC.20-ING A509806	U	3002K.0	7,60	0,01
907.0005.37	COLLIER SIMPLE D.18 -SAC.20-ING A509808	U	6077V.2	7,68	0,01
907.0005.43	COLLIER SIMPLE D.22 -SAC.20-ING A509812	U	3002L.8	7,77	0,01
907.0003.95	COLLIER SIMPLE D.28 -SAC.10-ING A509818	U	30034.3	5,66	0,01
907.0004.25	COLLIER SIMPLE D.32 -SAC.10-ING A509821	U	60787.9	6,08	0,01
907.0004.84	COLLIER SIMPLE D.40 -SAC.10-ING A509824	U	30035.0	6,92	0,01
907.0004.25	COLLIER SIMPLE D.50 -SAC.5-ING A509829	U	1331L.4	6,08	0,01

I.N.G. FIXATIONS

COLLIER

Sanitaire simple - Finition zinguée blanche (boîte)



	DÉSIGNATION	UT	CODE	PPHT (€)	ECOPART (€)
907.0016.65	COLLIER SIMPLE D.12 7X150 -BTE100-ING A512016	U	2944L.1	23,79	0,01
907.0016.48	COLLIER SIMPLE D.14 7X150 -BTE100-ING A512018	U	2946Y.4	23,55	0,01
907.0016.98	COLLIER SIMPLE D.16 7X150 -BTE100-ING A512022	U	2952H.7	24,27	0,01
907.0017.33	COLLIER SIMPLE D.18 7X150 -BTE100-ING A512024	U	2955T.3	24,76	0,01
907.0017.83	COLLIER SIMPLE D.20 7X150 -BTE100-ING A512026	U	2956B.6	25,48	0,01
907.0018.73	COLLIER SIMPLE D.22 7X150 -BTE100-ING A512028	U	2956Q.8	26,77	0,01
907.0020.03	COLLIER SIMPLE D.26 ZG 7X150 BTE100 A512034	U	212TY.8	28,63	0,01
907.0021.67	COLLIER SIMPLE D.28 7X150 -BTE100-ING A512036	U	2956R.6	30,97	0,01
907.0012.70	COLLIER SIMPLE D.32 7X150 -BTE50-ING A512040	U	2958F.5	18,15	0,01
907.0016.13	COLLIER SIMPLE D.40 7X150 -BTE50-ING A512052	U	2962D.4	23,06	0,01
907.0016.37	COLLIER SIMPLE D.42 7X150 -BTE50-ING A512054	U	212U0.6	23,39	0,01
907.0010.72	COLLIER SIMPLE D.50 7X150 -BTE25-ING A512060	U	29631.9	15,32	0,01

Le PPHT comprend l'ecopart (€)

SUPPORTAGE ET FIXATION

FIXATION

I.N.G. FIXATIONS

COLLIER

Sanitaire simple - Finition zinguée jaune (boîte)



	DÉSIGNATION	UT	CODE	PPHT (€)	ECOPART (€)
907.0019.80	COLLIER SIMPLE D.25 7X150 -BTE100-ING A501050	U	0167P.9	28,30	0,01

I.N.G. FIXATIONS

COLLIER

Sanitaire simple - Isolé, Finition zinguée blanche M7x150 (sachet)



	DÉSIGNATION	UT	CODE	PPHT (€)	ECOPART (€)
907.0006.26	COLLIER SIMPLE ISO D.14 -SAC.20-ING A509863	U	5941P.1	8,95	0,01
907.0006.50	COLLIER SIMPLE ISO D.16 -SAC.20-ING A509866	U	6081R.5	9,29	0,01
907.0006.61	COLLIER SIMPLE ISO D.18 -SAC.20-ING A509869	U	6081S.3	9,46	0,01
907.0006.97	COLLIER SIMPLE ISO D.22 -SAC.20-ING A509875	U	30037.6	9,96	0,01
907.0005.19	COLLIER SIMPLE ISO D.28 -SAC.10-ING A509877	U	76034.8	7,43	0,01

I.N.G. FIXATIONS

COLLIER

Sanitaire simple - Isolé, Finition zinguée blanche M7x150 (boîte)



	DÉSIGNATION	UT	CODE	PPHT (€)	ECOPART (€)
907.0015.04	COLLIER SIMPLE ISO D.50 -BTE25-ING A501600	U	72663.8	25,08	0,01

I.N.G. FIXATIONS

COLLIER

Sanitaire simple - Isolé, Finition zinguée jaune M7x150 (boîte)



	DÉSIGNATION	UT	CODE	PPHT (€)	ECOPART (€)
907.0019.75	COLLIER SIMPLE ISO D.10 ZG-BTE100-ING A512316	U	212U2.2	28,22	0,01
907.0021.67	COLLIER SIMPLE ISO D.12 ZG-BTE100-ING A512318	U	2969G.0	30,97	0,01
907.0024.04	COLLIER SIMPLE ISO D.14 ZG-BTE100-ING A512320	U	2971K.9	34,35	0,01
907.0024.04	COLLIER SIMPLE ISO D.16 ZG-BTE100-ING A512322	U	2972A.8	34,35	0,01
907.0024.61	COLLIER SIMPLE ISO D.18 ZG-BTE100-ING A512324	U	2973R.5	35,16	0,01
907.0027.43	COLLIER SIMPLE ISO D.20 ZG-BTE100-ING A512326	U	2975A.5	39,19	0,01
907.0028.78	COLLIER SIMPLE ISO D.22 ZG-BTE100-ING A512328	U	2979G.8	41,12	0,01
907.0016.59	COLLIER SIMPLE ISO D.26 ZG-BTE50-ING A512332	U	212U5.5	23,71	0,01
907.0017.94	COLLIER SIMPLE ISO D.28 ZG-BTE50-ING A512334	U	29994.1	25,64	0,01
907.0018.17	COLLIER SIMPLE ISO D.32 ZG-BTE50-ING A512338	U	30005.3	25,97	0,01
907.0022.29	COLLIER SIMPLE ISO D.40 ZG-BTE50-ING A512346	U	4389R.9	31,85	0,01
907.0022.51	COLLIER SIMPLE ISO D.42 ZG-BTE50-ING A512348	U	212U8.9	32,17	0,01

SUPPORTAGE ET FIXATION

FIXATION

I.N.G. FIXATIONS

COLLIER

Sanitaire double - Double



	DÉSIGNATION	UT	CODE	PPHT (€)	ECOPART (€)
907.0004.49	COLLIER DOUBLE D.14 -SAC.10-ING A509836	U	3199I.6	6,42	0,01
907.0004.61	COLLIER DOUBLE D.16 -SAC.10-ING A509839	U	3199J.5	6,59	0,01
907.0005.31	COLLIER DOUBLE D.22 -SAC.10-ING A509845	U	1318T.7	7,60	0,01

I.N.G. FIXATIONS

FIXATION

Pour Ballon d'eau chaude



	DÉSIGNATION	UT	CODE	PPHT (€)	ECOPART (€)
907.0008.77	FIXATION BALLON EAU CHAUDE 10X120 ING A500150	U	7395B.4	10,97	0,01

I.N.G. FIXATIONS

FIXATION

Pour Ballon d'eau chaude -
Plaquette filetée



	DÉSIGNATION	UT	CODE	PPHT (€)	ECOPART (€)
907.0018.70	FIXATION BALLON PLAQ.FIL.10X140 ING A500530	U	4848B.4	23,38	0,01

I.N.G. FIXATIONS

FIXATION

Fix-Ring - Simple - Perçage ø 8 mm



	DÉSIGNATION	UT	CODE	PPHT (€)	ECOPART (€)
907.0029.24	ATTACHE FIX-RING SPLE 16 -BTE100-ING A300050	U	73184.4	38,99	0,01
907.0030.94	ATTACHE FIX-RING SPLE 18 -BTE100-ING A300100	U	73185.1	41,26	0,01
907.0031.48	ATTACHE FIX-RING SPLE 20 -BTE100-ING A300200	U	73186.9	41,98	0,01
907.0034.42	ATTACHE FIX-RING SPLE 22 -BTE100-ING A300300	U	73187.7	45,90	0,01
907.0035.26	ATTACHE FIX-RING SPLE 25 -BTE100-ING A300400	U	73188.5	47,03	0,01
907.0042.30	ATTACHE FIX-RING SPLE 28 -BTE100-ING A300500	U	73315.4	56,41	0,01
907.0021.78	ATTACHE FIX-RING SPLE 32 -BTE 50-ING A300600	U	9554C.5	36,31	0,01

I.N.G. FIXATIONS

FIXATION

Fix-Ring - Double - Perçage ø 8 mm



	DÉSIGNATION	UT	CODE	PPHT (€)	ECOPART (€)
907.0034.18	ATTACHE FIX-RING DBLE 16 -BTE100-ING A301650	U	81056.4	45,59	0,01
907.0039.68	ATTACHE FIX-RING DBLE 20 -BTE100-ING A301750	U	73191.9	52,91	0,01
907.0044.55	ATTACHE FIX-RING DBLE 22 -BTE100-ING A301800	U	81057.2	59,41	0,01
907.0047.48	ATTACHE FIX-RING DBLE 25 -BTE100-ING A301850	U	56638.0	63,32	0,01
907.0032.40	ATTACHE FIX-RING DBLE 28 -BTE 50-ING A301900	U	07743.8	43,21	0,01
907.0020.30	ATTACHE FIX-RING DBLE 40 -BTE.20-ING A301910	U	300FU.7	27,07	0,01

SUPPORTAGE ET FIXATION

FIXATION

I.N.G. FIXATIONS

FIXATION

Fix-Ring multi - Double



	DÉSIGNATION	UT	CODE	PPHT (€)	ECOPART (€)
907.0035.52	ATTACHE FIX-RING MULTI DBLE16/20 -50- A332000	U	248M9.3	47,37	0,01

I.N.G. FIXATIONS

FIXATION

Fix-Ring multi - Quadruple



	DÉSIGNATION	UT	CODE	PPHT (€)	ECOPART (€)
907.0028.60	ATTACHE FIX-RING MULTI QUAD16/20 -25- A332100	U	248MA.0	38,14	0,01

I.N.G. FIXATIONS

FIXATION

Eléments sanitaires - Plaquette zinguée - Sans
cheville



	DÉSIGNATION	UT	CODE	PPHT (€)	ECOPART (€)
907.0001.72	PLAQUETTE SANITAIRE EP.3MM -1- ING A150236	U	8828R.9	2,16	0,01

I.N.G. FIXATIONS

FIXATION

Rosace conique - Revêtement blanc



	DÉSIGNATION	UT	CODE	PPHT (€)	ECOPART (€)
907.0007.97	ROSACE CONIQUE 9X28 ACIER BLC-50-ING A1412520	U	276X6.5	11,39	0,01
907.0011.74	ROSACE CONIQUE 14X32 ACIER BLC-50-ING A141525	U	276X7.3	16,78	0,01

I.N.G. FIXATIONS

FIXATION

Rosace conique - Zinguée blanche



	DÉSIGNATION	UT	CODE	PPHT (€)	ECOPART (€)
907.0007.08	ROSACE CONIQUE 9X28 ZINGUE -100- ING A512514	U	166T0.5	10,13	0,01
907.0009.09	ROSACE CONIQUE 14X32 ZINGUE -100- ING A512516	U	166T2.1	12,99	0,01
907.0012.19	ROSACE CONIQUE 19X38 ZG.BLC -100- ING A512518	U	166T7.0	17,42	0,01
907.0019.75	ROSACE CONIQUE 24X42 ZG.BLC -100- ING A512520	U	166T8.8	28,22	0,01

Le PPHT comprend l'ecopart (€)

SUPPORTAGE ET FIXATION

FIXATION

I.N.G. FIXATIONS

FIXATION

Rosace conique - Gamme sanitaire en sachet



	DÉSIGNATION	UT	CODE	PPHT (€)	ECOPART (€)
907.0004.30	ROSACE CONIQUE 9 -SACH.20- ING A509887	U	31653.9	4,30	
907.0007.67	ROSACE CONIQUE 24 -SACH.20- ING A509893	U	31631.8	7,68	0,01
907.0003.54	ROSACE CONIQUE 14 -SACH.20- ING A509890	U	3003E.0	5,06	
907.0004.25	ROSACE CONIQUE 19 -SACH.20-ING A509891	U	6678K.6	6,08	0,01

I.N.G. FIXATIONS

FIXATION

Rosace plate - Revêtement blanc



	DÉSIGNATION	UT	CODE	PPHT (€)	ECOPART (€)
907.0010.05	ROSACE PLATE D.32 AC.BLANC -BTE50-ING A141550	U	276X8.1	14,36	0,01

I.N.G. FIXATIONS

FIXATION

Rosace plate - Zinguée blanche



	DÉSIGNATION	UT	CODE	PPHT (€)	ECOPART (€)
907.0007.56	ROSACE PLATE D.25 Z6.BLC -BTE100- ING A512530	U	212V1.3	10,80	

I.N.G. FIXATIONS

FIXATION

Piton suspension béton - Rapido - Plombier / Electricien



	DÉSIGNATION	UT	CODE	PPHT (€)	ECOPART (€)
907.0037.29	PITON RAPIDO M8 -BTE 100- ING A188150	U	74971.3	74,59	0,01

I.N.G. FIXATIONS

FIXATION

WC et Bidet



	DÉSIGNATION	UT	CODE	PPHT (€)	ECOPART (€)
907.0005.33	FIXATION WC/BIDET 6X70 CAP.CHR. ING A500200	U	7391B.8	6,66	
907.0006.07	FIXATION WC/BIDET 6X80 CAP.CHR. ING A500210	U	71827.0	7,59	

I.N.G. FIXATIONS

FIXATION

WC et Bidet - Cheville longue et double capuchon



	DÉSIGNATION	UT	CODE	PPHT (€)	ECOPART (€)
907.0005.40	FIXATION WC/BIDET 6X60 LONG+CAP. ING A500220	U	75846.6	6,75	

Le PPHT comprend l'ecopart (€)

SUPPORTAGE ET FIXATION

FIXATION

I.N.G. FIXATIONS

FIXATION

Console lavabo - Standard



	DÉSIGNATION	UT	CODE	PPHT (€)	ECOPART (€)
907.0037.31	CONSOLE LAVABO L210 -PAIRE- ING A186145	U	353TP.9	46,65	0,01
907.0043.41	CONSOLE LAV.ALU L6220 -PAIRE- ING A186210	U	6884X.1	54,27	0,01

I.N.G. FIXATIONS

FIXATION

Console lavabo - Réglable - Perçages Ø7 mm



	DÉSIGNATION	UT	CODE	PPHT (€)	ECOPART (€)
907.0039.96	CONSOLE LAVABO REGLABLE -PAIRE- ING A186350	U	353TR.5	49,96	0,01

I.N.G. FIXATIONS

FIXATION

Console lavabo collectif



	DÉSIGNATION	UT	CODE	PPHT (€)	ECOPART (€)
907.0096.28	CONSOLE LAV.COLLECT.LARGE -PAIRE- ING A186302	U	248HP.7	120,36	0,01

I.N.G. FIXATIONS

FIXATION

Lavabo et WC suspendu - Rondelle excentrée



	DÉSIGNATION	UT	CODE	PPHT (€)	ECOPART (€)
907.0003.84	FIXATION LAV./WC SUSP.8X90 EXC. ING A500080	U	94824.0	4,80	
907.0003.98	FIXATION LAV./WC SUSP.8X110 EXC. ING A500090	U	1148T.3	4,97	
907.0004.72	FIXATION LAV./WC SUSP.10X100 EXC. ING A500100	U	71719.9	5,91	0,01
907.0005.13	FIXATION LAV./WC SUSP.10X120 EXC. ING A500110	U	71733.0	6,42	0,01
907.0005.46	FIXATION LAV./WC SUSP.10X140 EXC. ING A500120	U	71749.6	6,84	0,01

I.N.G. FIXATIONS

FIXATION

Lavabo - Avec plaquette fileté



	DÉSIGNATION	UT	CODE	PPHT (€)	ECOPART (€)
907.0008.43	FIXATION LAV.PLAQ.FIL.8X90 EXC. ING A500500	U	7396B.3	10,55	0,01
907.0009.04	FIXATION LAV.PLAQ.FIL.8X110 EXC. ING A500505	U	7397B.2	11,31	0,01
907.0010.12	FIXATION LAV.PLAQ.FIL.10X110 EXC. ING A500520	U	71901.3	12,66	0,01

SUPPORTAGE ET FIXATION

FIXATION

I.N.G. FIXATIONS

FIXATION

Raccord de jonction - Mâle / mâle - Zingué jaune



	DÉSIGNATION	UT	CODE	PPHT (€)	ECOPART (€)
907.0005.43	RACCORD JONCT.MM M7/M7 JNE-SAC10- ING A140262	U	6318V.1	7,76	
907.0070.08	RACCORD JONCT.MM M7/M7 JNE-BTE100-ING A140263	U	210MY.3	70,09	0,01
907.0007.76	RACCORD JONCT.MM M8/M8 JNE-SAC10- ING A140266	U	3911B.8	7,76	

I.N.G. FIXATIONS

FIXATION

Raccord de jonction - Mâle / femelle - Zingué blanc



	DÉSIGNATION	UT	CODE	PPHT (€)	ECOPART (€)
907.0050.37	RACCORD JONCT.MF M8/M7 BLC-BTE100-ING A140318	U	210N6.8	67,17	0,01
907.0006.14	RACCORD JONCT.MF M8/M7 BLC-SAC10- ING A140320	U	6885P.7	8,77	

I.N.G. FIXATIONS

FIXATION

Support de radiateur à sceller - Pour radiateur fonte traditionnel



	DÉSIGNATION	UT	CODE	PPHT (€)	ECOPART (€)
907.0006.81	SUPPORT RADIATEUR A SCEL.290MM -1-ING A186085	U	9288R.0	8,52	0,01

I.N.G. FIXATIONS

VIS

Vis métaux - Tête ronde zinguée

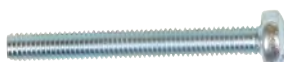

	DÉSIGNATION	UT	CODE	PPHT (€)	ECOPART (€)
907.0008.81	VIS METAL TETE RONDE 5X43 -BTE100-ING A506450	U	63797.5	14,69	0,01
907.0018.67	VIS METAL TETE RONDE 5X67 -BTE100-ING A506460	U	72355.1	24,90	0,01
907.0013.17	VIS METAL TETE RONDE 6X43 -BTE100-ING A506480	U	63816.3	18,82	0,01
907.0016.12	VIS METAL TETE RONDE 6X57 -BTE100-ING A506485	U	63823.9	23,04	0,01
907.0022.46	VIS METAL TETE RONDE 6X67 -BTE100-ING A506490	U	6354H.2	29,96	0,01



COLLIER

De fixation - Collclip Simple



	DÉSIGNATION	UT	CODE	PPHT (€)
239.0037.50	COLLIER PL.BL.COLLLIP SPL-SC100 CLIP1222B	U	4751C.7	50,00

SUPPORTAGE ET FIXATION

FIXATION



COLLIER

De fixation - Collclip Double



	DÉSIGNATION	UT	CODE	PPHT (€)
000.0044.25	COLLIER PL.BL.COLLLIP DBL -BT100- CLIPD1222B	U	4751R.9	59,00



CHEVILLE METAL

Driva - Cheville autoforeuse ultra rapide spéciale plâtre, Zamak - Driva TP12



	DÉSIGNATION	UT	CODE	PPHT (€)
886.0036.23	CHEVILLE DRIVA TP12 -BTE100-SPIT 059360	U	95762.1	45,29



CHEVILLE METAL

Fix 3 - Cheville à expansion par vissage pour béton, acier zingué - Avec écrous et rondelles prémontés



	DÉSIGNATION	UT	CODE	PPHT (€)
886.0039.58	GOUJON FIX3 8X55/5MT -BTE100- SPIT 057450	U	0670S.3	49,48
886.0054.36	GOUJON FIX3 8X70/20-10MT -BTE100- SPIT 057451	U	0670U.8	54,36
886.0028.38	GOUJON FIX3 8X90/40-30MT -BTE50- SPIT 057452	U	0670W.4	28,38
886.0042.91	GOUJON FIX3 8X130/80-70MT -BTE50- SPIT 057455	U	0671M.2	42,91
886.0038.65	GOUJON FIX3 10X75/15-5MT -BTE50- SPIT 057461	U	0671P.8	38,65
886.0045.29	GOUJON FIX3 10X95/36-26MT -BTE50- SPIT 057463	U	0671Q.6	45,29
886.0039.28	GOUJON FIX3 12X140/65-50MT -B2S- SPIT 057474	U	0671Y.9	39,28



CHEVILLE METAL

Spit Laiton - Cheville Femelle pour maçonnerie pleine



	DÉSIGNATION	UT	CODE	PPHT (€)
886.0038.87	CHEVILLE LAITON M8X28 -BTE100-SPIT 062460	U	95464.4	48,59



CHEVILLE METAL

Grip+ L - Cheville Femelle haute performance pour béton



	DÉSIGNATION	UT	CODE	PPHT (€)
886.0054.06	CHEVILLE GRIP L M8X30 ETE -BTE100-SPIT 058583	U	337A3.9	54,06

Le PPHT comprend l'ecopart (€)

SUPPORTAGE ET FIXATION

FIXATION



CHEVILLE PLASTIQUE

Arpon - Cheville spéciale matériaux creux, polypropylène



	DÉSIGNATION	UT	CODE	PPHT (€)
886.0027.82	CHEVILLE ARPON 8X30 -BID350-SPIT 055724	U	6857D.3	27,82
886.0026.58	CHEVILLE ARPON 8X30 PAV -BID350-SPIT 057479	U	9902C.4	33,23
886.0091.14	CHEVILLE ARPON 8X30 PAV -BID1200-SPIT 055726	U	1089H.5	113,93



CHEVILLE PLASTIQUE

Arpon - Cheville spéciale matériaux creux, polypropylène - En grappe



	DÉSIGNATION	UT	CODE	PPHT (€)
886.0005.15	CHEVILLE ARPON 6X25 -BTE100-SPIT 198160	U	95389.3	6,44
886.0006.37	CHEVILLE ARPON 8X30 -BTE100-SPIT 198180	U	95390.1	7,96
886.0007.62	CHEVILLE ARPON 8X30 PAV -BTE100-SPIT 198190	U	95391.9	9,52



CHEVILLE PLASTIQUE

Colortech - Bimatière - Sans vis



	DÉSIGNATION	UT	CODE	PPHT (€)
886.0056.40	CHEVILLE COLORTECH 6X35 SS.VIS -500- 569248	U	251BE.6	56,40



CHEVILLE PLASTIQUE

EASYMIX - Cheville mécano-chimique pour béton, maçonneries pleines et creuses - Avec vis zinguée



	DÉSIGNATION	UT	CODE	PPHT (€)
880.0034.68	CHEVILLE EASYMIX M8X140/30 -BL.4-SPIT 060230	U	3182Z.2	34,68
880.0036.60	CHEVILLE EASYMIX M10X140/30 -BL.4-SPIT 060231	U	318YY.8	36,60



CHEVILLE PLASTIQUE

Nylon - Cheville haute résistance (idéale pour matériaux pleins) - Avec collerette



	DÉSIGNATION	UT	CODE	PPHT (€)
886.0006.78	CHEVILLE NYLON 8X40 COL -BTE100-SPIT 057090	U	95379.4	8,48
886.0025.41	CHEVILLE NYLON 8X40 COL -BID300- SPIT 056717	U	54238.1	25,41
886.0084.73	CHEVILLE NYLON 8X40 COL -BID1000- SPIT 055718	U	6856K.0	84,73

SUPPORTAGE ET FIXATION

FIXATION



CHEVILLE PLASTIQUE

Hit-M nylon - Cheville à frapper tous matériaux - Douille plate - clou-vis zingué



	DÉSIGNATION	UT	CODE	PPHT (€)
886.0020.87	CHEVILLE HITM 6-30/5P -BTE200-SPIT 050118	U	1246B.8	27,83
886.0027.82	CHEVILLE HITM 6-30/5P -BID.250-SPIT 055702	U	4980K.4	34,78
886.0037.99	CHEVILLE HITM 5-25/5P -BID.400-SPIT 055701	U	4980I.7	47,49
886.0139.10	CHEVILLE HITM 6-30/5P -BID.1000-SPIT 055704	U	9220I.6	139,10



ACCESSOIRES VISSERIE

Goujon d'ancrage pour béton fissuré FIX3 - Cheville de qualité avec ETE pour applications standards



	DÉSIGNATION	UT	CODE	PPHT (€)
000.0050.99	GOUJON FIX3 8X70/20-10 -BID.75- SPIT 059067	U	320AQ.9	50,99



SCELLEMENT CHIMIQUE

ID-ALL système de scellement pour matériaux creux - Résine de scellement - Application : chauffe-eau



	DÉSIGNATION	UT	CODE	PPHT (€)
880.0061.36	KIT FIXATION ID-ALL CHAUF-EAU M10 SPIT 059506	U	2501H.3	61,36



SCELLEMENT CHIMIQUE

ID-ALL système de scellement pour matériaux creux - Résine de scellement - Application : climatisation



	DÉSIGNATION	UT	CODE	PPHT (€)
880.0059.25	KIT FIXATION ID-ALL SUPP.CLIM M8 SPIT 059508	U	2501K.8	59,25



SCELLEMENT CHIMIQUE

Consommable - ID-ALL



	DÉSIGNATION	UT	CODE	PPHT (€)
880.0032.34	KIT FIXATION ID-ALL 20 + 4 BUSES SPIT 055896	U	6109N.9	40,42



SCELLEMENT CHIMIQUE

Buse - Standard



	DÉSIGNATION	UT	CODE	PPHT (€)
880.0014.58	BUSE D'INJECTION CM12L -SAC10- SPIT 050882	U	22467.5	18,23

SUPPORTAGE ET FIXATION

FIXATION

spit **Paslode**

SCELLEMENT CHIMIQUE

C-Mix Plus - Résine de scellement polyester - Temps de séchage très rapide



	DÉSIGNATION	UT	CODE	PPHT (€)
880.0009.34	CARTOUCHE CMIXPLUS 300ML+2B PIER. SPIT 055865	U	7661E.4	11,68
880.0009.34	CARTOUCHE CMIXPLUS 300ML+2B SPIT 055866	U	5421G.5	11,68

spit **Paslode**

SCELLEMENT CHIMIQUE

Tamis plastique - M6 - M8



	DÉSIGNATION	UT	CODE	PPHT (€)
880.0004.54	TAMIS EPOMIX 12X45 PLAS -BTE10- SPIT 565012	U	53541.9	5,67
880.0004.94	TAMIS EPOMIX 15X85 PLAS -BTE10- SPIT 567070	U	52472.8	6,18

VOTRE ESPACE PRO, LA CLÉ DE TOUS VOS SUCCÈS !



MON ESPACE PRO



Devis, factures
et suivi de commandes



Actus promos
et déstockages



Services dédiés
aux pros



Guides et conseils



Accès aux
Gammes Exclusives



Téléchargement
de nos catalogues



Rendez-vous vers
votre espace pro

www.richardson.fr



L'ATOUT SÉRÉNITÉ DE VOS CHANTIERS

REMS

for Professionals

depuis
1909



Pour plus d'informations : FRA@rems.de



www.rems.de



@remstools_france



@remstools

| 360 |

J+0 100% Dispo www.richardson.fr

Outillage

SOMMAIRE

OUTILLAGE PLOMBIER

OUTILS DE SERTISSAGE	362
OUTILS DE FAÇONNAGE DU TUBE	363
OUTILS DE SERRAGE	364
OUTILS DE COUPE ET SCIAGE	365
OUTILS DE CINTRAGE	366
OUTILS DE FILETAGE	366
OUTILS D'ÉBAVURAGE ET CALIBRAGE	366
OUTILS DE SOUDAGE, BRASAGE ET ÉTANCHEITÉ	367
OUTILS DE MAINTENANCE ET RÉPARATION	370

OUTILLAGE CARRELEUR

OUTILS DE MALAXAGE	371
OUTILS DE POSE	371
ACCESSOIRES DE POSE	371
ACCESSOIRES DE NETTOYAGE	372

OUTILLAGE FRIGORISTE

OUTILS DE RACCORDEMENT	372
CHARGE/DÉCHARGE DE GAZ	373
OUTILS DE MESURE ET CONTRÔLE	374

OUTILLAGE UNIVERSEL

OUTILS À MAIN	375
RANGEMENT POUR OUTILS	378
OUTILS POUR BATIMENT	379
ÉQUIPEMENT	379

OUTILLAGE ELECTROPORTATIF

OUTILS DE PERÇAGE ET BURINAGE	381
ACCESSOIRES PERÇAGE ET BURINAGE	381
OUTILS DE FORAGE ET CAROTTAGE	384
ACCESSOIRES FORAGE ET CAROTTAGE	384
OUTILS DE COUPE	385
ACCESSOIRES DE COUPE	385
ACCESSOIRES DE CLOUAGE	387
OUTILS SPÉCIFIQUES	387

MESURE ET CONTRÔLE

OUTILS DE MESURE	388
OUTILS DE CONTRÔLE	389

SECURITE ET PROTECTION

PROTECTION DE LA PERSONNE	390
---------------------------------	-----

OUTILLAGE PLOMBIER

OUTILS DE SERTISSAGE



SERTISSEUSE

Force Logic - M12 HPT



	DÉSIGNATION	UT	CODE	PPHT (€)	ECOPART (€)
884.1588.99	SERTISSEUSE M12 HPT-202C TH-SET 4933443105	U	214TE.2	1589,41	0,42



SERTISSEUSE ELECTRIQUE PAR ECRASEMENT

Mini-Press - Électrohydraulique 22 V ACC - Avec retour automatique



	DÉSIGNATION	UT	CODE	PPHT (€)	ECOPART (€)
000.1826.88	SERTISSEUSE MINI-PRESS 22V L-BOXX 578014 R220	U	37147.6	1827,23	0,35



ACCESSOIRES SERTISSEUSE

Pince à sertir - Pour sertisseuse radiale - Profil V



	DÉSIGNATION	UT	CODE	PPHT (€)
000.0154.61	PINCE A SERTIR V 12 REMS 570107	U	40039.0	154,61
000.0154.61	PINCE A SERTIR V 18 REMS 570125	U	40069.7	154,61
000.0154.61	PINCE A SERTIR V 22 REMS 570135	U	40076.2	154,61
000.0154.61	PINCE A SERTIR V 28 REMS 570145	U	40074.7	154,61



ACCESSOIRES SERTISSEUSE

Pince à sertir - Pour sertisseuse radiale - Profil VG



	DÉSIGNATION	UT	CODE	PPHT (€)
000.0154.61	PINCE A SERTIR VG 14 REMS 570132	U	88848.0	154,61
000.0154.61	PINCE A SERTIR VG 16 REMS 570137	U	88858.9	154,61



ACCESSOIRES SERTISSEUSE

Pince à sertir - Pour sertisseuse radiale - Profil G



	DÉSIGNATION	UT	CODE	PPHT (€)
000.0186.79	PINCE A SERTIR G16 REMS 570400	U	03036.1	186,79
000.0198.21	PINCE A SERTIR G26 REMS 570420	U	0303A.2	198,21
000.0211.70	PINCE A SERTIR G32 REMS 570430	U	3747L.8	211,70

OUTILLAGE PLOMBIER

OUTILS DE SERTISSAGE



ACCESSOIRES SERTISSEUSE

Pince à sertir - Pour sertisseuse radiale - Profil M



	DÉSIGNATION	UT	CODE	PPHT (€)
000.0154.61	PINCE A SERTIR M22 REMS 570130	U	0302I.6	154,61
000.0154.61	PINCE A SERTIR M35 REMS 570150	U	0302K.3	154,61



ACCESSOIRES SERTISSEUSE

Pince à sertir - Pour sertisseuse radiale - Profil TH



	DÉSIGNATION	UT	CODE	PPHT (€)
000.0186.32	PINCE A SERTIR TH16 REMS 570460	U	44088.3	186,32
000.0186.32	PINCE A SERTIR TH20 REMS 570470	U	44102.2	186,32
000.0186.32	PINCE A SERTIR TH26 REMS 570475	U	44135.2	186,32
000.0186.32	PINCE A SERTIR TH32 REMS 570480	U	89471.7	186,32
000.0246.99	PINCE A SERTIR TH40 REMS 570485	U	8025D.6	246,99
000.0645.58	PINCE A SERTIR TH50 REMS 572400	U	8025F.1	645,58
000.0645.58	PINCE A SERTIR TH63 REMS 572405	U	6586L.5	645,58



ACCESSOIRES SERTISSEUSE

Pince à sertir - Pour sertisseuse radiale - Profil U



	DÉSIGNATION	UT	CODE	PPHT (€)
000.0298.89	PINCE A SERTIR U50 REMS 570795	U	0380G.5	298,89



ACCESSOIRES SERTISSEUSE

Pince à sertir MINI - Pour sertisseuse radiale Mini-Press ACC - Profil VG



	DÉSIGNATION	UT	CODE	PPHT (€)
000.0146.98	PINCE A SERTIR MINI VG 14 REMS 578338	U	1937E.5	146,98
000.0146.98	PINCE A SERTIR MINI VG 16 REMS 578340	U	1937G.1	146,98



ACCESSOIRES SERTISSEUSE

Pince à sertir MINI - Pour sertisseuse radiale Mini-Press ACC - Profil BMP



	DÉSIGNATION	UT	CODE	PPHT (€)
000.0175.53	PINCE A SERTIR MINI BMP 1/4" REMS 578700	U	266H7.4	175,53
000.0175.53	PINCE A SERTIR MINI BMP 3/8" REMS 578702	U	266H8.2	175,53
000.0175.53	PINCE A SERTIR MINI BMP 1/2" REMS 578704	U	254WN.8	175,53
000.0175.53	PINCE A SERTIR MINI BMP 5/8" REMS 578706	U	266H9.0	175,53
000.0175.53	PINCE A SERTIR MINI BMP 3/4" REMS 578708	U	266HA.7	175,53

Le PPHT comprend l'ecopart (€)

OUTILLAGE PLOMBIER

OUTILS DE SERTISSAGE

REMS
100% Professionnels

ACCESSOIRES SERTISSEUSE

Pince à sertir MINI - Pour sertisseuse radiale Mini-Press ACC - Profil BMP
- suite



	DÉSIGNATION	UT	CODE	PPHT (€)
000.0175.53	PINCE A SERTIR MINI BMP 1"1/8 REMS 578714	U	266HD.1	175,53

REMS
100% Professionnels

ACCESSOIRES SERTISSEUSE

Pince à sertir MINI - Pour sertisseuse radiale Mini-Press ACC - Profil V



	DÉSIGNATION	UT	CODE	PPHT (€)
000.0146.98	PINCE A SERTIR MINI V 12 REMS 578324	U	0873D.6	146,98
000.0146.98	PINCE A SERTIR MINI V 15 REMS 578328	U	0873E.3	146,98
000.0146.98	PINCE A SERTIR MINI V 18 REMS 578332	U	0873G.9	146,98
000.0146.98	PINCE A SERTIR MINI V 22 REMS 578334	U	0873F.1	146,98
000.0146.98	PINCE A SERTIR MINI V 28 REMS 578336	U	0873H.7	146,98
000.0178.12	PINCE A SERTIR MINI V 35 REMS 578604	U	5474K.4	178,12

REMS
100% Professionnels

ACCESSOIRES SERTISSEUSE

Pince à sertir MINI - Pour sertisseuse radiale Mini-Press ACC - Profil M



	DÉSIGNATION	UT	CODE	PPHT (€)
000.0146.98	PINCE A SERTIR MINI M 18 REMS 578314	U	1937A.4	146,98
000.0146.98	PINCE A SERTIR MINI M28 REMS 578318	U	1937D.8	146,98

REMS
100% Professionnels

ACCESSOIRES SERTISSEUSE

Pince à sertir MINI - Pour sertisseuse radiale Mini-Press ACC - Profil RFZ



	DÉSIGNATION	UT	CODE	PPHT (€)
000.0184.45	PINCE A SERTIR MINI RFZ 20 REMS 578494	U	3390J.2	184,45
000.0184.45	PINCE A SERTIR MINI RFZ 12 REMS 578490	U	3202S.9	184,45
000.0184.45	PINCE A SERTIR MINI RFZ 16 REMS 578492	U	32029.1	184,45

REMS
100% Professionnels

ACCESSOIRES SERTISSEUSE

Pince à sertir MINI - Pour sertisseuse radiale Mini-Press ACC - Profil TH



	DÉSIGNATION	UT	CODE	PPHT (€)
000.0170.60	PINCE A SERTIR MINI TH16 REMS 578352	U	3869C.8	170,60

Le PPHT comprend l'ecopart (€)

OUTILLAGE PLOMBIER

OUTILS DE SERTISSAGE

REMS
100% Professionnels

ACCESSOIRES SERTISSEUSE

Pince à sertir MINI - Pour sertisseuse radiale Mini-Press ACC - Profil TH



	DÉSIGNATION	UT	CODE	PPHT (€)
000.0170.60	PINCE A SERTIR MINI TH20 REMS 578358	U	3869D.6	170,60
000.0170.60	PINCE A SERTIR MINI TH26 REMS 578362	U	28932.2	170,60
000.0177.08	PINCE A SERTIR MINI TH32 REMS 578364	U	4579K.1	177,08
000.0234.69	PINCE A SERTIR MINI TH40 REMS 578624	U	9986E.8	234,69

REMS
100% Professionnels

ACCESSOIRES SERTISSEUSE

Pince à sertir MINI - Pour sertisseuse radiale Mini-Press ACC - Set



	DÉSIGNATION	UT	CODE	PPHT (€)
000.0848.46	PINCE MINI BMP 1/4-3/8-1/2-5/8" REMS 578090 R	U	264FJ.6	848,46
000.1550.56	PINCE SERT.MINI SET BMP 1/4-1"1/8 578091 R	U	322B6.3	1550,56

REMS
100% Professionnels

ACCESSOIRES SERTISSEUSE

Accumulateur, chargeur - Accumulateur



	DÉSIGNATION	UT	CODE	PPHT (€)	ECOPART (€)
000.0258.46	BATTERIE LI-ION 21.6V 2.5AH REMS 571571R22	U	87343.0	258,68	0,22
000.0227.32	BATTERIE LI-ION+ 14.4V 3.0AH REMS 571555R14	U	180WJ.3	227,55	0,23

virax

ACCESSOIRES SERTISSEUSE

Inserts pour modèles i10 / i11 / i20 / i21 / m20+ / m21+ - Standard



	DÉSIGNATION	UT	CODE	PPHT (€)
000.0081.00	INSERT TYPE TH 26 STANDARD VIRAX 252909	U	42447.3	81,00

OUTILS DE FAÇONNAGE DU TUBE

virax

APPAREIL A BATTRE LES COLLETS

Matrice



	DÉSIGNATION	UT	CODE	PPHT (€)
887.0089.01	MATRICE 90D 10-22MM +14 VIRAX 250413	U	5323S.8	98,90

OUTILLAGE PLOMBIER

OUTILS DE SERRAGE



CLE SERRE-TUBE ET PINCE MULTIPRISE

Pince multiprise - Alligator



DÉSIGNATION	UT	CODE	PPHT (€)
889.0023.85 PINCE MULTIPRISE ALLIGATOR 250MM 88 01 250	U	1199A.7	23,85



CLE SERRE-TUBE ET PINCE MULTIPRISE

Pince multiprise - Cobra



DÉSIGNATION	UT	CODE	PPHT (€)
889.0027.50 PINCE MULTIPRISE COBRA 125MM 87 01 125	U	64710.7	27,50
889.0028.20 PINCE MULTIPRISE COBRA 150MM 87 01 150	U	7921C.5	28,20
889.0029.60 PINCE MULTIPRISE COBRA 180MM 87 01 180	U	1211A.1	29,60
889.0031.40 PINCE MULTIPRISE COBRA 250MM 87 01 250	U	1214A.8	31,40
889.0043.75 PINCE MULTIPRISE COBRA 300MM 87 01 300	U	1217A.5	43,75
889.0076.50 PINCE MULTIPRISE COBRA 400MM 87 01 400	U	1208A.6	76,50
889.0127.95 PINCE MULTIPRISE COBRA 560MM 87 01 560	U	1220A.0	127,95



OUTILS RADIATEUR

Clé de montage - Etagée - Avec cliquet



DÉSIGNATION	UT	CODE	PPHT (€)
887.0066.60 CLE A CLIQUET 4 TAILL.3/8 A 1 VIRAX 220425	U	07023.5	74,00
887.0049.50 CLE DE MONTAGE 4T.3/8-1 VIRAX 220420	U	40819.5	55,00



OUTILS RADIATEUR

Barre de montage - Carré d'entraînement de 18 mm



DÉSIGNATION	UT	CODE	PPHT (€)
887.0049.50 BARRE DE MONTAGE 26X34 800 VIRAX 220308	U	12043.6	55,00



OUTILS DE SERRAGE

Clé à bonde - Tête amovible



DÉSIGNATION	UT	CODE	PPHT (€)
887.0100.08 CLE A BONDE AVEC TETE VIRAX 261620	U	66104.1	111,20

OUTILLAGE PLOMBIER

OUTILS DE SERRAGE



OUTILS DE SERRAGE

Clé écrou robinet - Clé + 6 embouts



DÉSIGNATION	UT	CODE	PPHT (€)
887.0044.10 CLE ECROU ROBINET+6 EMBOUTS VIRAX 261470	U	1390E.5	49,00



SERRE-TUBE

Clé Viragrip - Mâchoire fixe - Bec de canard



DÉSIGNATION	UT	CODE	PPHT (€)
887.0198.90 CLE TUBAR MANCHE ALU 115 24 VIRAX 013624	U	21467.6	221,00



SERRE-TUBE

Clé Viragrip - Mâchoire mobile



DÉSIGNATION	UT	CODE	PPHT (€)
887.0102.24 CLE VIRAGRIP ALLIAGE LEGER 21/2 VIRAX 013745	U	74837.6	113,60



SERRE-TUBE

Clé Viragrip - Renforcée Fonte Heavy Duty



DÉSIGNATION	UT	CODE	PPHT (€)
887.0066.69 CLE VIRAGRIP FONTE 450MM 21/2 VIRAX 013818	U	1305L.6	74,10



SERRE-TUBE

Clé Viragrip - A chaîne - Double denture



DÉSIGNATION	UT	CODE	PPHT (€)
887.0062.10 CLE GRIPPING 4 DOUBLE DENTURE VIRAX 014100	U	21088.0	69,00



SERRE-TUBE

Clé à sangle - Destinée au serrage de pièces dont l'état de surface ne doit pas être marqué



DÉSIGNATION	UT	CODE	PPHT (€)
887.0067.41 CLE A SANGLE DE 1500MM VIRAX 011620	U	74691.7	74,90

OUTILLAGE PLOMBIER

OUTILS DE SERRAGE



SERRE-TUBE

Clé Stillson - Manche et mâchoires en acier spécial traité



	DÉSIGNATION	UT	CODE	PPHT (€)
887.0031.59	CLE STILLSON ACIER 350MM 11/2 VIRAX 012535	U	74695.8	35,10
887.0041.13	CLE STILLSON ACIER 450MM 2 VIRAX 012545	U	74745.1	45,70

OUTILS DE COUPE ET SCIAGE



SCIE A FIL

Pour couper les tuyaux en PVC, PVC-C, PP et PE



	DÉSIGNATION	UT	CODE	PPHT (€)
921.0021.06	SCIE A FIL COUPE TUBE GRIFFON 6307762	U	9495L.9	28,08



COUPE TUBE

Pour tube PER et Multicouche et gaine de protection



	DÉSIGNATION	UT	CODE	PPHT (€)
889.0104.65	COUPE TUBE PER/MC/GAIN.PROT.210MM 90 25 20 SB	U	28916.3	104,65



COUPE TUBE

Pour tubes plastiques et manchons d'étanchéité



	DÉSIGNATION	UT	CODE	PPHT (€)
889.0028.70	COUPE TUBE PLAST.BIX 20-50MM 90 22 10 BK	U	325L1.7	28,70



COUPE TUBE

Pour tube Multicouche et tube plastique - Pour couper selon le principe du cliquet



	DÉSIGNATION	UT	CODE	PPHT (€)
889.0119.90	COUPE TUBE MULTI-COUCHE D26 PLASTIQ 90 25 25	U	A01DR.8	119,90

OUTILLAGE PLOMBIER

OUTILS DE COUPE ET SCIAGE



COUPE TUBE ELECTROPORTATIF

PEX - C12 PPC



	DÉSIGNATION	UT	CODE	PPHT (€)	ECOPART (€)
884.0179.00	COUPE TUBE PEX C12 PPC-D 4933416550	U	275FH.5	179,42	0,42



CISEAUX POUR TUBE

Ciseaux pour tube - ROS



	DÉSIGNATION	UT	CODE	PPHT (€)
000.0083.87	CISAILLE TUBE ROS P 42 PS REMS 291000RPS	U	2681V.9	83,87
000.0057.30	CISAILLE TUBE ROS P 26 REMS 291240R	U	55838.7	57,30
000.0094.46	CISAILLE TUBE ROS P 42 S REMS 291010R	U	170BW.4	94,46
000.0165.04	CISAILLE TUBE ROS P 63 P REMS 291270R	U	8164J.5	165,04



COUPE TUBE MANUEL

Pour tube cuivre - RAS - Avec molette de coupe et ébavureur intégré



	DÉSIGNATION	UT	CODE	PPHT (€)
000.0058.02	COUPE TUBE RAS CU 3-35 1/8-1"3/8 113340 R	U	168J9.6	58,02



COUPE TUBE MANUEL

Pour tube cuivre-inox - RAS - Avec molette de coupe



	DÉSIGNATION	UT	CODE	PPHT (€)
000.0185.80	COUPE TUBE RAS CU-INOX 6-64 REMS 113400R	U	40459.0	185,80
000.0028.55	COUPE TUBE RAS CU-INOX 3-16 1/8-5/8" 113200 R	U	196GJ.9	28,55
000.0039.55	COUPE TUBE RAS CU-INX 3-28 1/8-1"1/8 113240 R	U	17165.1	39,55



MINI COUPE TUBE CUIVRE



	DÉSIGNATION	UT	CODE	PPHT (€)
887.0019.35	MINI COUPE TUBE CUIVRE 3-16MM VIRAX 210437	U	88503.8	21,50

Le PPHT comprend l'ecopart (€)

Les tarifs et disponibilités de nos produits peuvent évoluer sans préavis

RICHARDSON

365

OUTILLAGE PLOMBIER

OUTILS DE COUPE ET SCIAGE



COUPE TUBE PLASTIQUE PC42



	DÉSIGNATION	UT	CODE	PPHT (€)
887.0084.96	COUPE TUBE PLASTIQUE PC 42 42MM VIRAX 215042	U	4547G.7	94,40



COUPE TUBE PLASTIQUE PC50



	DÉSIGNATION	UT	CODE	PPHT (€)
887.0109.80	COUPE TUBE PLASTIQUE PC 50 50MM VIRAX 215050	U	32200.7	109,80



COUPE GAINÉ Coupe gaine 2116 - Annelée Ø 45 mm



	DÉSIGNATION	UT	CODE	PPHT (€)
887.0046.62	COUPE GAINÉ PAS 2.7MM VIRAX 211627	U	1099A.8	51,80



ACCESSOIRES Lame pour coupe tube plastique/mat. composite



	DÉSIGNATION	UT	CODE	PPHT (€)
887.0030.50	LAME P.COUPÉ-TUBE C40/PC42 VIRAX 214041	U	62957.6	30,50

OUTILS DE CINTRAGE



CINTREUSE ARBALETE Coffret - SWING - Pour tube Cuivre et Multicouche - Jusqu'à 90°



	DÉSIGNATION	UT	CODE	PPHT (€)
000.0375.76	CINTREUSE ARBALET.SWING SET 3/8-7/8" 153021 R	U	5507M.1	375,76
000.0359.15	CINTREUSE SWING SET 14-26 REMS 153026R	U	6557F.1	359,15

OUTILLAGE PLOMBIER

OUTILS DE CINTRAGE



ACCESSOIRES DE CINTRAGE Huile - Pour cintreuse hydraulique - Pour Vérin



	DÉSIGNATION	UT	CODE	PPHT (€)
887.0016.92	HUILE P.VÉRIN HYDROLIQUE-BID.1L- VIRAX 240101	U	12278.8	18,80

OUTILS DE FILETAGE



ACCESSOIRE FILIERE Huile de coupe - Minérale



	DÉSIGNATION	UT	CODE	PPHT (€)
887.0012.33	HUILE DE COUPE MIN. -AER.500ML- VIRAX 110200	U	46494.1	13,70

OUTILS D'ÉBAVURAGE ET CALIBRAGE



ÉBAVUREUR REG Universel



	DÉSIGNATION	UT	CODE	PPHT (€)
000.0026.78	ÉBAVUREUR REG.UNIVERSAL REMS 113910R	U	21115.0	26,78



ÉBAVUREUR REG 3-35



	DÉSIGNATION	UT	CODE	PPHT (€)
000.0020.03	ÉBAVUREUR REG 3-35 REMS 113900R	U	44069.3	20,03



ÉBAVUREUR REG 8-35



	DÉSIGNATION	UT	CODE	PPHT (€)
000.0066.95	ÉBAVUREUR REG 8-35 REMS 113825R	U	0869K.8	66,95

OUTILLAGE PLOMBIER

OUTILS D'ÉBAVURAGE ET CALIBRAGE

virax

ÉBAVUREUR

A cliquet



	DÉSIGNATION	UT	CODE	PPHT (€)
887.0162.00	CALIBREUR 40X3,5-50X4-63X4,5MM VIRAX 221280	U	272HO.7	202,50

virax

ÉBAVUREUR

Tonneau



	DÉSIGNATION	UT	CODE	PPHT (€)
887.0028.80	ÉBAVUREUR INTERIEUR/EXTERIEUR VIRAX 221250	U	09802.0	32,00

virax

ÉBAVUREUR

Double fonction - Pour recalibrer et ébavurer -
Tube multicouche



	DÉSIGNATION	UT	CODE	PPHT (€)
887.0061.83	CALIBREUR ÉBAVUREUR 16X2-32X3 VIRAX 221276	U	53916.1	68,70

OUTILS DE SOUDAGE, BRASAGE ET ETANCHEITE

AirLiquide

EQUIPEMENT DE SOUDAGE FLAMME

MINITOP - Poste



	DÉSIGNATION	UT	CODE	PPHT (€)
020.1479.86	POSTE MINITOP EQUIPE A.L. 43072	U	1167A.5	1479,86

AirLiquide

RECHARGE DE GAZ

AZOTE



	DÉSIGNATION	UT	CODE	PPHT (€)
895.0078.37	RECHARGE AZOTE PETITE BOUTEILLE 0.9M3 220	U	22438.6	87,08

AirLiquide

RECHARGE DE GAZ

OXYGENE



	DÉSIGNATION	UT	CODE	PPHT (€)
895.0064.54	RECHARGE OXYGENE OXYFLAM 500 P.BOUT.0.5M3 121	U	07630.7	71,71

OUTILLAGE PLOMBIER

OUTILS DE SOUDAGE, BRASAGE ET ETANCHEITE

AirLiquide

RECHARGE DE GAZ

OXYGENE

- suite



	DÉSIGNATION	UT	CODE	PPHT (€)
895.0078.37	RECHARGE OXYGENE OXYFLAM 1000 P.BOUT.1M3 120	U	22334.7	87,08
895.0078.37	RECHARGE OXYGENE MINITOP P.BOUT.1M3 122	U	53742.3	87,08
895.0086.17	RECHARGE OXYGENE ROLLERFLAM P.BOUT.2.3M3 115	U	83574.4	95,75

AirLiquide

RECHARGE DE GAZ

ACÉTYLÈNE



	DÉSIGNATION	UT	CODE	PPHT (€)
895.0064.54	RECHARGE ACÉTYLENE OXYF.500 P.BOUT.0.42M3 321	U	07633.1	71,71
895.0078.37	RECHARGE ACÉTYLENE OXYF.1000 P.BOUT.0.8M3 320	U	22370.1	87,08
895.0086.17	RECHARGE ACÉTYLENE ROLLERF.P.BOUT. 1.4M3 315	U	83575.1	95,75
895.0078.37	RECHARGE ACÉTYLENE.MINITOP P.BOUT. 0.8M3 322	U	53745.6	87,08

**ASPEN
PUMPS**

CHALUMEAU



	DÉSIGNATION	UT	CODE	PPHT (€)
000.0077.00	CHALUMEAU FLEXI TORCH JAV-1004	U	355XA.8	102,66

**Castolin
PRO**

CHALUMEAU SOUDEUR

AutoFlam II



	DÉSIGNATION	UT	CODE	PPHT (€)
883.0144.22	CHALUMEAU AUTOFLAM II SI 0 55200S 1 764523	U	1670H.9	192,29

**Castolin
PRO**

CHALUMEAU SOUDEUR

CTK 27 - Kit



	DÉSIGNATION	UT	CODE	PPHT (€)
020.0137.34	CHALUMEAU CTK27 -KIT VAL+1BOUT-45153BC 757779	U	69965.2	137,34

OUTILLAGE PLOMBIER

OUTILS DE SOUDAGE, BRASAGE ET ETANCHEITE

Castolin PRO CHALUMEAU SOUDEUR CTK 27 - Kit valise



	DÉSIGNATION	UT	CODE	PPHT (€)
020.0251.88	CHALUMEAU CTK27 -KIT VAL+2BOU+45153KV 757780	U	69962.9	251,88

Castolin PRO POSTE DE SOUDAGE CastoFlam - SI

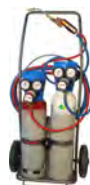

	DÉSIGNATION	UT	CODE	PPHT (€)
020.0869.32	POSTE SOUDAGE CASTOFLAM SI 79154 SI 760342	U	6961C.8	1159,10

Castolin PRO ACCESSOIRE SOUDAGE Cartouche de gaz



	DÉSIGNATION	UT	CODE	PPHT (€)
882.0039.28	CARTOUCHE OXYGENE 930ML 7302400X 600826	U	14735.5	52,37
882.0032.15	CARTOUCHE GAZ GASPRO 1L 453006P 757038	U	9522L.6	32,15
882.0013.31	CARTOUCHE GAZ CHAL.1450-380ML-730240GM 600069	U	81776.7	17,75

Castolin PRO ACCESSOIRE SOUDAGE Collier de serrage



	DÉSIGNATION	UT	CODE	PPHT (€)
883.0015.35	COLLIER TUYAU 10X17 -15- 730038AX15 662927	U	171VY.4	20,47

Castolin PRO ACCESSOIRE SOUDAGE Alliage de soudobrasage et de brasage - 18 XFC



	DÉSIGNATION	UT	CODE	PPHT (€)
882.0213.79	SOUDO BRASURE 1KG -BAG.3.0- 18XFC3010P 650064	U	52654.1	213,79

Castolin PRO ACCESSOIRE SOUDAGE Alliage de brasage Cupro-phosphore - 800



	DÉSIGNATION	UT	CODE	PPHT (€)
882.0123.55	BRASURE CUIVRE 500G-BAG.2.0- 8002005F 651097	U	9769A.0	123,55

OUTILLAGE PLOMBIER

OUTILS DE SOUDAGE, BRASAGE ET ETANCHEITE

Castolin PRO ACCESSOIRE SOUDAGE

Alliage de brasage Cupro-phosphore - 804



	DÉSIGNATION	UT	CODE	PPHT (€)
882.0175.95	BRASURE CUIVRE 1KG -BAG.2.0- 8042010P 651127	U	78177.3	234,60

Castolin PRO ACCESSOIRE SOUDAGE

Alliage de brasage Cupro-phosphore - RB 5246



	DÉSIGNATION	UT	CODE	PPHT (€)
882.0044.92	BRASURE CUIVRE 1KG-BAG.2.0-5246RB2010P 600784	U	66391.4	52,85

Castolin PRO ACCESSOIRE SOUDAGE

Alliage de brasage Cupro-phosphore - RB 5281



	DÉSIGNATION	UT	CODE	PPHT (€)
882.0038.36	BRASURE CUIVRE 1KG-BAG.2.0-5281RB2010P 652758	U	83267.5	51,15

Castolin PRO ACCESSOIRE SOUDAGE

Alliage de brasage capillaire à l'argent - 1665 GAZ



	DÉSIGNATION	UT	CODE	PPHT (€)
882.0270.57	BRASURE ARG.100G -BAG.2.0-1665GAZ2001P 753716	U	83535.5	270,57

Castolin PRO ACCESSOIRE SOUDAGE

Alliage pour brasage tendre - 157 GAZ



	DÉSIGNATION	UT	CODE	PPHT (€)
882.0091.59	SOUDO BRASURE 250G-FIL 2.0-157GAZ2002P 754976	U	01443.1	91,59

Castolin PRO ACCESSOIRE SOUDAGE

Alliage pour brasage tendre - BN 5423



	DÉSIGNATION	UT	CODE	PPHT (€)
882.0038.90	SOUDO BRASURE 250G-FIL 2.0-5423BN2002P 600864	U	90481.3	51,86

OUTILLAGE PLOMBIER

OUTILS DE SOUDAGE, BRASAGE ET ETANCHEITE

Castolin PRO

ACCESSOIRE SOUDAGE

Décapant - Pour soudure étain



	DÉSIGNATION	UT	CODE	PPHT (€)
882.0038.36	DECAPANT FX4299 BOITE 200G 4299FX0200P 600803	U	69327.5	51,14
882.0050.04	DECAPANT FX157 BOITE 200G 157FX0200P 755521	U	4380P.2	50,04

Castolin PRO

ACCESSOIRE SOUDAGE

Décapant - Pour brasure cupro-phosphore



	DÉSIGNATION	UT	CODE	PPHT (€)
882.0038.36	DECAPANT POUVRE -BOITE 200G- 8000200P 651089	U	56566.3	51,14
882.0038.36	DECAPANT PATE BL.-BTE200G- 808PF0200P 651170	U	13924.6	51,14

Castolin PRO

ACCESSOIRE SOUDAGE

Décapant - Sans cadmium



	DÉSIGNATION	UT	CODE	PPHT (€)
882.0038.36	DECAPANT 1665PF BOITE 200G 1665PF0200P 753749	U	48506.0	51,14

Castolin PRO

ACCESSOIRE SOUDAGE

Ecran thermique



	DÉSIGNATION	UT	CODE	PPHT (€)
883.0086.16	ECRAN PRO THERM.DBL.FACE-01- 730373DF 657682	U	4552B.0	86,16

Castolin PRO

ACCESSOIRE SOUDAGE

Etoile pour Chalumeau soudeur



	DÉSIGNATION	UT	CODE	PPHT (€)
883.0022.52	ETOILE 6 BECS STD TYPE 0 AD 704289STD 662903	U	45821.6	30,03

Castolin PRO

MANO-DETENDEUR

Oxygène - Typhoon



	DÉSIGNATION	UT	CODE	PPHT (€)
883.0079.67	DETENDEUR TYPHOON OXYGENE 77021200 758044	U	0308X.2	79,67

OUTILLAGE PLOMBIER

OUTILS DE SOUDAGE, BRASAGE ET ETANCHEITE

Castolin PRO

MANO-DETENDEUR

Acétylène - Typhoon



	DÉSIGNATION	UT	CODE	PPHT (€)
883.0079.67	DETENDEUR TYPHOON ACETYLENE 77021199 758043	U	0308W.4	79,67

GEB
La référence des plombiers, depuis 1860

PRODUIT DE BRASAGE/SOUDAGE

HAMPTON HP3 - Gel décapant pour soudure à l'étain - Pâte



	DÉSIGNATION	UT	CODE	PPHT (€)
921.0015.41	DECAPANT PATE HAMPTON HP3 -POT 150ML- 100303	U	63966.6	18,13

GEB
La référence des plombiers, depuis 1860

PRODUIT DE BRASAGE/SOUDAGE

HAMPTON HP3 - Gel décapant pour soudure à l'étain - Gel



	DÉSIGNATION	UT	CODE	PPHT (€)
921.0012.63	DECAPANT PATE HAMPTON HP3 -POT 75ML- 100302	U	63964.1	14,86

GEB
La référence des plombiers, depuis 1860

PRODUIT DE BRASAGE/SOUDAGE

GEBSOFLUX - Flux décapant liquide pour soudure à l'étain



	DÉSIGNATION	UT	CODE	PPHT (€)
921.0014.19	FLUX DECAPANT GEBSOFLUX -FLAC.80ML- 105290	U	66252.8	16,69

GEB
La référence des plombiers, depuis 1860

PRODUIT DE BRASAGE/SOUDAGE

Sel ammoniac pour le nettoyage des pannes de fer à souder - Chlorure d'ammonium



	DÉSIGNATION	UT	CODE	PPHT (€)
921.0008.42	SEL AMMONIAC -PAIN 140G- 815998	U	317NT.6	9,91

OUTILLAGE PLOMBIER

OUTILS DE SOUDAGE, BRASAGE ET ETANCHEITE



PRODUIT DE BRASAGE/SOUDAGE
STEARINE - Pain de lissage des soudures



	DÉSIGNATION	UT	CODE	PPHT (€)
921.0012.03	STEARINE -PAIN 250G- 819893	U	8190W.8	20,05



OUTILS DE BRASAGE/SOUDAGE
STEAROX - Lissage des soudures étain/cuivre



	DÉSIGNATION	UT	CODE	PPHT (€)
921.0010.62	PORTE SOUDURE STEAROX 516099	U	42420.0	12,49



ACCESSOIRES DE BRASAGE ET SOUDURE

Miroir - Soudeur magnétique



	DÉSIGNATION	UT	CODE	PPHT (€)
880.0041.53	MIROIR A SOUDER MAGNETIQUE KS 903.6000	U	25492.0	48,86



PRODUIT ETANCHEITE

Filetfix III - Pour raccord fileté - Polymérisation rapide



	DÉSIGNATION	UT	CODE	PPHT (€)
887.0034.90	RESINE ETANCHEITE FILETFIX III VIRAX 262600	U	76247.6	34,90

OUTILS DE MAINTENANCE ET REPARATION



POMPE D'EPREUVE
Manuelle



	DÉSIGNATION	UT	CODE	PPHT (€)
000.0278.18	POMPE D'EPREUVE MANU.PUSH REMS 115000 R	U	168JD.7	278,18

OUTILLAGE PLOMBIER

OUTILS DE MAINTENANCE ET REPARATION



DEBOUCHEUR MANUEL

A Pression - A pompe



	DÉSIGNATION	UT	CODE	PPHT (€)
887.0134.91	DEBOUCHEUR A POMPE 2 EMBOUTS VIRAX 290210	U	46690.4	149,90



DEBOUCHEUR MANUEL

A câble - A tambour - Avec paire de gants



	DÉSIGNATION	UT	CODE	PPHT (€)
887.0062.55	DEBOUCHEUR MANUEL DEB.PROPRE VIRAX 290600	U	53753.0	69,50

Pour plus d'infos,
consultez
le CAHIER TECHNIQUE
page 14

J+0 100% DISPO



**L'atout
LIBRE-SERVICE**

- Un large choix de produits
- Tous les produits de ce catalogue à votre disposition
- Une équipe à votre service

OUTILLAGE CARRELEUR

OUTILS DE MALAXAGE

LITOKOL
HI PERFORMANCE BUILDING PRODUCTS

ACCESSOIRE DE MALAXAGE

Tige



	DÉSIGNATION	UT	CODE	PPHT (€)
999.0000.00	TIGE MALAXEUR POUR STARLIKE 133T0001	U	164H7.1	NC

OUTILS DE POSE

LITOKOL
HI PERFORMANCE BUILDING PRODUCTS

TALOCHÉ

A colle - Denture carrée



	DÉSIGNATION	UT	CODE	PPHT (€)
025.0011.91	TALOCHÉ A COLLE DENTURE CARREE 6MM 906	U	169WY.7	15,88
025.0011.91	TALOCHÉ A COLLE DENTURE CARREE 10 MM 909	U	164GN.9	15,88

LITOKOL
HI PERFORMANCE BUILDING PRODUCTS

TALOCHÉ

A colle - Denture en U



	DÉSIGNATION	UT	CODE	PPHT (€)
025.0012.77	TALOCHÉ A COLLE 1/2 LUNE 20X10MM 902	U	164GP.7	17,03

LITOKOL
HI PERFORMANCE BUILDING PRODUCTS

TALOCHÉ

Tiger



	DÉSIGNATION	UT	CODE	PPHT (€)
025.0012.98	TALOCHÉ TIGER TROWEL 911TG	U	5404P.1	17,30

LITOKOL
HI PERFORMANCE BUILDING PRODUCTS

TALOCHÉ

Verte rigide pour joints époxydes



	DÉSIGNATION	UT	CODE	PPHT (€)
025.0009.55	TALOCHÉ VERTE POUR EPOXY 946GR	U	163LQ.2	12,73

PAVILIFT PINCE DE SERRAGE

Pour croisillon



	DÉSIGNATION	UT	CODE	PPHT (€)
000.0015.60	PINCE DE SERRAGE CROISILLON SACPCLAS	U	298LT.0	19,50

OUTILLAGE CARRELEUR

ACCESSOIRES DE POSE

PAVILIFT BAGUE DE PROTECTION

Clipsable



	DÉSIGNATION	UT	CODE	PPHT (€)
000.0017.60	BAGUE DE PROTECT/CLIPSA.SACHET 30 BAGCLIP30NB	U	301VW.1	17,60

PAVILIFT CADRAN DE SERRAGE

Noir - 3 - 12 mm



	DÉSIGNATION	UT	CODE	PPHT (€)
000.0045.60	CADRAN SERRAGE NOIR 3-12MM -BTE70- CAD70N	U	9233Q.8	57,00

PAVILIFT CALE POUR SYSTEME AUTONIVELLANT

Noir - 3 - 12 mm



	DÉSIGNATION	UT	CODE	PPHT (€)
000.0016.80	CALE DE SERRAGE AUTONIV. CART. 125 SACCALC125	U	302CZ.7	21,00

PAVILIFT CROISILLON

1" Autonivelant à cales



	DÉSIGNATION	UT	CODE	PPHT (€)
000.0022.04	CROISILLON AUTONIV.CALE 2MM/I C/250 SAC2IC250	U	302DA.4	27,55
000.0022.04	CROISILLON AUTONIV.CALE 3MM/I C/250 SAC3IC250	U	302DC.0	27,55
000.0067.84	CROISILLON NIVELLEMENT 2MM -1000- SAC2IC1000	U	298LM.2	84,80

PAVILIFT CROISILLON

1" Autonivelant à vis - Tous types de poses - Epaisseur 3 à 18 mm



	DÉSIGNATION	UT	CODE	PPHT (€)
000.0027.80	CROISILLON 1.5MM BLANC EN I -S250- SCR217SB	U	199KN.1	34,75
000.0026.97	CROISILLON 2MM JAUNE EN I -S.250- SCR220SJ	U	199KP.9	33,71
000.0027.66	CROISILLON 3MM BLEU EN I -S250- SCR230SB	U	203SE.6	34,58
000.0092.73	CROISILLON 2MM JAUNE EN I -SEAU1000- CR1020SJ	U	222UM.9	115,91

PAVILIFT CROISILLON

Y" de carreleur



	DÉSIGNATION	UT	CODE	PPHT (€)
000.0003.36	CROISILLON CARREL.2MM/Y120 SCH250 CC2Y120S250	U	339HN.6	4,20

OUTILLAGE CARRELEUR

ACCESSOIRES DE POSE



PLATINE DE PROTECTION

Antiabrasion - 3 - 12 mm



	DÉSIGNATION	UT	CODE	PPHT (€)
000.0024.80	PLATINE PROTECT/ANTIABRAS. -500- SACPLATC500	U	302D0.6	31,00

ACCESSOIRES DE NETTOYAGE



HI PERFORMANCE GRADING PRODUCTS

BAC DE LAVAGE

Kit



	DÉSIGNATION	UT	CODE	PPHT (€)
025.0061.61	KIT BAC A LAVAGE POUR JOINT 993	U	164H5.5	82,15



HI PERFORMANCE GRADING PRODUCTS

EPONGE

Sweepex



	DÉSIGNATION	UT	CODE	PPHT (€)
025.0002.78	EPONGE SWEEPEX POUR CIMENT 128G0001	U	163LP.4	3,70
025.0010.84	EPONGE SWEEPEX POUR EPOXY 131G0001	U	164GT.9	14,45

OUTILLAGE FRIGORISTE

OUTILS DE RACCORDEMENT



ACCESSOIRES

Joint pour flexible



	DÉSIGNATION	UT	CODE	PPHT (€)
000.0010.31	JOINT P.FLEX.JAV-1072 1/4-5/16-10- JAV-1276	U	347VA.7	10,31



CINTRAGE

Cintreuse 4 tuyaux - 4 rouleaux de 4 m



	DÉSIGNATION	UT	CODE	PPHT (€)
000.0034.16	CINTREUSE 4 TUYAUX B3500	U	A000V.5	45,54



CONNECTEUR ADAPTATEUR

FLEXI



	DÉSIGNATION	UT	CODE	PPHT (€)
000.0001.82	CONNECTEUR ADAPT.FLEXI 25MM VERT B3393	U	A0013.1	2,43
000.0001.92	CONNECTEUR ADAPT.FLEXI 32MM BLANC B3394	U	A0012.3	2,56



CLES DYNAMOMETRIQUES

KIT DE CLES



	DÉSIGNATION	UT	CODE	PPHT (€)
000.0101.39	CLE DYNAMOMETR.10-75NM 17/29MM-KIT 7- JAV-TW8	U	324K9.4	135,19



CONNECTEUR DROIT

PVC rigide



	DÉSIGNATION	UT	CODE	PPHT (€)
000.0001.26	CONNEXION DROITE+JOINT 20MM O RING B3301	U	A0010.7	1,58

OUTILLAGE FRIGORISTE

OUTILS DE RACCORDEMENT



DUDGEONNIERE EXCENTRIQUE

Dudgeonniere excentrique



	DÉSIGNATION	UT	CODE	PPHT (€)
000.0137.02	DUDGEONNIERE EXCENTRIQUE 3/16-3/4" JAV-1024	U	293W3.8	182,70



TUYAU D'EVACUATION

PVC rigide



	DÉSIGNATION	UT	CODE	PPHT (€)
000.0001.93	TUYAU D'EVACUATION PVC RIGIDE 20MM B3300	U	A00TC.8	1,93



DUDGEONNIERE

Coffret matrice et étrier - Pour tube recuit - Pour collet conique à 45°



	DÉSIGNATION	UT	CODE	PPHT (€)
887.0115.65	DUDGEONNIERE PROF.3/16-3/4 VIRAX 250580	U	6175A.4	128,50

CHARGE/DECHARGE DE GAZ



POMPE A VIDE

Anti-éteincelles



	DÉSIGNATION	UT	CODE	PPHT (€)
000.0354.15	POMPE A VIDE ANT-ETIN.AZL 151L/M JAV-1065-AZL	U	355XR.6	472,20



POMPE A VIDE

Huile de pompe a vide universelle



	DÉSIGNATION	UT	CODE	PPHT (€)
000.0011.13	HUILE POMPE A VIDE UNIVERS.1L JAVAC HV68/1J	U	386UY.9	14,84

OUTILLAGE FRIGORISTE

CHARGE/DECHARGE DE GAZ



STATION DE RECUPERATION

XTR-Ultra A2L



	DÉSIGNATION	UT	CODE	PPHT (€)
000.0707.38	STATION RECUP.XTR-ULTRA A2L JAV-1063-A2L	U	355XM.4	943,18



GAZ

Charge azote B10



	DÉSIGNATION	UT	CODE	PPHT (€)
000.0068.60	CHARGE GAZ AZOTE B10 400310	U	335UY.6	68,60



GAZ

Charge R32



	DÉSIGNATION	UT	CODE	PPHT (€)
000.0295.80	CHARGE GAZ R32-9KG/12L 505110	U	295R3.8	295,80



GAZ

Charge R32 - Cartouche



	DÉSIGNATION	UT	CODE	PPHT (€)
000.0029.29	CHARGE GAZ R32-780G TR32/1FE	U	324DR.6	29,29



GAZ

Charge R134A



	DÉSIGNATION	UT	CODE	PPHT (€)
000.0608.75	CHARGE GAZ R134A-12KG/12L 541101	U	295R8.7	608,75



GAZ

Charge R290 - Cartouche



	DÉSIGNATION	UT	CODE	PPHT (€)
000.0020.72	CHARGE GAZ R290-370G TR290/1FE	U	324D0.8	20,72

OUTILLAGE FRIGORISTE

CHARGE/DECHARGE DE GAZ



GAZ
Charge R407C



	DÉSIGNATION	UT	CODE	PPHT (€)
000.0730.93	CHARGE GAZ R407C-11KG/12L 549101	U	295RA.2	730,93

OUTILS DE MESURE ET CONTROLE



BALANCE ELECTRONIQUE
Procharge 100kg



	DÉSIGNATION	UT	CODE	PPHT (€)
000.0240.73	BALANCE ELECTRONIQUE PROCHARGE 100KG G58610	U	336QE.6	320,97



MANIFOLD
R410A/R32



	DÉSIGNATION	UT	CODE	PPHT (€)
000.0143.69	MANIFOLD SEULS 4 VOIES R410A/R32 -JAV-EL75700	U	367ZP.3	191,59



MANIFOLDS BYPASS ET ACCESSOIRES
Flexible de charge



	DÉSIGNATION	UT	CODE	PPHT (€)
000.0102.78	FLEXIBLE CHARGE R410A/R32 1/4"-5/16" JAV-1072	U	279ZS.4	137,04



VACUOMETRE
Vacuomètre électronique



	DÉSIGNATION	UT	CODE	PPHT (€)
000.0238.90	VACUOMETRE ELECTRONIQUE JAV-1041	U	355LO.6	318,54

OUTILLAGE FRIGORISTE

OUTILS DE MESURE ET CONTROLE



DETECTEUR
316



	DÉSIGNATION	UT	CODE	PPHT (€)
880.0499.00	DETECTEUR FUITE FLUID.FR.316-4 SET1 0563 3164	U	10887.8	499,00



ANALYSEUR DE FROID
Manifold électronique 2 voies - 550S avec sonde filaire à pince



	DÉSIGNATION	UT	CODE	PPHT (€)
000.0449.00	ANALYSEUR FROID ELECT.550S BT TESTO 0564 5501	U	300A2.9	449,00



ANALYSEUR DE FROID
Manifold électronique 4 voies - 557S



	DÉSIGNATION	UT	CODE	PPHT (€)
000.0670.00	ANALYSEUR FROID ELECT.557S BT TESTO 0564 5571	U	300A8.6	670,00



VACUOMETRE
Vacuomètre électronique - 552



	DÉSIGNATION	UT	CODE	PPHT (€)
000.0220.00	VACUOMETRE ELECTRONIQUE 552 BT 0560 5522	U	1669U.9	220,00



SONDE CONNECTEE
Sonde connectée



	DÉSIGNATION	UT	CODE	PPHT (€)
880.0117.00	ANEMOMETRE A HELICE 410I TESTO 0560 1410	U	8784Q.3	117,00

OUTILLAGE UNIVERSEL

OUTILS A MAIN



COUPE TUBE



	DÉSIGNATION	UT	CODE	PPHT (€)
000.0029.28	COUPE TUBE 1/8-1"1/4 LAME TITANE JAV-1012	U	355XJ.0	39,04



MINI COUPE TUBE



	DÉSIGNATION	UT	CODE	PPHT (€)
000.0015.74	COUPE-TUBE MINI 1/8"-1"1/4 JAV-1010	U	384VS.6	20,98



COUPE

Coupe gaine



	DÉSIGNATION	UT	CODE	PPHT (€)
889.0037.85	COUPE GAINÉ CIRCULICTA TWISTCUT 90 22 02 SB	U	182GS.3	37,85



COUPE

Pince coupante - De côté



	DÉSIGNATION	UT	CODE	PPHT (€)
889.0027.55	PINCE COUPANTE DE CÔTE BL/BLC/RG 7002160S7	U	A0BD4.2	27,55



COUPE

Pince coupante - A forte démultiplication



	DÉSIGNATION	UT	CODE	PPHT (€)
889.0032.80	PINCE COUPANTE DE CÔTE 180MM 74 02 180	U	1187A.1	32,80
889.0037.00	PINCE COUPANTE DE CÔTE 180MM 74 12 180	U	40736.1	37,00

OUTILLAGE UNIVERSEL

OUTILS A MAIN



COUPE

Tenaille russe - Gainée - Plastique



	DÉSIGNATION	UT	CODE	PPHT (€)
889.0016.90	TENAILLE RUSSE GAINÉE PVC 220MM 99 01 220	U	1226A.4	16,90



SERRAGE

Pince à bec demi-rond avec tranchant - Coudé



	DÉSIGNATION	UT	CODE	PPHT (€)
889.0032.50	PINCE COUPANTE BEC 1/2 ROND COUDEE 26 22 200	U	1181A.7	32,50



SERRAGE

Pince-clé



	DÉSIGNATION	UT	CODE	PPHT (€)
889.0058.95	PINCE CLE GAIN.PLAST.180MM CHROME 86 03 180	U	1172A.8	58,95
889.0067.50	PINCE CLE GAIN.PLAST.250MM CHROME 86 03 250	U	1175A.5	67,50
889.0083.95	PINCE A CLE 300MM CHROME 86 03 300	U	1178A.2	83,95



SERRAGE

Clé universelle - TwinKey



	DÉSIGNATION	UT	CODE	PPHT (€)
889.0034.25	CLE UNIV.FERM.TWINKEY POUR ARM. 92MM 00 11 01	U	6302B.8	34,25



SERRAGE

Set outillage - Jeu de pinces



	DÉSIGNATION	UT	CODE	PPHT (€)
889.0104.75	PINCE COBRA 180/250/300 -JEU 3- 00 20 09 V02	U	8233D.4	104,75

OUTILLAGE UNIVERSEL

OUTILS A MAIN



VISSAGE

Ultimate porte-embouts - Tom Pouce



	DÉSIGNATION	UT	CODE	PPHT (€)
880.0007.14	TOURNEVIS PORTE-EMBOUTS 10MM 1/4 KS 922.1197	U	256XZ.0	8,40



VISSAGE

Jeu de tournevis - Ultimate - Ultimate Fente



	DÉSIGNATION	UT	CODE	PPHT (€)
880.0028.22	TOURNEVIS ULTIM.FENTE PH -JEU 6- KS 922.6020	U	7957T.0	33,20



VISSAGE

Jeu de tournevis - Ultimate Isolés



	DÉSIGNATION	UT	CODE	PPHT (€)
880.0047.83	TOURNEVIS ULTIMATE ISO.1000V -8- KS 922.6218	U	7406W.0	56,27



SERRAGE

Clé à cliquet - Gear Plus



	DÉSIGNATION	UT	CODE	PPHT (€)
880.0025.45	CLE POLY.G.CLIIQUET GEARPLUS 10X13 KS 503.4565	U	218GY.2	29,94



SERRAGE

Clé mixte - Ultimate



	DÉSIGNATION	UT	CODE	PPHT (€)
880.0004.00	CLE MIXTE 8 MM KS 922.0008	U	47748.9	4,70
880.0004.14	CLE MIXTE 10 MM KS 922.0010	U	8402T.9	4,87
880.0004.90	CLE MIXTE 13 MM KS 922.0013	U	7406V.2	5,77
880.0006.02	CLE MIXTE 16 MM KS 922.0016	U	4945T.2	7,08
880.0006.88	CLE MIXTE 17 MM KS 922.0017	U	4951W.6	8,10
880.0007.74	CLE MIXTE 19 MM KS 922.0019	U	8402V.4	9,10



SERRAGE

Clé mixte à cliquet réversible - Gear plus



	DÉSIGNATION	UT	CODE	PPHT (€)
880.0015.88	CLE MIXTE CLIQUET REVERS.GEARPLUS 7 503.4607	U	180W2.9	18,68

OUTILLAGE UNIVERSEL

OUTILS A MAIN



SERRAGE

Clé mixte à cliquet réversible - Gear plus
- suite



	DÉSIGNATION	UT	CODE	PPHT (€)
880.0015.88	CLE MIXTE CLIQUET REVERS.GEARPLUS 8 503.4608	U	211JA.1	18,68
880.0016.47	CLE MIXTE CLIQUET REVERS.GEARPLUS 9 503.4609	U	211JB.9	19,38
880.0016.94	CLE MIXTE CLIQUET REVERS.GEARPLUS 10 503.4610	U	211JC.7	19,93
880.0017.37	CLE MIXTE CLIQUET REVERS.GEARPLUS 11 503.4611	U	211K2.8	20,44
880.0018.08	CLE MIXTE CLIQUET REVERS.GEARPLUS 12 503.4612	U	211K4.4	21,27
880.0018.38	CLE MIXTE CLIQUET REVERS.GEARPLUS 13 503.4613	U	30610.8	21,62
880.0020.90	CLE MIXTE CLIQUET REVERS.GEARPLUS 14 503.4614	U	212H1.1	24,59
880.0021.05	CLE MIXTE CLIQUET REVERS.GEARPLUS 15 503.4615	U	180W4.5	24,76
880.0023.09	CLE MIXTE CLIQUET REVERS.GEARPLUS 16 503.4616	U	212H2.9	27,16
880.0023.55	CLE MIXTE CLIQUET REVERS.GEARPLUS 17 503.4617	U	201VY.9	27,71
880.0024.72	CLE MIXTE CLIQUET REVERS.GEARPLUS 18 503.4618	U	212H3.7	29,08
880.0026.32	CLE MIXTE CLIQUET REVERS.GEARPLUS 19 503.4619	U	201VZ.8	30,96
880.0039.69	CLE MIXTE CLIQUET REVERS.GEARPLUS 24 503.4624	U	3061P.0	46,69



SERRAGE

Clé polygonale droite à cliquet - Gear plus



	DÉSIGNATION	UT	CODE	PPHT (€)
880.0022.09	CLE POLY.G.CLIIQUET GEARPLUS 10X13 KS 503.4512	U	211J4.5	25,99



SERRAGE

Clé à pipe débouchée - 6 pans x 6 pans



	DÉSIGNATION	UT	CODE	PPHT (€)
880.0006.53	CLE A PIPE DEBOUCHEE 8MM KS 517.0408	U	24569.6	7,68
880.0007.23	CLE A PIPE DEBOUCHEE 10MM KS 517.0410	U	24616.5	8,51
880.0008.36	CLE A PIPE DEBOUCHEE 13MM KS 517.0413	U	24666.0	9,83



SERRAGE

Jeu de clés - A pipe débouchées 6 pans x 6 pans



	DÉSIGNATION	UT	CODE	PPHT (€)
880.0100.07	CLE A PIPE DEBOUCHEE METR.6P -8- KS 517.0452	U	4216P.2	117,73

OUTILLAGE UNIVERSEL

OUTILS A MAIN



SERRAGE

Clé à molette - Chrome Mat - Standard



	DÉSIGNATION	UT	CODE	PPHT (€)
880.0019.95	CLÉ A MOLETTE L.250MM-10 KS 577.0250	U	40067.1	23,47



SERRAGE

Coffret douilles - ULTIMATE 1/4" - 1/2"



	DÉSIGNATION	UT	CODE	PPHT (€)
880.0130.33	DOUILLE +ACC.ULTIM.1/2 - COFFR.24-KS 922.0623	U	7867P.7	153,33



SERRAGE

Coffret douilles - ULTIMATE 1/4"



	DÉSIGNATION	UT	CODE	PPHT (€)
880.0112.20	DOUILLE +ACC.ULTIM.1/4 - COFFR.44-KS 922.0644	U	7867C.1	132,00



SERRAGE

Jeu de clés mâles - 6 pans - Pour tête abimée



	DÉSIGNATION	UT	CODE	PPHT (€)
880.0036.61	CLÉ MALE TORSIONPOWER 6 PANS -9- KS 151.2800	U	256U6.0	43,07



SERRAGE

Jeu de clés mâles - 6 pans creux - Coudées, tête sphérique



	DÉSIGNATION	UT	CODE	PPHT (€)
880.0018.25	CLÉ MALE COUDEE 6P.CREUX/T.SP -10- KS 151.5000	U	331DU.4	21,47



SERRAGE

Jeu de clés mâles - TORX - Longue - Coudée



	DÉSIGNATION	UT	CODE	PPHT (€)
880.0018.25	CLÉ MALE COUDEE TORX LONGUES -10- KS 151.4880	U	331HN.3	21,47

OUTILLAGE UNIVERSEL

OUTILS A MAIN



COUPE

Cisaille à tôle



	DÉSIGNATION	UT	CODE	PPHT (€)
880.0022.77	CISAILLE UNIVERSELLE GAINEE KS 118.0051	U	74388.0	26,79



COUPE

Couteau pliable - Avec pochette



	DÉSIGNATION	UT	CODE	PPHT (€)
880.0048.94	COUTEAU ACIER ED.LIMITEE+ ETUI KS 907.2121-A1	U	33601.2	57,58



COUPE

Couteau de sécurité - Avec pochette



	DÉSIGNATION	UT	CODE	PPHT (€)
880.0028.56	COUTEAU DE SECURITE 210MM KS 907.2118	U	261WC.5	33,60



LIMAGE

Lime demi-ronde emmanchée - Demi-douce



	DÉSIGNATION	UT	CODE	PPHT (€)
880.0011.06	LIME DEMI-ROUNDE DEMI-DOUCE 200MM KS 157.0105	U	3517K.8	13,01



LIMAGE

Grattoir à lame rétractable



	DÉSIGNATION	UT	CODE	PPHT (€)
999.0007.00	GRATTOIR LAME RETRACTABLE KS 907.2242	U	3665J.0	7,00



SCIE

Pour le PVC



	DÉSIGNATION	UT	CODE	PPHT (€)
880.0022.00	MONTURE DE SCIE PVC 12 300MM KS 907.1105	U	2063C.4	25,88

OUTILLAGE UNIVERSEL

OUTILS A MAIN



SCIE

Lame de scie à main - Bimétal



	DÉSIGNATION	UT	CODE	PPHT (€)
000.0017.79	LAME DE SCIE 12 DENTS 10PCS 129.6620/12	U	20287.9	20,93



SCIE

Monture de scie - Bi-matière



	DÉSIGNATION	UT	CODE	PPHT (€)
880.0039.89	MONTURE DE SCIE BI-MATIERE 45/90 KS 907.2112	U	30534.2	46,93

STANLEY

COUPE

Cutter - A cartouche - FatMax Xtrem



	DÉSIGNATION	UT	CODE	PPHT (€)
955.0020.12	CUTTER FATMAX.XL A CART.25MM STANLEY 0-10-820	U	0770K.6	25,15

STANLEY

COUPE

Lame de cutter - Classique



	DÉSIGNATION	UT	CODE	PPHT (€)
955.0011.80	LAME DE CUTTER 25MM STANLEY 0-11-325	U	4168B.6	14,75



SERRAGE

Clé à cliquet - A tête flexible



	DÉSIGNATION	UT	CODE	PPHT (€)
887.0134.60	CLE A CLIQUET TETE FLEX.8-17MM-7-VIRAX 310325	U	4547H.5	134,60



SERRAGE

Clé à molette - A ouverture extra large



	DÉSIGNATION	UT	CODE	PPHT (€)
887.0036.36	CLE A MOLETTE GDE OUVERTURE 6 VIRAX 017045	U	1515C.0	40,40
887.0028.40	CLE A MOLETTE MORS EXTRA FINS 6 VIRAX 017047	U	7528L.4	45,80
887.0043.29	CLE A MOLETTE GDE OUVERTURE 8 VIRAX 017050	U	0383D.9	48,10
887.0053.60	CLE A MOLETTE MORS EXTRA FINS 8 VIRAX 017052	U	7528M.2	53,60

OUTILLAGE UNIVERSEL

RANGEMENT POUR OUTILS



BOITE A OUTILS

Caisse métallique



	DÉSIGNATION	UT	CODE	PPHT (€)	ECOPART (€)
880.0061.20	CAISSE A OUTILS METALLIQ. 5 COMPART. 999.0125	U	61422.2	72,18	0,18



BOITE A OUTILS

SCM



	DÉSIGNATION	UT	CODE	PPHT (€)	ECOPART (€)
880.0040.23	CAISSE A OUTILS SCM 450X260X240MM KS 850.0382	U	238RW.9	47,71	0,38



PORTE-OUTILS

Sac à bandoulière



	DÉSIGNATION	UT	CODE	PPHT (€)
880.0089.65	SAC A BANDOULIERE SMARTBAG XL KS 850.0325	U	1593A.9	105,47

STANLEY

ORGANISEUR

FatMax étanche



	DÉSIGNATION	UT	CODE	PPHT (€)
955.0028.87	BOITE ETANCHE FATMAX BASSE STANLEY 1-97-517	U	74870.7	36,09
955.0033.22	ORGANISEUR ETANCH.FATMAX 106 STANLEY 1-97-518	U	74873.1	41,53

STANLEY

ORGANISEUR

FatMax étanche - 8 compartiments



	DÉSIGNATION	UT	CODE	PPHT (€)
955.0027.72	ORGANISEUR ETANCHE 8 COMP.FATMAX FMST1-72378	U	4026V.9	34,65



SAC A OUTILS

Sac à outils textile - Tissu



	DÉSIGNATION	UT	CODE	PPHT (€)
887.0063.90	SAC SEAU TEXTILE PORTE OUTIL VIRAX 382655	U	9702G.7	63,90

Le PPHT comprend l'ecopart (€)

OUTILLAGE UNIVERSEL

OUTILS POUR BATIMENT



ELECTRICITE

Jeu de clés de montage -MC4- - Multi-Contact



DÉSIGNATION	UT	CODE	PPHT (€)
999.0009.15 CLES DE MONTAGE MATRICE MC4 9749662	U	A09CP.6	9,15



ELECTRICITE

Outil à dénuder - Universel Ergostrip



DÉSIGNATION	UT	CODE	PPHT (€)
889.0045.30 OUTIL A DENUDER UNIV.ERGOSTRIP 16 95 01 SB	U	1007C.5	45,30



ELECTRICITE

Pince de préhension - Becs de cigogne - demi-ronds avec tranchant



DÉSIGNATION	UT	CODE	PPHT (€)
889.0042.85 PINCE BEC CIGOGNE 200MM BEC COUDE 26 26 200	U	54519.4	42,85



ELECTRICITE

Pince à dénuder automatique - MultiStrip 10



DÉSIGNATION	UT	CODE	PPHT (€)
999.0101.65 PINCE A DENUDER AUTO.MULTISTRIP 10 1242195	U	8232N.5	101,65



ELECTRICITE

Multimètre - Digital



DÉSIGNATION	UT	CODE	PPHT (€)	ECOPART (€)
880.0016.89 MULTIMETRE DIGITAL KS 150.1495	U	5848N.7	19,91	0,04



ELECTRICITE

Testeur universel - Test en courant continu ou alternatif - Indicateur par LED



DÉSIGNATION	UT	CODE	PPHT (€)	ECOPART (€)
880.0017.21 TESTEUR UNIVERSEL KS 550.1501	U	2140C.1	20,28	0,03

Le PPHT comprend l'ecopart (€)

OUTILLAGE UNIVERSEL

OUTILS POUR BATIMENT



MAÇONNERIE

Joint - Assortiment Joints toriques



DÉSIGNATION	UT	CODE	PPHT (€)
880.0025.73 JOINT TORIQUE - ASSORTIMENT 419- KS 970.0130	U	2962M.6	30,27

EQUIPEMENT



ESCABEAU

Pro 54



DÉSIGNATION	UT	CODE	PPHT (€)
880.0135.00 ESCABEAU ALU PRO54 3 MARCHES CENTAURE 309203	U	30051.7	135,00
880.0153.00 ESCABEAU ALU PRO54 4 MARCHES CENTAURE 309204	U	30053.3	153,00
880.0172.20 ESCABEAU ALU PRO54 5 MARCHES CENTAURE 309205	U	16671.3	172,20
880.0204.60 ESCABEAU ALU PRO54 6 MARCHES CENTAURE 309206	U	3005B.5	204,60
810.0226.20 ESCABEAU ALU PRO54 7 MARCHES CENTAURE 309207	U	66388.0	226,20



PILE

Advanced



DÉSIGNATION	UT	CODE	PPHT (€)
000.0008.36 PILE ADVANCED.D/LR20 FSB2 ENERGIZER EELR20	U	7510X.1	8,36



PILE

Alcaline MAX



DÉSIGNATION	UT	CODE	PPHT (€)
000.0007.26 PILE ALC.MAX ENERGIZER 6LR61 9V -1- EMXLR622	U	2276M.6	7,26



PILE

Alcaline MAX+



DÉSIGNATION	UT	CODE	PPHT (€)
000.0009.22 PILE AA LR6 1.5V ALCALINE MAX+ -4- EMPLR6	U	2010R.9	9,22
000.0009.22 PILE AAA LR03 1.5V ALCALINE MAX+ -4- EMPLR03	U	2010S.7	9,22
000.0009.22 PILE 6LR61 9V ALCALINE MAX+ -1- EMPLR622	U	2010R.2	9,22
000.0018.08 PILE AA LR6 1.5V ALCAL MAX+ -8+4- EMPLR68+4	U	192E8.3	18,08

OUTILLAGE UNIVERSEL

EQUIPEMENT



PILE
Alcaline MAX+
- suite



	DÉSIGNATION	UT	CODE	PPHT (€)
000.0018.08	PILE AAA LR03 1.5V ALCAL.MAX+ -8+4- EMPLR38+4	U	192EF.7	18,08
000.0009.22	PILE C LR14 1.5V ALCALINE MAX+ EMPLR14	U	201QU.2	9,22



PILE
Alcaline miniature



	DÉSIGNATION	UT	CODE	PPHT (€)
000.0007.47	PILE ALCALINE A23 12V LITH.639336 -2- E23AB2	U	176ZJ.8	7,47



PILE
Lithium miniature



	DÉSIGNATION	UT	CODE	PPHT (€)
000.0016.81	PILE PHOTO LITHIUM 6V ENERGIZER EL223	U	60649.1	22,41
000.0008.50	PILE CR2032 3V LITHIUM ULTIMATE -2- E2032B2S	U	201R9.3	8,50



PILE
Rechargeable



	DÉSIGNATION	UT	CODE	PPHT (€)
000.0025.02	PILE RECHARG.AAA 700MAH 1.2-LOT- EHR03 638626	U	2609E.0	25,02



ECLAIRAGE
Baladeuse LED - LED COB 3W



	DÉSIGNATION	UT	CODE	PPHT (€)	ECOPART (€)
880.0013.60	BALADEUSE D'ATELIER RECH.LED 180 KS 150.4495	U	300TP.0	16,01	0,01

OUTILLAGE UNIVERSEL

EQUIPEMENT



ECLAIRAGE
Projecteur LED mobile 30W



	DÉSIGNATION	UT	CODE	PPHT (€)	ECOPART (€)
880.0086.70	PROJECTEUR MOBILE LED 30W 3000LM KS 150.4352	U	332FW.6	102,17	0,17



ECLAIRAGE
Projecteur de chantier LED - M18



	DÉSIGNATION	UT	CODE	PPHT (€)	ECOPART (€)
891.0189.00	PROJECTEUR CHANTIER M18 AL-0 4932430392	U	3705X.5	189,17	0,17

100% EXPO



Faites de nos salles Expo
vos outils de vente

Le PPHT comprend l'ecopart (€)

OUTILLAGE ELECTROPORTATIF

OUTILS DE PERÇAGE ET BURINAGE



PERCEUSE - VISSEUSE SANS FIL

A percussion - M18 FPD2



	DÉSIGNATION	UT	CODE	PPHT (€)	ECOPART (€)
000.0529.00	PERCEUSE PERCU.M18 FPD2-502X 4933464264	U	196FV.7	529,42	0,42



PERFORATEUR - BURINEUR SANS FIL

SDS Max - M18 FHM



	DÉSIGNATION	UT	CODE	PPHT (€)	ECOPART (€)
884.1289.99	PERFORATEUR SDS-MAX M18 FHM-121C 4933464894	U	212MW.3	1290,41	0,42



PERFORATEUR - BURINEUR SANS FIL

SDS Plus - M18 FHX



	DÉSIGNATION	UT	CODE	PPHT (€)	ECOPART (€)
884.0419.00	PERFORATEUR SDS+ 18V FHX-DX 4933478888	U	349LP.9	419,42	0,42
884.0699.00	PERFORATEUR SDS+ 18V FHX-552X 4933478889	U	34706.1	699,42	0,42

ACCESSOIRES PERÇAGE ET BURINAGE



FORET

EXPERT SDS Plus-7x



	DÉSIGNATION	UT	CODE	PPHT (€)
000.0009.25	FORET BET.SDS+ 7XEXP. 6X100 BOSCH 2608900072	U	319U.7.4	9,25
000.0010.20	FORET BET.SDS+ 7XEXP. 8X100 BOSCH 2608900088	U	319UB.5	10,20
000.0011.47	FORET BET.SDS+ 7XEXP. 10X100 BOSCH 2608900097	U	319TR.6	11,47
000.0013.85	FORET BET.SDS+ 7XEXP. 12X100 BOSCH 2608900108	U	319TX.3	13,85
000.0028.00	FORET BET.SDS+ 7XEXP. 14X200 BOSCH 2608900121	U	319U5.8	28,00
000.0031.34	FORET BET.SDS+ 7XEXP. 16X150 BOSCH 2608900130	U	319U6.6	31,34



FORET

SPEED-X - Pour marteau perforateur - Pour béton - Emmanchement SDS Max-7 - Long Life



	DÉSIGNATION	UT	CODE	PPHT (€)
880.0427.26	FORET SDS MAX-7 52X400X520 BOSCH 2608586807	U	5218E.6	427,26

Le PPHT comprend l'ecopart (€)

OUTILLAGE ELECTROPORTATIF

ACCESSOIRES PERÇAGE ET BURINAGE



FORET

SPEED-X - Pour marteau perforateur - Pour béton - Emmanchement SDS Max-7 - Long Life - suite



	DÉSIGNATION	UT	CODE	PPHT (€)
880.0319.75	FORET SDS MAX-7 45X400X520 BOSCH 2608586806	U	4756C.2	319,75



FORET

Hard Ceramic HEX-9 EXPERT



	DÉSIGNATION	UT	CODE	PPHT (€)
880.0015.03	FORET CERAM.HEX-9 EXP.6X90MM BOSCH 2608900590	U	311W6.1	15,03
880.0020.44	FORET CERAM.HEX-9 EXP.8X90MM BOSCH 2608900592	U	311W9.5	20,44



FORET

Multimat HEX-9 Expert



	DÉSIGNATION	UT	CODE	PPHT (€)
000.0005.71	FORET MULTI-MAT HEX-9 6X60X100MM 2608900574	U	311WR.0	5,71
000.0007.07	FORET MULTI-MAT HEX-9 8X50X100MM 2608900581	U	311WT.6	7,07
000.0009.51	FORET MULTI-MAT HEX-9 10X90 BOSCH 2608900582	U	311WU.3	9,51



FORET EN COFFRET

HSS POINTTEQ Coffret de 25 pièces



	DÉSIGNATION	UT	CODE	PPHT (€)
880.0051.04	FORET HSS POINTTEQ 1-13MM-25-BOSCH 2608577352	U	169BG.6	51,04



FORET EN COFFRET

EXPERT Béton SDS+ 7X - Jeu de 3 forets



	DÉSIGNATION	UT	CODE	PPHT (€)
000.0028.40	FORET BET.EXP.SDS+ 7X-COFF.3-BOSCH 2608900196	U	336PB.4	28,40

OUTILLAGE ELECTROPORTATIF

ACCESSOIRES PERÇAGE ET BURINAGE



FORET EN COFFRET

EXPERT Béton SDS+ 7X - Jeu de 7 forets



	DÉSIGNATION	UT	CODE	PPHT (€)
000.0064.39	FORET BET.EXP.SDS+ 7X-COFF.7-BOSCH 2608900195	U	336PM.2	64,39



BURIN

SDS-plus - Plat - Long Life



	DÉSIGNATION	UT	CODE	PPHT (€)
880.0016.42	BURIN PLAT SDS + 250MM BOSCH 2609390394	U	2688A.3	16,42



BURIN

SDS-plus - Pointu - Long Life



	DÉSIGNATION	UT	CODE	PPHT (€)
880.0016.42	BURIN POINTU SDS+ 250MM BOSCH 2609390394	U	4550B.2	16,42



BURIN

SDS-max - Bêche, Long Life



	DÉSIGNATION	UT	CODE	PPHT (€)
880.0073.07	BURIN BECHE SDSMAX 400X80MM BOSCH 2608690198	U	9248R.9	73,07



BURIN

SDS-max - Pointu RTec Speed, Long Life



	DÉSIGNATION	UT	CODE	PPHT (€)
880.0028.36	BURIN POINTU SDS MAX 400MM BOSCH 2608690167	U	5218F.4	28,36



BURIN

SDS-max - Plat RTec Sharp, Long Life



	DÉSIGNATION	UT	CODE	PPHT (€)
880.0028.36	BURIN PLAT SDS MAX AF 400MM BOSCH 2608690124	U	5218G.2	28,36

OUTILLAGE ELECTROPORTATIF

ACCESSOIRES PERÇAGE ET BURINAGE



BURIN EN LOT

SDS-plus - Lot de 3 pièces - Pointu - Plat - Auto-affûtant



	DÉSIGNATION	UT	CODE	PPHT (€)
880.0058.35	BURIN POINT.PLAT CARR.SDS+ 3 BOSCH 2607019159	U	8073P.5	58,35



COURONNE TREPAN

Pour adaptateur six pans - SDS Plus-9



	DÉSIGNATION	UT	CODE	PPHT (€)
880.0092.61	COURONNE TREPAN SDS PLUS 68 BOSCH 2608550076	U	1265I.9	92,61



COURONNE TREPAN

En deux parties - Core Cutter - SDS Max-9



	DÉSIGNATION	UT	CODE	PPHT (€)
880.0267.04	COURONNE TREPAN SDS-MAX 68 BOSCH 2608580521	U	5532L.2	267,04



COURONNE TREPAN

Porte-outil - SDS Max - En deux parties



	DÉSIGNATION	UT	CODE	PPHT (€)
880.0116.26	PORTE OUTIL COUR.SDS M.460MM BOSCH 2608580528	U	5533E.4	116,26



COURONNE TREPAN

Porte-outil - SDS Plus



	DÉSIGNATION	UT	CODE	PPHT (€)
880.0061.18	PORTE OUTIL SDS+ 220MM BOSCH 2608598110	U	3838I.0	61,18



SCIE TREPAN

Bi-métal Progressor



	DÉSIGNATION	UT	CODE	PPHT (€)
880.0014.73	SCIE TREPAN PROGRESSOR 25MM BOSCH 2608594203	U	207HS.7	17,33
880.0015.03	SCIE TREPAN PROGRESSOR 29MM BOSCH 2608594205	U	214XM.3	17,68
880.0014.15	SCIE TREPAN PROGRESSOR 35MM BOSCH 2608594209	U	207HT.5	18,87
880.0017.05	SCIE TREPAN PROGRESSOR 40MM BOSCH 2608594212	U	207HU.2	20,06
880.0018.06	SCIE TREPAN PROGRESSOR 44MM BOSCH 2608594215	U	218ND.6	21,25
880.0019.28	SCIE TREPAN PROGRESSOR 51MM BOSCH 2608594218	U	207HV.0	22,68

OUTILLAGE ELECTROPORTATIF

ACCESSOIRES PERÇAGE ET BURINAGE



SCIE TREPAN
Bi-métal Progressor
- suite



DÉSIGNATION	UT	CODE	PPHT (€)
880.0024.90 SCIE TREPAN PROGRESSOR 60MM BOSCH 2608594224	U	207HX.6	29,30



SCIE TREPAN
Carbure



DÉSIGNATION	UT	CODE	PPHT (€)
880.0022.88 SCIE TREPAN PROGRESSOR 54MM BOSCH 2608594220	U	214LP.5	26,92



SCIE TREPAN
EXPERT Multimateriaux



DÉSIGNATION	UT	CODE	PPHT (€)
000.0040.83 SCIE TREPAN EXP.MULTIM. 51MM BOSCH 2608900427	U	319WC.1	40,83



SCIE TREPAN
Progressor - Bois et métal - HSS - Bi-Metal
avec adaptateur Power-Change - Long Life



DÉSIGNATION	UT	CODE	PPHT (€)
880.0014.73 SCIE TREPAN PROGRESSOR 22MM BOSCH 2608594201	U	213JE.8	17,33
880.0016.04 SCIE TREPAN PROGRESSOR 32MM BOSCH 2608594207	U	217VQ.2	18,87
880.0025.70 SCIE TREPAN PROGRESSOR 67MM BOSCH 2608594227	U	219CV.0	30,24
880.0042.53 SCIE TREPAN PROGRESSOR 127MM BOSCH 2608594245	U	213JC.3	56,71



SCIE TREPAN
Adaptateur - Mandrin Power Change
Plus



DÉSIGNATION	UT	CODE	PPHT (€)
880.0025.23 ADAPTATEUR POWERCHANGE+ 11MM BOSCH 2608594265	U	219KU.4	29,68
880.0032.77 ADAPTATEUR POW.CHANGE+ SDS+ BOSCH 2608594266	U	214A1.4	32,77



SCIE TREPAN EN COFFRET
Progressor électrique



DÉSIGNATION	UT	CODE	PPHT (€)
880.0188.62 SCIE TREPAN - COFF.11PCS-BOSCH 2608594194	U	214SY.5	221,91

OUTILLAGE ELECTROPORTATIF

ACCESSOIRES PERÇAGE ET BURINAGE



SCIE TREPAN EN COFFRET
Progressor plombier



DÉSIGNATION	UT	CODE	PPHT (€)
880.0126.44 SCIE TREPAN PLOMBIER -9PCS- BOSCH 2608594191	U	228YC.2	168,59



FORET DE CENTRAGE POUR SCIE TREPAN
HSS-G - Montage sans clé Bosch Power Change



DÉSIGNATION	UT	CODE	PPHT (€)
880.0008.66 FORET CENTRAGE HSS-G PROGR. BOSCH 2608584676	U	24010.1	8,66



EMBOUT ET DOUILLE
Douille - Pour vis à tête six pans



DÉSIGNATION	UT	CODE	PPHT (€)
880.0039.46 DOUILLE AIMANTEE -COF.6- BOSCH 2608551079	U	90816.0	39,46



EMBOUT ET DOUILLE
Coffret Embout/Douille/Foret - Embouts de
vissage ABS - 44 pièces



DÉSIGNATION	UT	CODE	PPHT (€)
000.0049.34 EMBOUT VISS.EXTRAHARD -44PCS-BOSCH 2607017692	U	337XV.5	49,34



EMBOUT ET DOUILLE
Coffret Embout/Douille/Foret - Métal - 35
pièces



DÉSIGNATION	UT	CODE	PPHT (€)
880.0055.85 EMBOUT VISSAGE METAL -SET35- BOSCH 2607017328	U	3886S.7	55,85



EMBOUT ET DOUILLE
Coffret Embout/Douille/Foret - Embouts - 32
pièces



DÉSIGNATION	UT	CODE	PPHT (€)
880.0017.50 EMBOUT VISSAGE MIXTE -32PCS- BOSCH 2607017319	U	3830T.2	17,50

OUTILLAGE ELECTROPORTATIF

ACCESSOIRES PERÇAGE ET BURINAGE



MECHE A BOIS

Hélicoïdale - Set de 7 pièces



	DÉSIGNATION	UT	CODE	PPHT (€)
880.0010.53	MECHE A BOIS -7- BOSCH 2607017034	U	7846G.8	10,53



SCIE CLOCHE

Emporte-pièce - Pour découpe et poinçonnage des tôles et de l'acier doux



	DÉSIGNATION	UT	CODE	PPHT (€)
880.0042.20	EMPORTE-PIECE 35MM KS 129.0035	U	07576.2	49,65



FORET

Coffret - Sds+



	DÉSIGNATION	UT	CODE	PPHT (€)
885.0057.51	FORET SDS PLUS MX4 4T.COFFRET -7- 4932478626	U	2950V.2	57,51



BURIN

Bèche SDS MAX



	DÉSIGNATION	UT	CODE	PPHT (€)
885.0029.90	BURIN BECHE SDS MAX 400X50MM 4932343743	U	1413Y.0	29,90



BURIN

Plat SDS MAX



	DÉSIGNATION	UT	CODE	PPHT (€)
885.0013.90	BURIN PLAT SDS MAX 25X400MM 4932343738	U	1427K.1	13,90

OUTILLAGE ELECTROPORTATIF

ACCESSOIRES PERÇAGE ET BURINAGE



BURIN

Pic SDS MAX



	DÉSIGNATION	UT	CODE	PPHT (€)
885.0013.90	BURIN PIC SDS MAX 400MM 4932343735	U	1427L.9	13,90



DOUILLE

Coffret Shockwave Impact Duty



	DÉSIGNATION	UT	CODE	PPHT (€)
000.0019.90	COFFRET FORET+EMBOUITS SHOCKW 32PCS 4932464240	U	183XG.1	19,90

OUTILS DE FORAGE ET CAROTTAGE



CAROTTEUSE

Picus DP Basic-Pack - Avec couronnes diamantées



	DÉSIGNATION	UT	CODE	PPHT (€)	ECOPART (€)
000.2584.61	CAROTTEUSE PICUS DP BAS.PACK REMS 180016 R220	U	281F8.3	2585,49	0,88

ACCESSOIRES FORAGE ET CAROTTAGE



CAROTTAGE

Couronne de carottage à sec diamantée laser TDKB LS - Profondeur de carottage 320 mm



	DÉSIGNATION	UT	CODE	PPHT (€)
000.0186.79	COURONNE CAROT.TDKB-LS 62X320 REMS 181506 R	U	298KN.1	186,79
000.0229.35	COURONNE CAROT.TDKB-LS 82X320 REMS 181510 R	U	324EK.7	229,35

OUTILLAGE ELECTROPORTATIF

OUTILS DE COUPE



MEULEUSE SANS FIL
D'angle GWS - GWS 10,8-76 V



	DÉSIGNATION	UT	CODE	PPHT (€)	ECOPART (€)
000.0175.00	MEULEUSE ANG.GWS 12V-76 SOLO BOSCH 06019F2003	U	8288M.0	175,42	0,42



MEULEUSE SANS FIL
D'angle GWS - GWS 18V-7



	DÉSIGNATION	UT	CODE	PPHT (€)	ECOPART (€)
000.0195.00	MEULEUSE ANG.GWS 18V-7 SOLO BOSCH 06019H9002	U	299UV.0	195,42	0,42



SCIE SABRE SANS FIL
GSA - 18 V-LI



	DÉSIGNATION	UT	CODE	PPHT (€)	ECOPART (€)
011.0249.00	SCIE SABRE GSA 18V-LI SOLO BOSCH 060164J007	U	2364Y.7	249,42	0,42



MEULEUSE SANS FIL
M12 FCOT Compacte - FCOT-422X



	DÉSIGNATION	UT	CODE	PPHT (€)	ECOPART (€)
884.0359.00	MEULEUSE ANGL.M12 FUEL FCOT-422X 4933464619	U	202SQ.7	359,42	0,42



MEULEUSE SANS FIL
D'ANGLE M18 ONE FSAGV125XPDB - ONEFSAGV125XPDB-0X



	DÉSIGNATION	UT	CODE	PPHT (€)	ECOPART (€)
884.0359.00	MEULEUSE ANG.M18 ONEFSAGV125XPDB-0X 4933478434	U	320GY.6	359,42	0,42



SCIE SABRE SANS FIL
M18 FHZ



	DÉSIGNATION	UT	CODE	PPHT (€)	ECOPART (€)
884.0279.00	SCIE SABRE COMPACTE M18FHZ0X NUE 4933459887	U	171XA.9	279,42	0,42

Le PPHT comprend l'ecopart (€)

OUTILLAGE ELECTROPORTATIF

OUTILS DE COUPE



SCIE SABRE SANS FIL
M18 FSZ



	DÉSIGNATION	UT	CODE	PPHT (€)	ECOPART (€)
884.0399.00	SCIE SABRE M18 FSZ-0 4933478293	U	311EA.4	399,42	0,42



SCIE SAUTEUSE SANS FIL
A poignée - M18 FJS



	DÉSIGNATION	UT	CODE	PPHT (€)	ECOPART (€)
884.0359.00	SCIE SAUTEUSE M18 FJS-0X POMMEAU 4933464726	U	214PH.0	359,42	0,42



SCIE CIRCULAIRE SANS FIL
M18 BLC566



	DÉSIGNATION	UT	CODE	PPHT (€)	ECOPART (€)
884.0399.00	SCIE CIRCULAIRE M18 BLC566-0X 4933464589	U	211YK.2	399,42	0,42

ACCESSOIRES DE COUPE



DISQUE A TRONÇONNER
Best for Ceramic - Extraclean Turbo - Diamanté



	DÉSIGNATION	UT	CODE	PPHT (€)
880.0043.87	DISQUE DIAMANT CERAM. D125MM BOSCH 2608602479	U	05803.2	43,87



DISQUE A TRONÇONNER
Expert for Inox



	DÉSIGNATION	UT	CODE	PPHT (€)
880.0009.33	DISQUE TRONC.INOX 76MM BOSCH 2608601520	U	85560.9	9,33

OUTILLAGE ELECTROPORTATIF

ACCESSOIRES DE COUPE



DISQUE A TRONÇONNER

Expert Hard ceramic - Diamanté



	DÉSIGNATION	UT	CODE	PPHT (€)
000.0023.63	DISQUE DIAMANT EXPERT D76MM BOSCH 2608900652	U	342GJ.9	23,63



DISQUE A TRONÇONNER

Multi-construction - Multi Construction - Moyeu plat



	DÉSIGNATION	UT	CODE	PPHT (€)
880.0002.58	DISQUE MULTICONS. 125X1,6 BOSCH 2608602383	U	33137.1	2,58



DISQUE A TRONÇONNER

Standard for universal - Diamanté



	DÉSIGNATION	UT	CODE	PPHT (€)
880.0020.70	DISQUE DIAMANT UNIV. 125MM BOSCH 2608615059	U	163AZ.5	20,70
880.0042.70	DISQUE DIAMANT UNIV. D230MM BOSCH 2608615065	U	163B0.4	42,70



LAME SCIE SAUTEUSE

Basic for Wood - Coupe économique - T 111 C - Bois tendre, panneaux 4-50 mm



	DÉSIGNATION	UT	CODE	PPHT (€)
880.0007.27	LAME SCIE SAUTEUSE T111C -5- BOSCH 2608630033	U	16100.0	7,27



LAME SCIE SAUTEUSE

Clean for Wood - T 101 BR - Bois tendre, panneaux 3-30 mm



	DÉSIGNATION	UT	CODE	PPHT (€)
880.0009.88	LAME SCIE SAUTEUSE T101BR-5- BOSCH 2608630014	U	38987.4	9,88



LAME SCIE SABRE

Endurance for Heavy Metal - Très longue durée de vie - S 1125 HBF



	DÉSIGNATION	UT	CODE	PPHT (€)
880.0037.37	LAME SCIE SABRE S1125HBF -5- BOSCH 2608658011	U	190CH.9	37,37

OUTILLAGE ELECTROPORTATIF

ACCESSOIRES DE COUPE



LAME SCIE SABRE

Endurance for Heavy Metal - Très longue durée de vie - S 1225 HBF



	DÉSIGNATION	UT	CODE	PPHT (€)
880.0049.35	LAME SCIE SABRE S1225HBF -5- BOSCH 2608658013	U	190CJ.6	49,35



LAME SCIE SABRE

Expert Thick Tough Metal - Lame carbure - S 1155 HHM - Métal dur



	DÉSIGNATION	UT	CODE	PPHT (€)
000.0036.62	LAME SCIE SABRE S1155CH 225 BOSCH 2608900368	U	311X.5	36,62



LAME SCIE SABRE

Flexible for Wood and Metal - Résistante à la rupture - S 1122 VF



	DÉSIGNATION	UT	CODE	PPHT (€)
880.0031.25	LAME SCIE SABRE S1122VF -5- BOSCH 2608654981	U	169L2.7	31,25



LAME SCIE SABRE

Flexible for Metal - Résistance à la rupture - S 522 AF - Tôle fine 0.7-3 mm



	DÉSIGNATION	UT	CODE	PPHT (€)
880.0008.30	LAME SCIE SABRE S 522 AF -2- BOSCH 2608656267	U	60208.6	8,30



LAME SCIE SABRE

Flexible for Metal - Résistance à la rupture - S 522 EF - Tôle fine 1.5-4 mm



	DÉSIGNATION	UT	CODE	PPHT (€)
880.0011.25	LAME SCIE SABRE S522EF -2- BOSCH 2608657721	U	7052V.9	11,25



LAME SCIE SABRE

Flexible for Metal - Résistance à la rupture - S 922 BF - Tôle épaisse 3-8 mm



	DÉSIGNATION	UT	CODE	PPHT (€)
880.0025.00	LAME SCIE SABRE S922BF -5- BOSCH 2608656014	U	1617F.0	25,00

OUTILLAGE ELECTROPORTATIF

ACCESSOIRES DE COUPE



LAME SCIE SABRE

Coffret - Set de démolition



DÉSIGNATION	UT	CODE	PPHT (€)
885.0041.90 LAME SCIE SABRE EGOINE -SET 10- 4922211	U	246DT.7	41,90



LAME SCIE SAUTEUSE

Pour bois et métal



DÉSIGNATION	UT	CODE	PPHT (€)
885.0007.79 LAME SCIE SAUTEUSE SET5 PL/BOIS/M. 4932345825	U	33166.8	7,79

ACCESSOIRES DE CLOUAGE



CLOU POUR CLOUAGE GAZ MULTIMATERIAUX

Matériaux tendre et creux - Pour Pulsa 800 / 500



DÉSIGNATION	UT	CODE	PPHT (€)
880.0125.22 TAMPON C6-25+GAZ P800/500 -BTE500-SPIT 057541	U	94099.9	125,22



ACCESSOIRES

Crochet métallique - Multiusage



DÉSIGNATION	UT	CODE	PPHT (€)
880.0036.43 CROCHET METAL P.TUBE 16 -BTE200-SPIT 057495	U	35294.8	45,54
880.0038.51 CROCHET METAL P.TUBE 20 -BTE200-SPIT 057496	U	35298.9	48,14
880.0048.84 CROCHET METAL P.TUBE 25 -BTE200-SPIT 057497	U	35299.7	61,05

OUTILS SPECIFIQUES



BATTERIE

Li-Ion - ProCore



DÉSIGNATION	UT	CODE	PPHT (€)
000.0185.00 BATTERIE PROCORE 18V 8.0AH BOSCH 1600A0166K	U	210HK.5	185,00

OUTILLAGE ELECTROPORTATIF

OUTILS SPECIFIQUES



BATTERIE

Li-Ion - Starter set - 2 GBA + Chargeur



DÉSIGNATION	UT	CODE	PPHT (€)	ECOPART (€)
000.0129.00 BATTERIE SET 2XGBA 12V 3AH +GAL12V 1600A019RD	U	264WZ.5	129,12	0,12



BATTERIE

Li-Ion - Starter set - 2 ProCORE + Chargeur



DÉSIGNATION	UT	CODE	PPHT (€)	ECOPART (€)
000.0235.00 BATTERIE PROCORE 4AH+GAL18V-40 -2- 1600A01BA3	U	209UZ.2	235,12	0,12



DECAPEUR

Thermique



DÉSIGNATION	UT	CODE	PPHT (€)	ECOPART (€)
880.0096.67 DECAPEUR THERMIQUE 4 BUSES KS 960.1190	U	0924F.0	114,15	0,42



OUTIL MULTI-TOOL

M18 FMT



DÉSIGNATION	UT	CODE	PPHT (€)	ECOPART (€)
884.0319.00 OUTIL MULTITOOL M18 FMT-DX 4933478491	U	309KG.9	319,42	0,42



OUTIL MULTI-TOOL

Lame Starlock set - Set rénovation



DÉSIGNATION	UT	CODE	PPHT (€)
885.0169.00 LAME MULTITOOL SET RENOVATION -8PCS- 48906088	U	299E9.4	169,00



BATTERIE

LI-ION - M18 B5



DÉSIGNATION	UT	CODE	PPHT (€)
891.0165.00 BATTERIE M18 B5 LI-ION 18V 5A 4932430483	U	8181M.8	165,00

Le PPHT comprend l'ecopart (€)

Les tarifs et disponibilités de nos produits peuvent évoluer sans préavis

RICHARDSON

387

OUTILLAGE ELECTROPORTATIF

OUTILS SPECIFIQUES



BATTERIE
Pack - NRJ 18V 5Ah



	DÉSIGNATION	UT	CODE	PPHT (€)	ECOPART (€)
891.0299.00	PACK BATT.NRG-502 M18 2X5AH +C12 C 4933459217	U	0921B.2	299,12	0,12



RADIO DE CHANTIER
Enceinte de chantier bluetooth - M12-18 JSSP-0



	DÉSIGNATION	UT	CODE	PPHT (€)	ECOPART (€)
884.0239.00	ENCEINTE BLUETOOTH 18V M18.JSSP0 4933459275	U	172N6.0	239,08	0,08



CHARGEUR DE BATTERIE
Rapide - Li-Ion / 22V



	DÉSIGNATION	UT	CODE	PPHT (€)	ECOPART (€)
000.0175.42	CHARGEUR RAPIDE LI-ION 22V REMS 571575R220	U	9371Q.0	175,50	0,08

MESURE ET CONTROLE

OUTILS DE MESURE



CALIBRAGE
Calibre à coulisse - A bouble bec - Inox



	DÉSIGNATION	UT	CODE	PPHT (€)	ECOPART (€)
880.0019.55	PIED A COULISSE KS 300.0510	U	0353C.7	23,00	



MESURE OPTIQUE ET ULTRASON
Laser vert 3 lignes 360° - M12 3PL



	DÉSIGNATION	UT	CODE	PPHT (€)	ECOPART (€)
884.0699.00	LASER 3 LIGNES M12 3PL-401C 4933478102	U	300LN.4	699,12	0,12



HUMIDITE
Testeur



	DÉSIGNATION	UT	CODE	PPHT (€)	ECOPART (€)
880.0026.38	TESTEUR HUMIDITE IMT23208	U	210LX.6	35,29	0,12

STANLEY

ANGLE ET NIVEAU
Niveau trapézoïdal - Fatmax - Semelle aimantée MALH



	DÉSIGNATION	UT	CODE	PPHT (€)	ECOPART (€)
955.0049.27	NIVEAU AIMANTE FATMAX 40CM STANLEY 1-42-421	U	8819G.9	61,59	

STANLEY

ANGLE ET NIVEAU
Niveau Torpedo - Magnétique



	DÉSIGNATION	UT	CODE	PPHT (€)	ECOPART (€)
955.0036.02	NIVEAU TORPEDO ALU.MAG.FATMAX XL25CM 0-43-609	U	0657E.5	45,03	

STANLEY

MESURE COURTE
Mètre ruban avec blocage - FatMax - Blade Armor



	DÉSIGNATION	UT	CODE	PPHT (€)	ECOPART (€)
955.0028.90	MESURE BLADE ARM. 5MX32MM STANLEY FMHT81556-0	U	182HJ.8	36,13	

Le PPHT comprend l'ecopart (€)

MESURE ET CONTROLE

OUTILS DE MESURE

STANLEY

MESURE COURTE

Mètre ruban avec blocage - FatMax - Xtreme
Blade Armor



	DÉSIGNATION	UT	CODE	PPHT (€)
955.0036.46	MESURE BLADE ARM. 5MX32MM STANLEY 0-33-887	U	0768D.4	45,57
955.0043.74	MESURE BLADE ARM. 8MX32MM STANLEY 0-33-892	U	0769I.2	54,68

STANLEY

MESURE COURTE

Mètre ruban avec blocage -
Powerlock - Standard



	DÉSIGNATION	UT	CODE	PPHT (€)
955.0018.91	MESURE POWERLOCK 5M X 19MM STANLEY 0-33-552	U	0706J.7	23,64

STANLEY

TRAÇAGE

Marqueur - Stanley



	DÉSIGNATION	UT	CODE	PPHT (€)
955.0003.53	MARQUEUR POINTE FINE LS STANLEY 0-47-316	U	1734J.1	4,41

STANLEY

TRAÇAGE

Marqueur - Mini-marqueur



	DÉSIGNATION	UT	CODE	PPHT (€)
955.0001.18	MINI MARQUEUR NOIR -VRAC- STANLEY 1-47-324	U	6270J.0	1,48

STANLEY

TRAÇAGE

Cordeau



	DÉSIGNATION	UT	CODE	PPHT (€)
955.0008.12	CORDEAU TRACEUR 30M STANLEY 0-47-440	U	0839J.7	10,15

STANLEY

TRAÇAGE

Cordeau - Fatmax



	DÉSIGNATION	UT	CODE	PPHT (€)
955.0023.02	CORDEAU TRACEUR 30+BIB.POUDRE FATMAX 0-47-681	U	7333H.6	28,78

Le PPHT comprend l'ecopart (€)

MESURE ET CONTROLE

OUTILS DE MESURE

STANLEY

TRAÇAGE

Poudre à tracer



	DÉSIGNATION	UT	CODE	PPHT (€)
955.0003.30	POUDRE A TRACER STANLEY 1-47-404	U	0772D.8	4,12
955.0003.30	POUDRE A TRACER 115G BLEU STANLEY 1-47-403	U	8530S.1	4,12

OUTILS DE CONTROLE

Schneider Electric

TESTEUR DE TENSION

Led et alarme



	DÉSIGNATION	UT	CODE	PPHT (€)	ECOPART (€)
880.0024.54	TESTEUR DE TENSION CAT IV IMT23209	U	215MZ.1	24,66	0,12

STANLEY

INSTRUMENT DE DETECTION

Testeur d'humidité - Double unité de mesure, écran
LCD avec graphique



	DÉSIGNATION	UT	CODE	PPHT (€)	ECOPART (€)
955.0070.34	TESTEUR D'HUMIDITE STANLEY 0-77-030	U	43027.2	88,05	0,12

virax

TEST

Contrôleur d'étanchéité complet - Gaz



	DÉSIGNATION	UT	CODE	PPHT (€)
887.0349.38	CONTROLEUR D'ETANCHEITE GAZ 60MB VIRAX 262080	U	3729B.0	388,20

SECURITE ET PROTECTION

PROTECTION DE LA PERSONNE

Castolin PRO

LUNETTES

Lunettes de protection



	DÉSIGNATION	UT	CODE	PPHT (€)
883.0012.64	LUNETTES PROTECT.SOUD.TEINTE 5 73525-6 657887	U	19542.0	16,86



VETEMENT

Pantalon - Cargo - Urban camo



	DÉSIGNATION	UT	CODE	PPHT (€)
000.0057.51	PANTALON CARGO CAMO T.S 173172-C7267	U	243XZ.8	57,51
000.0057.51	PANTALON CARGO CAMO T.M 173172-C7267	U	205CS.6	57,51
000.0057.51	PANTALON CARGO CAMO T.L 173172-C7267	U	205EX.3	57,51
000.0057.51	PANTALON CARGO CAMO T.XL 173172-C7267	U	205EY.1	57,51
000.0057.51	PANTALON CARGO CAMO T.XXL 173172-C7267	U	205FO.9	57,51



VETEMENT

Pantalon - Carbon - Gris asphalte



	DÉSIGNATION	UT	CODE	PPHT (€)
000.0063.79	PANTALON CARBON GR.ASPHALTE T.S 175554-75135	U	233GB.6	63,79
000.0063.79	PANTALON CARBON GR.ASPHALTE.T.M 175554-75135	U	216V6.3	63,79
000.0063.79	PANTALON CARBON GR.ASPHALTE T.L 175554-75135	U	208TS.9	63,79
000.0063.79	PANTALON CARBON GR.ASPHALTE.T.XL 175554-75135	U	248ED.2	63,79



VETEMENT

Pantalon - Stone washed - Denim bleu



	DÉSIGNATION	UT	CODE	PPHT (€)
000.0046.40	PANTALON STONE 5P.LINGE SAL.S 170750-C6207	U	178NM.4	46,40

greensolutions

Votre partenaire énergie



SIMULEZ VOS AIDES EN QUELQUES CLICS



Une seule démarche pour bénéficier de l'ensemble des aides éligibles



Une hotline dédiée vous accompagne dans vos démarches



Chaque dossier est contrôlé pour garantir le paiement des primes



Une facture allégée en déduisant l'ensemble des aides éligibles



Toutes les aides éligibles grâce au simulateur de primes



Toutes les actualités de la rénovation énergétique

Retrouvez chez RICHARDSON les produits éligibles aux aides :



Pompe à chaleur air/eau



Chauffe-eau thermo-dynamique



Poêle à granulés



Chaudière à bois



VMC simple et double flux

www.richardson.fr/services/green-solutions

Hotline

06 27 52 64 95

Électricité et Photovoltaïque

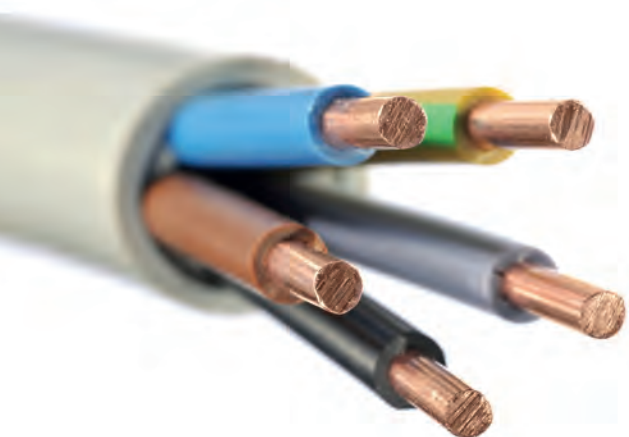

J+0
100% Dispo

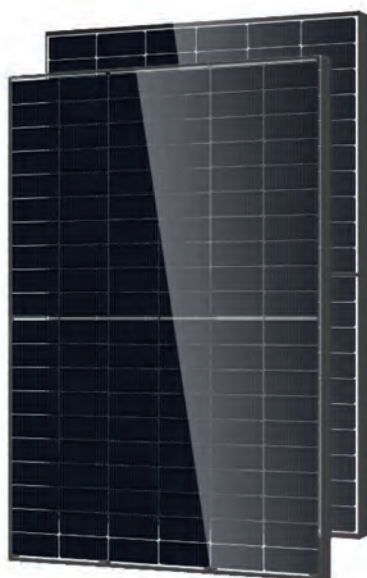

Electricité et Photovoltaïque

SOMMAIRE

APPAREILLAGE BATIMENT

APPAREILLAGE ET ENCASTREMENT 394

CABLES ET CONDUITS

CABLES, FIL ET CONDUITS 395

PROTECTION ET DISTRIBUTION

DISTRIBUTION ET GESTION DE L'ENERGIE 395

PHOTOVOLTAIQUE

FIXATIONS PHOTOVOLTAIQUES 396

ONDULEURS ET CONNECTIQUES 397

KIT PHOTOVOLTAIQUES 397

APPAREILLAGE BATIMENT

APPAREILLAGE ET ENCASTREMENT



INTERRUPTEUR DE PROXIMITE Petit modèle



DÉSIGNATION	UT	CODE	PPHT (€)
000.0026.41 INTERRUPTEUR DE PROXIMITE 3P 32A AX6102/2	U	272XC.1	35,21



INTERRUPTEUR DE PROXIMITE Grand modèle



DÉSIGNATION	UT	CODE	PPHT (€)
000.0032.74 INTERRUPTEUR DE PROXIMITE 3P 40A AX6103/2	U	272XA.5	43,66



CONNEXION Borne - 221



DÉSIGNATION	UT	CODE	PPHT (€)
880.0046.60 BORNE 2X4MM2 TRANS.ORANGE -B100- WAGO 221-412	U	82590.9	46,60
880.0008.32 BORNE 2X4MM2 TRSP.ORAN.-BL16- 221-412/996-016	U	283FG.1	8,32
880.0029.20 BORNE 3X4MM2 TRANS.ORANGE -B50- WAGO 221-413	U	8259S.5	29,20
880.0008.85 BORNE 3X4MM2 TRSP.ORAN.-BL12- 221-413/996-012	U	283FV.3	8,85
880.0025.41 BORNE 3X6MM2 TRANS.ORANGE -B30- WAGO 221-613	U	219GL.5	25,41
880.0023.28 BORNE 5X4MM2 TRANS.ORANGE -B25- WAGO 221-415	U	8259T.3	23,28



CONNEXION Borne - 2273



DÉSIGNATION	UT	CODE	PPHT (€)
880.0023.70 BORNE 3X2.5MM2 TRSP.ORANG.-B100-WAGO 2273-203	U	5507K.5	23,70



CONNEXION Gelbox - 221 / 2273



DÉSIGNATION	UT	CODE	PPHT (€)
880.0024.36 GEL BOX IPX8 221/2273 4MM2 T2-BL14- 207-1332	U	276A3.9	24,36

APPAREILLAGE BATIMENT

APPAREILLAGE ET ENCASTREMENT



INTERRUPTEURS Odace - Va et vient - 10A - A vis



DÉSIGNATION	UT	CODE	PPHT (€)	ECOPART (€)
880.0014.14 VA ET VIENT DBL 10A VIS ODACE BLANC S520214	U	350TR.1	18,88	0,02



BOITES D'ENCASTREMENT Multifix Air - Boîte étanche



DÉSIGNATION	UT	CODE	PPHT (€)
906.0001.44 BOITE ETANCHE 1P.MULTIFIX AIR 67X40 IMT35246	U	173PP.5	1,92



BOITES DE DERIVATION Mureva Box - IP55 + embout



DÉSIGNATION	UT	CODE	PPHT (€)
880.0002.46 BOITE DERIVATION IP55+EMB.60 GRIS ENN05121	U	173PH.8	3,28
880.0003.09 BOITE DERIVATION IP55+EMB.80 GRIS ENN05124	U	173PJ.5	4,12
880.0004.78 BOITE DERIVATION IP55+EMB.105 GRIS ENN05125	U	173PK.3	6,38



PRISES Odace - Courant



DÉSIGNATION	UT	CODE	PPHT (€)	ECOPART (€)
880.0005.20 PRISE DE COURANT 2P+T VIS ODACE BLANC S520059	U	17304.6	6,96	0,02



PRISES Odace - Plaque de finition



DÉSIGNATION	UT	CODE	PPHT (€)
880.0002.03 PLAQUE 1P.ODACE STYL BLANC S520702	U	1730D.6	2,71
880.0004.06 PLAQUE 2P.ENTR.71MM ODACE STYL BLANC S520704	U	1730E.1	5,42



ACCESSOIRES Odace - Altira



DÉSIGNATION	UT	CODE	PPHT (€)
880.0013.14 RESSORT +OUTIL DE POSE ODACE -S10- S520299	U	1730Z.0	17,52

Le PPHT comprend l'ecopart (€)

CABLES ET CONDUITS

CABLES, FIL ET CONDUITS



CABLES

Câble rigide - U-1000 R2V



	DÉSIGNATION	UT	CODE	PPHT (€)
000.0093.38	CABLE RIGIDE U1000 R2V 7G1.5 50M CBP01361300	U	310TR.5	93,38



CONDUIT

Mureva - Coude pour Tube PVC - IP40



	DÉSIGNATION	UT	CODE	PPHT (€)
906.0197.07	COUDE P.TUBE GT 3321 MUREVA 20MM B50 IMT43320	U	173PA.3	262,76



CONDUIT

Mureva - Équerre pour Tube PVC - IP40



	DÉSIGNATION	UT	CODE	PPHT (€)
906.0081.60	EQUERRE P.TUBE 3321 16MM GRIS B50 ENN42316	U	173PG.0	108,80



ACCESSOIRE

Mureva Fix - Instactable pour conduits



	DÉSIGNATION	UT	CODE	PPHT (€)
880.0057.11	INSTACABLE P.CONDUITS 16-32 GR.-100- ENN47930	U	173PL.1	57,11

PROTECTION ET DISTRIBUTION

DISTRIBUTION ET GESTION DE L'ENERGIE



PROTECTION

Resi9 XP système de protection - Interrupteur différentiel



	DÉSIGNATION	UT	CODE	PPHT (€)	ECOPART (€)
880.0114.86	INTERRUPTEUR DIFF.2P 40A A RESI9 XP R9PRA240	U	173R2.9	153,16	0,02
880.0182.03	INTERRUPTEUR DIFF.2P 63A A RESI9 XP R9PRA263	U	173R5.2	242,73	0,02
880.0084.52	INTERRUPTEUR DIFF.2P 40A AC RESI9 XP R9PRC240	U	173R6.0	112,71	0,02
880.0159.56	INTERRUPTEUR DIFF.2P 63A AC RESI9XP R9PRC263	U	173R7.8	212,76	0,02



PROTECTION RESIDENTIELLE

Resi9 XP système de protection - Interrupteur différentiel



	DÉSIGNATION	UT	CODE	PPHT (€)	ECOPART (€)
880.0121.36	INTERRUPTEUR DIFF.2P 25A AC RESI9 XP R9PRC225	U	242LJ.6	121,38	0,02



COMMANDE MODULAIRE RESIDENTIELLE

Resi9 XP système de distribution - Disjoncteur modulaire



	DÉSIGNATION	UT	CODE	PPHT (€)	ECOPART (€)
880.0020.47	DISJONCTEUR MODUL.1P+N 10A RESI XP R9PFC610	U	173QY.5	27,31	0,02
880.0020.47	DISJONCTEUR MODUL.1P+N 16A RESI XP R9PFC616	U	173QZ.4	27,31	0,02
880.0020.47	DISJONCTEUR MODUL.1P+N 20A RESI XP C R9PFC620	U	173R0.3	27,31	0,02
880.0026.26	DISJONCTEUR MODUL.1P+N 32A RESI XP C R9PFC632	U	173R1.1	35,04	0,02
880.0040.46	DISJONCTEUR MODUL.1P+N 16A RESI XP D R9PFD616	U	201SG.6	40,48	0,02
880.0040.46	DISJONCTEUR MODUL.1P+N 20A RESI XP D R9PFD620	U	201SH.4	40,48	0,02
880.0047.99	DISJONCTEUR MODUL.1P+N 25A RESI XP D R9PFD625	U	201SJ.1	48,01	0,02
880.0060.44	DISJONCTEUR MODUL.1P+N 32A RESI XP D R9PFD632	U	201SK.9	60,46	0,02
880.0040.46	DISJONCTEUR MODUL.1P+N 10A RESI XP D R9PFD610	U	216F1.4	40,48	0,02



COMMANDE MODULAIRE RESIDENTIELLE

Resi9 XP système de distribution - Peigne monobloc



	DÉSIGNATION	UT	CODE	PPHT (€)	ECOPART (€)
906.0009.12	PEIGNE MONOBLOC 1P+N 63A 13M 5M R9PXH213R	U	173R8.6	12,18	0,02



COFFRET

Coffret de répartition - Kaedra mini



	DÉSIGNATION	UT	CODE	PPHT (€)
880.0087.71	MINI COFFRET KAEDRA 4M 123X200 ETANCHE 13957	U	242PW.3	87,71

Le PPHT comprend l'ecopart (€)

Les tarifs et disponibilités de nos produits peuvent évoluer sans préavis

RICHARDSON

395

PROTECTION ET DISTRIBUTION

DISTRIBUTION ET GESTION DE L'ENERGIE



COFFRET

Coffret de répartition - Kaedra mini
- suite



	DÉSIGNATION	UT	CODE	PPHT (€)
880.0101.55	MINI COFFRET KAEDRA 6M 159X200 ETANCHE 13958	U	242PZ.8	101,55



COFFRET

Coffret de répartition - Opale mini



	DÉSIGNATION	UT	CODE	PPHT (€)
880.0011.11	MINI COFFRET OPALE 4 PAS 2 MOD 13392	U	205Z4.7	11,11
880.0009.63	MINI COFFRET OPALE 8 PAS 4 MOD 13394	U	205Z5.4	12,84

Pour plus d'infos,
consultez
le CAHIER TECHNIQUE
page 14

PHOTOVOLTAIQUE

FIXATIONS PHOTOVOLTAIQUES



ACCESSOIRES

FIXATION CROCHET TUILE -
SingleHook 4S



	DÉSIGNATION	UT	CODE	PPHT (€)
000.0022.10	FIXATION CROCHET TUILE 4S K2SYS -1- 2003144	U	A08U0.6	22,10



ACCESSOIRES

FIXATION MICRO-ONDULATEUR - Kit StairPlate



	DÉSIGNATION	UT	CODE	PPHT (€)
000.0007.36	ACCESSOIRE FIX.MICRO OND. K2SYS -1- 2004057	U	A08TP.7	7,36



ACCESSOIRES

FIXATION TIREFOND - Vis à double filetage SingleRail
M10x250



	DÉSIGNATION	UT	CODE	PPHT (€)
000.0011.44	FIXATION TIREFOND.M10X200 BOIS K2SYS 1- 2003273	U	A08U4.8	11,44



ACCESSOIRES

ÉTRIER UNIVERSEL - K2 Clamp MC 25-40 mm
noir anodisé



	DÉSIGNATION	UT	CODE	PPHT (€)
999.0005.78	PINCE INTERMED.NOIR HYB 25-40 K2SYS-1 2004148	U	A0950.4	5,78



ACCESSOIRES

ÉTRIER UNIVERSEL - OneEnd, noir anodisé



	DÉSIGNATION	UT	CODE	PPHT (€)
000.0005.65	PINCE EXTREMITE NOIRE 30-42 K2SYS -1- 2002589	U	A08U0.1	5,65

PHOTOVOLTAIQUE

FIXATIONS PHOTOVOLTAIQUES



ACCESSOIRES

MISE À LA TERRE TERRAGRIF - QL



	DÉSIGNATION	UT	CODE	PPHT (€)
000.0004.21	MISE A LA TERRE TERRAGRIF QL K2SY.-1- 2004231	U	A08U8.9	4,21



ACCESSOIRES

RAIL SIMPLE



	DÉSIGNATION	UT	CODE	PPHT (€)
999.0042.10	RAIL SIMPLE 36-2,25M K2 K2SYS -1- 2003220	U	A0952.0	42,10



ACCESSOIRES

VIS BOIS AUTOFOREUSE - Ø 8



	DÉSIGNATION	UT	CODE	PPHT (€)
566.0001.18	VIS BOIS AUTO-FOR. M8/100 K2SYS 2004112	U	A04DJ.6	1,18

KIT DE TRANSFORMATION

2 RANGÉES



	DÉSIGNATION	UT	CODE	PPHT (€)
000.0045.04	KIT TRANSFORMATION 2 RANGEES IZI PV	U	402PN.0	60,05

RAIL DE FIXATION



	DÉSIGNATION	UT	CODE	PPHT (€)
000.0386.57	RAIL DE FIXATION IZI PV -BOITE B- 301069	U	A017T.1	644,28

PHOTOVOLTAIQUE

ONDULEURS ET CONNECTIQUES



IQ CABLE

Câble monophasé - Paysage

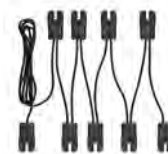

	DÉSIGNATION	UT	CODE	PPHT (€)
566.0047.65	CABLE MONO.PAYSAGE 2M ENPHASE Q-25-17-240	U	A04C5.6	47,65



IQ CABLE

Câble monophasé - Portrait



	DÉSIGNATION	UT	CODE	PPHT (€)
566.0033.00	CABLE MONO PORTRAIT 1.3M ENPHASE Q-25-10-240	U	A04BX.1	33,00



IQ CABLE

EMBOUT DE TERMINAISON - Monophasé



	DÉSIGNATION	UT	CODE	PPHT (€)
000.0030.52	EMBOUT TERMINAIS.MONO ENPHASE -1- Q-TERM-R	U	A08TZ.7	30,52



IQ CABLE

EMBOUT DE TERMINAISON - Triphasé



	DÉSIGNATION	UT	CODE	PPHT (€)
000.0034.73	EMBOUT DE TERMIN.TRI.ENPHASE -1- Q-TERM-3P	U	A08TX.0	34,73



IQ DISCONNECT

OUTIL DE DÉCONNEXION



	DÉSIGNATION	UT	CODE	PPHT (€)
000.0006.31	OUTIL DECONNEXION MONO ENPHASE -1- Q-DISC	U	A08UF.3	6,31

KIT PHOTOVOLTAIQUES



KIT AUTOCONSO



	DÉSIGNATION	UT	CODE	PPHT (€)
000.3410.18	KIT AUTOCONSO APS 3000W 384030	U	A017S.3	5683,64

NOTES

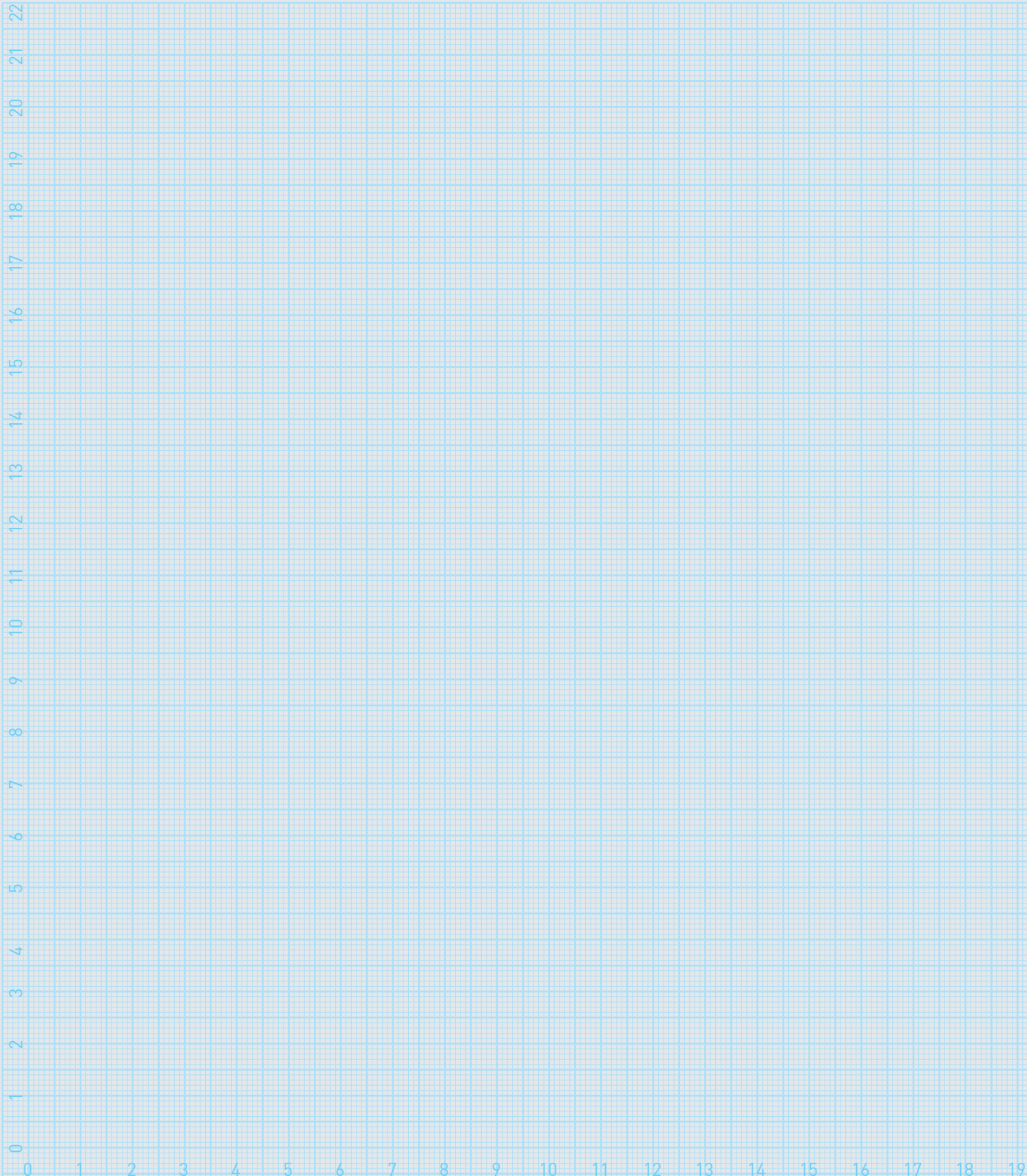

CONDITIONS GÉNÉRALES DE VENTE

Sauf dérogation expresse, les présentes conditions, contractuellement acceptées, font la loi des parties et sont soumises à la force obligatoire due aux conventions.

A - COMMANDE ET EXÉCUTION

Toute commande implique de la part du client l'acceptation sans réserve des présentes conditions générales de vente, sauf stipulation dérogatoire contraire convenue par écrit avec le client.

Toute commande ou vente est soumise aux usages de notre profession et aux présentes conditions.

Aucune commande ne pourra être annulée partiellement ou totalement en cours d'exécution.

Nos délais de livraison ne sont donnés qu'à titre indicatif et nous ne pourrions en aucun cas être tenus à une indemnité quelconque en cas de retard. Le retard de livraison ne peut entraîner l'annulation de la commande.

Les commandes sont, sauf stipulations contraires, exécutées en qualité courante, avec les tolérances d'usage sans aucune responsabilité de notre part quant à l'emploi auquel l'acheteur les destine.

B - LIVRAISONS - TRANSPORT

La livraison est effectuée par remise de la marchandise à l'acheteur ou par simple avis de mise à disposition, ou par délivrance à un expéditeur dans les locaux du vendeur. Si l'expédition est retardée par la volonté de l'acheteur, et que le vendeur y consente, la marchandise est entreposée aux frais et risques de l'acheteur, sans responsabilité pour le vendeur.

Nos marchandises voyagent aux risques et périls du client lorsque les ventes à l'exportation sont conclues avec un incoterm 2010 en « E » et « F » ou « C » (ventes au départ) et nous supportons les risques pour les ventes conclues avec un incoterm 2010 en « D » (ventes à l'arrivée). Il appartient au client, en cas d'avaries ou de manquant, de faire toutes constatations nécessaires et de confirmer ses réserves par lettre recommandée avec avis de réception auprès du transporteur dans les trois jours qui suivent la réception des marchandises. À défaut, le destinataire est responsable de la perte des recours contre le transporteur.

C - PRIX - FACTURATION - PAIEMENT

Nos prix peuvent être modifiés sans préavis, même en cours d'exécution d'une commande à livraisons fractionnées.

Le montant de chaque facture comprend des frais de facturation et le cas échéant, des frais de livraison. Les marchandises vendues ne sont, par principe, pas reprises. Le cas échéant, et à titre exceptionnel, Les reprises consenties donneraient lieu à une retenue de 20 % du prix. Sauf accord dérogatoire, nos factures sont payables au comptant lors de la mise à disposition ou de la livraison. Aucun escompte n'est accordé. La validité des avoirs éventuels est limitée à 6 mois à compter de leur date d'établissement. En l'absence de dispositions spécifiques, le règlement de nos factures ne peut dépasser 45 jours fin de mois ou 60 jours date d'émission de la facture. Contestation / incident de paiement = Toute contestation concernant la facturation devra être formulée par écrit dans les 15 jours à compter de la réception de la facture par le client, sous peine d'irrecevabilité. En cas de défaut de paiement à l'échéance ou de refus d'acceptation de nos effets de commerce ; (i) l'intégralité de nos créances deviendra exigible, sans mise en demeure préalable ; (ii) nous nous réservons la possibilité de compenser nos dettes avec nos créances, et ce quelles que soient les échéances des unes et des autres ; (iii) nous pourrions suspendre et/ou résoudre tout ou partie des commandes en cours, sans préjudice de nos recours en dommages et intérêts, sans réponse et action corrective du client dans un délai de 5 jours ouvrés à compter de la réception d'une lettre recommandée avec accusé de réception adressée au client ; (iv) le client devient débiteur de plein droit à notre égard d'une indemnité forfaitaire pour frais de recouvrement de 40 €, à laquelle s'ajoute les intérêts de retard courant d'office dès la date de l'échéance impayée (référence faite au taux appliqué par la Banque centrale Européenne majoré de 10 points). Les frais de toute procédure contentieuse seront à la charge du client nonobstant l'application d'une clause pénale de 10 % de la créance à recouvrer, avec un minimum de 500 €. Garantie de paiement = Nous nous réservons la possibilité – dans le cadre de l'exécution d'un marché ou d'une commande à exécution successive, et en considération de la situation financière du client – de lui demander un règlement comptant ou une garantie de paiement du prix des marchandises livrées ou à livrer.

Annulation de commande = En cas d'annulation unilatérale de la commande par le client et avant toute livraison, nous conserverons les sommes versées par le client, à titre d'indemnisation forfaitaire du préjudice consécutif à l'annulation.

D - RÉSERVE DE PROPRIÉTÉ

Le transfert de propriété des marchandises vendues est suspendu jusqu'au paiement intégral du prix par l'acquéreur, sans que celui-ci puisse s'en prévaloir pour refuser le paiement à l'échéance.

E - GARANTIE RESPONSABILITÉ

Le client s'engage à respecter toutes les lois et réglementations applicables, et notamment celles portant sur le contrôle des exportations. À moins qu'il n'en soit convenu autrement lors de l'acceptation de la commande ou par application d'une disposition légale, les marchandises fournies et acceptées ne sont pas reprises ni échangées. Il appartient au client de reconnaître l'état des

merchandises avant de procéder au déchargement, et de formuler, le cas échéant, toute réserve sur le bordereau de livraison et confirmer lesdites réserves auprès du transporteur par LRAR dans les 3 jours qui suivent la livraison.

En cas de livraison non conforme à un client, toute réclamation doit nous être adressée par LRAR dans les 8 jours qui suivent la livraison de la marchandise. Les réclamations concernant la non-conformité apparente de nos marchandises ne sont prises en considération qu'avant toute pose ou installation. Il appartient au client de prendre connaissance de l'étiquetage du produit, des fiches techniques, des préconisations d'installation et de toute mention présente sur le produit ou son emballage avant la pose ou l'installation du produit. Pour les fournitures de certains matériaux (notamment : carrelage, pierre reconstituée et pierre naturelle...), les dimensions, nuances de couleur, aspect, structure, poids peuvent être soumis à des variations inhérentes à leur fabrication ou à leur nature, entrant dans les tolérances d'usage. Le stockage et la pose de bois ou produits comportant du bois nécessitent de contrôler l'hygrométrie de l'atmosphère, du support et du produit. L'étendue de nos garanties commerciales ne saurait excéder celles accordées par nos fabricants. Ces garanties sont valables sous réserve d'une utilisation conforme et normale des marchandises, du respect des prescriptions techniques et des recommandations des fabricants. Sont exclus de la garantie commerciale, le remplacement des consommables ainsi que les dysfonctionnements liés à un défaut d'entretien et/ou à l'usure normale des marchandises. En tout état de cause, notre responsabilité est limitée au montant de la commande. En cas de commande faisant l'objet de plusieurs livraisons, notre responsabilité sera limitée au montant de la partie de la commande à l'origine du litige. En tout état de cause, la limite de responsabilité s'appliquera à l'exclusion de toute autre indemnisation de quelque nature qu'elle soit et notamment à l'exclusion de l'indemnisation de tout préjudice immatériel qui serait la conséquence, directe ou indirecte, du défaut des marchandises.

F - INFORMATIONS POUR LES CLIENTS CONSOMMATEURS - GARANTIE LÉGALE DE CONFORMITÉ ET GARANTIE LÉGALE DES VICES-CACHÉS

Le client consommateur reconnaît que nous lui avons communiqué, avant la commande, le prix et les caractéristiques essentielles du produit.

Nous livrons le bien dans le délai indiqué ou, à défaut d'indication, au plus tard trente jours après la conclusion du contrat.

Nous répondons des défauts de conformité du bien, au sens des articles L.217-4 et suivants du Code de la consommation, et des défauts de la chose vendue, au sens des articles 1641 et suivants du Code civil : Article L.217-4 : « Le vendeur livre un bien conforme au contrat et répond des défauts de conformité existant lors de la délivrance. Il répond également des défauts de conformité résultant de l'emballage, des instructions de montage ou de l'installation lorsque celle-ci a été mise à sa charge par le contrat ou a été réalisée sous sa responsabilité. » Article L.217-5 : « Le bien est conforme au contrat : 1° S'il est propre à l'usage habituellement attendu d'un bien semblable et, le cas échéant : s'il correspond à la description donnée par le vendeur et possède les qualités que celui-ci a présentées à l'acheteur sous forme d'échantillon ou de modèle ; s'il présente les qualités qu'un acheteur peut légitimement attendre eu égard aux déclarations publiques faites par le vendeur, par le producteur ou par son représentant, notamment dans la publicité ou l'étiquetage ; 2° Ou s'il présente les caractéristiques définies d'un commun accord par les parties ou est propre à tout usage spécial recherché par l'acheteur, porté à la connaissance du vendeur et que ce dernier a accepté. » Article L.217-12 : « L'action résultant du défaut de conformité est prescrite par deux ans à compter de la délivrance du bien. » Article L.217-16 : « Lorsque l'acheteur demande au vendeur, pendant le cours de la garantie commerciale qui lui a été consentie lors de l'acquisition ou de la réparation d'un bien meuble, une remise en état couverte par la garantie, toute période d'immobilisation d'au moins sept jours viennent s'ajouter à la durée de la garantie qui restait à courir. Cette période court à compter de la demande d'intervention de l'acheteur ou de la mise à disposition pour réparation du bien en cause, si cette mise à disposition est postérieure à la demande d'intervention. » Article 1641 : « Le vendeur est tenu de la garantie à raison des défauts cachés de la chose vendue qui la rendent impropre à l'usage auquel on la destine, ou qui diminuent tellement cet usage que l'acheteur ne l'aurait pas acquise, ou n'en aurait donné qu'un moindre prix, s'il les avait connus. » Article 1648 al. 1 : « L'action résultant des vices rédhibitoires doit être intentée par l'acquéreur dans un délai de deux ans à compter de la découverte du vice. » Pour les clients consommateurs, il est possible de recourir à un médiateur de la consommation : CMAP ; adresse : 39 avenue Franklin D. Roosevelt 75008 PARIS ; site internet : www.cmap.fr

G - CONTENANT GAZ - MISE EN GARDE

Nous rappelons que ces contenants doivent être manipulés sans brutalité, ni choc violent. Ils ne doivent pas rester exposés au soleil, ni au grand froid, ni demeurer à proximité d'un foyer. En raison du très grave danger qui en résulte, il est formellement interdit de graisser les robinets, raccords, détendeurs ou tout autre pièce équipant nos bouteilles et récipients. Les robinets doivent être soigneusement refermés après chaque usage et en fin d'usage pour éviter les

rentrées d'air. Nous déclinons toute responsabilité en cas d'accident résultant de l'inobservation des présentes recommandations. Tout client souhaitant acheter des fluides frigorigènes ou équipements préchargés non hermétiques devra justifier qu'il bénéficie de l'attestation de capacité prévue à l'article R.543-99 du Code de l'environnement.

H - CLAUSE DE CONFIDENTIALITÉ

Les prix proposés et/ou convenus avec les clients ainsi que leurs composantes et les conditions de vente constituent des informations confidentielles relevant du secret des affaires et leur communication à des tiers est strictement interdite. En cas de violation, nous réclamerons une indemnité compensatrice.

I - DONNÉES PERSONNELLES

Nous effectuons traitement relatif à la gestion des clients concernant les contrats, les commandes, les livraisons, les factures, la comptabilité, et en particulier la gestion des comptes clients, le suivi de la relation client. Les bases légales du traitement sont les articles 6 (1) b, 6 (1) c et 6 (1) f du règlement général sur la protection des données du 25 mai 2018. Les données collectées peuvent être : nom, prénom, fonction service, langue, date de naissance, courriel, téléphone, fax, portable. Le traitement ne donne lieu à aucun transfert des données hors de l'Union Européenne. Les données sont conservées conformément aux durées légales de conservation en assurant leur sécurité, leur confidentialité et leur intégrité.

Le client dispose d'un droit d'information, d'accès, de rectification, d'un droit à l'effacement et de portabilité sur les données le concernant ainsi que d'un droit de demander la limitation ou de s'opposer au traitement. Ce droit peut être exercé en écrivant au siège de notre société.

J - CORRUPTION ET TRAFIC D'INFLUENCE

Le client s'engage à respecter les lois et réglementations applicables en matière de lutte contre la corruption et le trafic d'influence dans l'exécution de ses obligations, et plus particulièrement la loi sur la transparence, la lutte contre la corruption et la modernisation de la vie économique du 9 décembre 2016.

Il s'interdit en conséquence de faire tout ce qui pourrait causer à notre Société d'être en violation des règles anti-corruption et devra protéger, indemniser et garantir notre Société de toutes amendes, pertes et dettes contractées par notre Société à la suite de manquement du client de se conformer à ces règles.

K - ADHESION AUX ECO-ORGANISMES

La Société RICHARDSON est enregistrée auprès des éco-organismes en charge des différents types de produits et matériaux dont elle est metteur sur le marché sous les identifiants uniques suivants : REP Eléments d'ameublement (DEA) : FR025872_10KXLO ; REP Articles de Bricolage et de Jardin (ABJ) : FR025872_14R2YB ; REP Produits et Matériaux de Bâiment et de Construction (PMCB) : FR025872_04MWT ; REP Papiers Graphiques : FR025872_03KEYZ. Ces numéros garantissent que la Société RICHARDSON se met en conformité avec les obligations réglementaires qui lui incombent en application de l'article L.541-10-1 du Code de l'Environnement.

L - DROIT APPLICABLE ET ATTRIBUTION

DE JURIDICTION

Les présentes conditions sont régies par le droit français, ainsi que les usages en vigueur au jour de la commande.

Pour toutes contestations relatives aux présentes, les parties font attribution de juridiction et de compétence au Tribunal de Commerce de Marseille, qui sera seul compétent pour en connaître, même en cas d'appel en garantie ou de pluralité de défendeurs.

MEDIATION

Pour les clients non professionnels, le médiateur est CMAP ; adresse : 39 Avenue Franklin D. Roosevelt 75008 Paris ; site internet : www.cmap.fr ; mail : cmap@cmmap.fr.

AVERTISSEMENT

Les articles présentés dans ce catalogue sont susceptibles d'être modifiés suivant leur évolution technique ou notre propre référentiel les prix mentionnés sont donnés à titre indicatif, ils s'entendent en euros HT, hors frais de livraison ; ils peuvent être modifiés sans préavis. Ce sont des prix publics indicatifs des fabricants à la date de sortie du document et soumis aux variations tarifaires de ces derniers. Les garanties des produits présentés dans ce catalogue sont celles des fabricants (se référer à leur documentation). Les prix indiqués dans ce catalogue incluent les taxes éco-participations.

Toutes les photos et illustrations sont données à titre indicatif et sont non contractuelles. Certaines ont été communiquées par nos fournisseurs et restent leur propriété. Descriptifs et prix valables sous réserve d'erreurs typographiques et sous réserve des dispositions légales en vigueur. Ces informations ne sauraient en aucun cas engager la responsabilité de la société RICHARDSON.

RICHARDSON

Siège Social : 2 Place Gantès, 13002 Marseille
tél. : 04 91 51 48 00 - fax : 04 91 91 38 58

www.richardson.fr

SAS au capital de 15 300 000 euros RCS marseille 054 800 958 - APE 4674B n° tva intracommunautaire : FR 11 054 800 958

LA LIVRAISON 100% SUR MESURE C'est vous qui commandez !



LIVRÉ SUR VOTRE **CHANTIER**

Du lundi au vendredi

Passez vos commandes

- Avant 11h30 (cde fax, tél. et web)

Pour livraison le lendemain

RETRAIT EN **MAGASIN**

Votre commande à J+0 en passant directement à l'agence.

NOS HORAIRES SONT PRÉVUS POUR VOUS
Ouverture dès 7h30 !

Tournées de livraisons en 9 secteurs

lundi

mardi

mercredi

jeudi

vendredi

MARSEILLE SUD NORD

Allauch, Aubagne, Gemenos, La penne sur huveaune, Marseille, Plan de Cuques

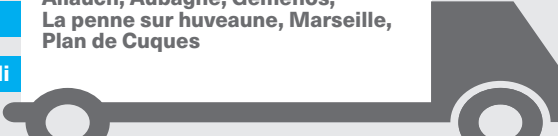

lundi

mardi

mercredi

jeudi

vendredi

MARTIGUES ETANG SUD

Carry, Chateauneuf Les M, Ensues, Entressen, Fos, Gignac, Istres, La couronne, Lavera, Le Rove, Martigues, Miramas, Pas de Lanciers, Port de Bouc, Port St Louis, Sausset, St Mitre les ramparts



lundi

mardi

mercredi

jeudi

vendredi

PAYS DE L'ETOILE

Auriol, Belcodene, Cadolive, Chateauneuf Le R, Cuges, Fuveau, Greasque, La Bouilladisse, La Destrousse, Mimet, Nans les pins, Peynier, Peypin, Plan d'Aups, Pont de l'étoile, Roquevaire, Rousset, St Savournin, St Zacharie, Trets



lundi

mardi

mercredi

jeudi

vendredi

SALON

Alleins, Aureille, Arles, Aurons, Charleval, Cornillon Confoux, Coudoux, Eygalières, Eyguières, Grans, La Barben, La fare les O, La Roque d'A, Lamanon, Lancon, Les Baux de Pce, Mallemort, Maussane les A, Mouries, Pelissanne, Pont Royal, Salon, Senas, St Esteve de J, St Martin de C, Vernergues



lundi

mardi

mercredi

jeudi

vendredi

GARDANNE

Bouc Bel Air, Cabries, Calas, Gardanne, Plan de Campagne, Simiane



lundi

mardi

mercredi

jeudi

vendredi

VITROLLES MARIGNANE

Berre, Les pennes Mirabeau, Marignane, Rognac, Septèmes Les vallons, St Chamas, St Victoret, Velaux, Vitrolles



lundi

mardi

mercredi

jeudi

vendredi

AIX

Aix, Beaurecueil, Eguilles, Jouques, Lambesc, Le Tholonet, Les Milles, Luynes, Meyrargues, Meyreuil, Peyrolles, Puy St Réparate, Rognes, St Cannat, St Marc de Jaumegar, Vauvenargues, Venelles, Ventabren

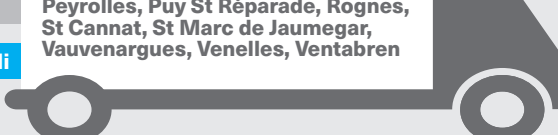

lundi

mardi

mercredi

jeudi

vendredi

AVIGNON

Avignon, Barbentane, Boulbon, Cabannes, Chateaurnard, Eyragues, Graveson, Maillane, Mollèges, Noves, Orgon, Plan d'Orgon, Rognonas, St Andiol, Tarascon



lundi

mardi

mercredi

jeudi

vendredi

VAR CIOTAT

Bandol, Belgentier, Carnoux, Carqueiranne, Cassis, Ceyreste, Cuers, Hyères, La Bedoule, La Cadière, La Ciotat, La Crau, La Farlède, La Garde, La Seyne, La Valette, Le Beausset, Le Castellet, Le Pradet, Le Revest Les E, Meounes, Ollioules, Pierrefeu, Roquefort La B, Sanary, Six Fours, Sollies P, Sollies T, Sollies V, St Cyr, St Mandrier, Toulon *

*Signes : Lundi et Mercredi



Pour COMMANDER

Scannez
avec l'appli mobile

Cliquez
www.richardson.pro

Envoyez
un mail

Téléphonez

Faxez



AUBAGNE 
1710 Route Nationale 8 - Le Charrel - 13400 AUBAGNE
04 42 18 15 00
Fax 04 42 03 93 51
courrier.aubagne@richardson.fr

HORAIRES
Magasin et libre service :
Du lundi au vendredi de 7h30 à 12h
et de 13h30 à 17h
Salle d'exposition :
Du lundi au vendredi de 9h à 12h
et de 13h30 à 18h00

MARSEILLE - JOLIETTE 
2 Place Gantès - 13002 MARSEILLE
04 91 15 48 00
Fax 04 91 15 48 01
courrier.marseille@richardson.fr

HORAIRES
Magasin et libre service :
Du lundi au vendredi de 7h30 à 12h
et de 13h30 à 16h30.
Salle d'exposition :
Du lundi au vendredi de 9h à 12h et de 13h30 à 18h.

MARSEILLE - LA CAPELETTE
29-31 Rue Gustave Eiffel - 13010 MARSEILLE
04 91 80 07 94
Fax 04 91 25 81 99
courrier.capelette@richardson.fr

HORAIRES
Agence :
Du lundi au vendredi de 07h à 12h
et de 13h30 à 16h30.
Parking réservé à la clientèle disponible

MARSEILLE - LES AYGALADES
Parc Lavoisier Bat C - 99 Av Ibrahim Ali - 13015 MARSEILLE
04 91 43 43 85
Fax 04 91 43 43 89
courrier.aygalades@richardson.fr

HORAIRES
Agence :
Du lundi au vendredi de 07h30 à 12h
et de 13h30 à 16h30.

LA CIOTAT 
27 Av de la Sariette - Athelia II - 13600 LA CIOTAT
04 42 08 09 41
Fax 04 42 71 68 36
courrier.laciotat@richardson.fr

HORAIRES
Agence et Salle d'Exposition :
Du lundi au vendredi de 07h30 à 12h
et de 13h30 à 17h.

AIRÉO CAPELETTE
49 Avenue Benjamin Delessert, rue Roumanin, La Capelette
13010 MARSEILLE
04 65 57 72 26
courrier.capelette@aireo-pro.fr

HORAIRES
Agence :
Du lundi au vendredi de 07h30 à 12h et de 13h30 à 16h30.
Présence d'un parking.

